



Ministry of Housing and Urban Affairs
Government of India



CIRCULAR ECONOMY

in Municipal Solid and Liquid Waste



Circular Economy

in Municipal Solid and Liquid Waste



दुर्गा शंकर मिश्र

सचिव

Durga Shanker Mishra

Secretary



सत्यमेव जयते



एक कदम स्वच्छता की ओर

भारत सरकार

आवासन और शहरी कार्य मंत्रालय

निर्माण भवन, नई दिल्ली-110011

Government of India

Ministry of Housing and Urban Affairs

Nirman Bhawan, New Delhi-110011



FOREWORD

Scientific management of municipal waste has been one of major thrust areas in urban India under the national flagship Missions such as Swachh Bharat Mission-Urban and AMRUT. However, despite SBM-U's focus on the principles of 3R (reduce, reuse, recycle) being implemented with active engagement of citizens, there is still considerable scope to recover value from waste.

This is possible by adopting a circular economy approach which is central to achieving the vision of a clean India. Circular economy solutions are embedded in the concept of generating zero waste through innovations that can utilise discarded materials to produce reusable and recyclable products. This is not new to our society as since ancient times we have been practising the principles of conserving natural resources and protecting the environment.

This extensive report examines three different categories of municipal solid waste, viz. dry waste, wet waste and construction & demolition waste, and two categories of municipal liquid waste, viz. wastewater and municipal sludge, to suggest practical and concrete steps towards circular economy.

I would like to thank Shri Kamran Rizvi, Additional Secretary, MoHUA under whose overall direction this Report has been finalized. I also thank the chairpersons of each of the sub-committees – Shri Prabhjot Sodhi for dry waste, Shri Syed Asad Warsi for wet waste, Shri Bibekananda Mohapatra for C&D waste, Shri Rajesh Biniwale for wastewater, and Dr. V.K. Chaurasia for municipal sludge - who have put together the report after in-depth discussions with multiple stakeholders, despite limitations imposed by Covid-19 pandemic. I would like to acknowledge the hard work put in by the SBM-U Program Management Unit (PMU) under the guidance of Shri Binay Kumar Jha, Director SBM.

I am sure that the roadmap presented in the report can propel the country towards a new trajectory in waste management based on circular economy principles. Most importantly, the onus is on each of us to make a conscious shift in our consumption patterns in order to create a virtuous cycle of recovering value from waste that ensures a better, brighter future for our next generations.

(Durga Shanker Mishra)

New Delhi

30 June, 2021

Executive Summary

Executive Summary

This report attempts to provide a comprehensive, implementable and forward-looking action plan for the management of municipal solid & liquid waste. It also aims to promote India's transition from a linear 'take-make-waste' mindset to a multi lifecycle circular approach.

The report has been divided into five key chapters focusing on dry waste, wet waste, construction and demolition waste, wastewater and municipal sludge. Each chapter highlights current scenario, identifies key challenges, gaps in policy framework & regulations, showcases best practices and makes recommendations for moving towards circular economy.

I. Dry Waste

Dry waste is the most valued waste stream in municipal solid waste owing to high economic value of its components, especially recyclables. India currently generates approximately 1.45 lakh metric tonnes of solid waste per day, 35% of which is dry waste. It consists of different components such as plastic, paper & cardboard, glass & ceramic, metals, textiles, tyres & rubbers, etc. Currently, lack of comprehensive methods for plastic waste management, limited collection & recycling of single use plastic and unscientific methods of recycling by informal sector pose some of the key challenges in this area. Along with this, policy & regulatory gaps such as lack of incentives to encourage recycled products and complex EPR frameworks, amongst others, have inhibited the potential of dry waste in the circular economy.

The sub-committee recommends (i) a comprehensive policy on mandatory use of certain percentage of recycled material in lieu of virgin material, (ii) expeditious implementation of EPR framework and (iii) rebate in tax/ GST on recycled products to increase its competitiveness.

II. Wet Waste

Wet waste, also known as biodegradable waste, includes cooked and uncooked food, waste from fruits and flowers, fallen leaves, and other similar things. Till now, wet waste processing has predominantly relied on aerobic composting and is yet to leverage the advantages of bio-methanation to its fullest. Bio-methanation can be significantly more profitable than traditional composting, especially for towns/ clusters having population of 3 lakhs and above, provided a conducive market is created for the usage of its end-products.

The key to the success of circularity in wet waste lies in effective source segregation of waste. The sub-committee also suggests (i) unbundling of sanitary landfills from SWM functions, (ii) relaxation of environmental clearance for waste processing plants and (iii) incentivizing of biogas plants through SATAT.

III. Construction and Demolition Waste

C&D waste generation normally varies from 5-25% of the MSW generated in ULBs. However, due to inadequate capacity of C&D waste processing facilities, material value of C&D waste is lost into landfills, causing huge environmental and economic losses.

C&D waste management helps to suppress dust generation, thus significantly reducing air pollution. Additionally, it conserves precious resources and minerals and helps in promoting use of recycled products for construction & other infrastructural projects.

Complete circularity in C&D waste management can be achieved by implementing a comprehensive strategy and action plan covering the lifecycle of construction projects, including dismantling phase. The sub-committee recommends (i) reduction in virgin construction raw material usage in different building projects and (ii) extending tax rebates on recycled C&D products.

IV. Wastewater

Water demand is set to increase with India's rapidly growing urban population. This, however, is not matched by corresponding increase in water resources. Wastewater recycling and reuse offers a reliable, long-term source of water supply to help meet non-potable water demand.

The sub-committee recommends creation of adequate sewage treatment capacity to meet the requirement of sewage generation in a time-bound manner. It also recommends targets for recycle and reuse of treated wastewater in the short, mid and long-term, at 25% by 2026, 35% by 2036 and 50% by 2050 respectively. The sub-committee recommends (i) preparation of new standards for designated reuse, (ii) framing of Wastewater Reuse policy by States/ UTs, (iii) creation of institutional mechanism to promote circular economy in wastewater and (iv) mandatory use of recycled water in industries, especially in thermal power plants.

V. Municipal Sludge

Approximately 60% of India's population is dependent on on-site sanitation systems and remaining 40% on off-site systems. Sludge is generated from both systems and needs to be managed appropriately, with minimal adverse effects on the environment. Sludge utilisation in India is currently being done in an unscientific manner without adequate regulatory standards, which leads to indiscriminate sludge disposal on land and in water bodies. Due to low levels of awareness, the by-products of sludge have low market demand.

The report attempts to demonstrate how treated sludge can be utilised as a resource. To realize this objective, the sub-committee recommends (i) introducing national policy on sludge reuse/ recycle, (ii) introducing comprehensive standards on recycle and reuse of processed sludge and (iii) incentivising tagging of compost with chemical fertilizers and biogas with SATAT.

Table of Contents

Foreword	i
Executive Summary	ii
Table of Contents	iv
List of Figures	vi
List of Tables	viii
Chapter I: Introduction	1
Chapter II: Report of Sub-Committee on Dry waste	5
2.1 Introduction	6
2.2 Current Scenario of Dry Waste Management & Challenges	7
2.3 Potential of Dry Waste in Circular Economy	12
2.4 Gaps in Policy, Regulations and Infrastructure	13
2.5 Technology Options and Business Models	16
2.6 Recommendations	19
Chapter III: Report of Sub-Committee on Wet waste	22
3.1 Introduction	23
3.2 Current Scenario and Challenges	25
3.3 Challenges in Wet Waste Management	26
3.4 Potential of Wet Waste Management in Circular Economy	26
3.5 Technology Options and Business Viability Models	28
3.6 Recommendations and Action Plans	30
Chapter IV: Report of Sub-Committee on Construction & Demolition waste	35
4.1 Introduction	36
4.2 Current Scenario and Challenges in C&D Waste Management	38
4.3 Circularity & Potential of C&D Waste	42
4.4 Gaps in Policy & Regulatory framework in India	46
4.5 Technology Options & Business Viability Models	47
4.6 Comprehensive Action Plan & Recommendations	50

Chapter V: Report of Sub-Committee on Recycle and Reuse of Treated Municipal Sewage (Wastewater).....	56
5.1 Introduction.....	57
5.2 Potential for Circularity in Water- wastewater Sector	58
5.3 Current Approach and Challenges	59
5.4 Gaps in Policy and Regulations.....	65
5.5 Recommendations and Action Plan	70
Chapter VI: Report of Sub-Committee on Recycle and Reuse of Treated Municipal Sewage	78
6.1 Introduction.....	79
6.2 Current Scenario & Challenges	80
6.3 Potential for Circularity in Sludge	87
6.4 Gaps & Challenges in Current Approach.....	88
6.5 Technology Options	90
6.6 Recommendations and Action Plans.....	90
Chapter VII: Conclusion and Recommendations.....	94
Annexures	100
Annexure 1: Circular Economy for Dry Waste.....	101
Annexure 2: Circular Economy for Wet Waste.....	107
Annexure 3: Circular Economy for Construction & Demolition Waste.....	110
Annexure 4: Circular Economy for Recycle and Reuse of Treated Municipal Sewage (Wastewater).....	112
Annexure 5: Circular Economy for Recycle and Reuse of Treated Sludge.....	114

List of Figures

Figure 1: Value Realization Potential from Circular Business Models by 2030	3
Figure 2: Municipal Solid Waste Composition	6
Figure 3: Dry Waste Composition in MSW	7
Figure 4: Annual Per Capita Plastic Consumption	8
Figure 5: Plastic Waste Composition.....	8
Figure 6: Recyclability of Plastic Categories	9
Figure 7: Material flows in the plastic waste value chain.....	12
Figure 8: Automated MRF at Indore	17
Figure 9: Five Business models for Circular economy	17
Figure 10: Circular Economy Business models in Plastics Value Chain	18
Figure 11: Digital Intervention in Waste Management.....	18
Figure 12: Graphical representation of MSW Composition	23
Figure 13: Wet waste processing through Bio-methanation	24
Figure 14: Typical Circularity in Biomethanation Process Flow	28
Figure 15: A view of 20 TPD Bio-methanation Plant at Indore	33
Figure 16: High Rate Biomethanation Plant at Toranagallu (Bellary), Karnataka.....	33
Figure 17: 3R strategies for Construction & Demolition Waste	37
Figure 18: Composition of C&D Waste in India	39
Figure 19: Types of C&D waste	40
Figure 20: Annual generation & recovery rate of C&D waste in some countries	41
Figure 21: Challenges of C&D Waste Management.....	42
Figure 22: Circularity in C&DWM -Building life cycle with conventional method and design for deconstruction (DfD).....	43
Figure 23: C&D waste Handling in India.....	45
Figure 24: Economic Potential from C&D Waste.....	46
Figure 25: Process layout for Wet Processing of C&D waste.....	48
Figure 26: Process Steps for Dry Processing of C&D Waste	48
Figure 27: Wastewater in the water cycle (Source: WWAP)	57
Figure 28: Water in Circular Economy (Source: Water Reuse Europe Review 2018 ...	58
Figure 29: Incremental Technology interventions to achieve End Use Water Quality Standards (Source: Draft National Policy on the Safe Reuse of Treated Wastewater, India- EU Partnership).....	60
Figure 30: Aerial view of Sewage Treatment Plant	61
Figure 31: Global water reuse after advanced (tertiary) treatment: Market share by application (Source: Lautze et al. (2014)).....	61
Figure 32: EU - Timeline of regulatory initiatives relating to water reuse (Source: Water Reuse Europe Review 2018)	62
Figure 33: Water consumption pattern in water scarce state California, USA	63
Figure 34: Regulatory Framework for Wastewater Recycling & Reuse.....	64

Figure 35: Case studies of wastewater reuse projects in India	66
Figure 36: Goals set for Wastewater Recycling & Reuse.....	71
Figure 37: Composting	79
Figure 38: 345 MLD Lucknow UASB based STP along with Sludge Drying Bed	80
Figure 39: Nutrient/energy recovery from various FSTPs	80
Figure 40: Bio-Gas Plant.....	81
Figure 41: Land Application of sludge	85
Figure 42: Faecal-oral transmission of pathogen	87
Figure 43: Sludge Drying Bed	90

List of Tables

Table 1: Recommendations for Dry waste	19
Table 2: Indicative Economic Benefit for 50TPD Wet Waste Processing	27
Table 3: Types and scale of composting process	29
Table 4: Recommendations and Action Plans for Wet waste circularity	30
Table 5: C&D waste generation with respect to population categories*	40
Table 6: Benefits of C&D Waste Management.....	41
Table 7: Approaches for introducing Circularity.....	43
Table 8: Applications of C&D Waste Recycled Material	44
Table 9: Comprehensive Action Plan for C&D Waste Circularity	50
Table 10: Recommendations for C&D Waste Circularity	54
Table 11: Detailed Action Plan – National Level	72
Table 12: Detailed Action Plan – State Level and including ULBs	73
Table 13: Detailed Action Plan – National and State Level – co-ordinated	74
Table 14: Estimates for financial, economic and environmental benefits	75
Table 15: Estimates for GHG reduction.....	75
Table 16: Legal initiatives of Germany	86
Table 17: Actionable points for Recycle and Reuse of Treated Sludge.....	91



हम जो भी अपने लिए करते हैं उसका सीधा असर हमारे पर्यावरण पर भी पड़ता है। इसलिए अपने resources की efficiency को लेकर भी भारत के प्रयास बढ़ रहे हैं। आज जो Circular इकॉनामी की बात हो रही है, उसमें ऐसे प्रोडक्ट्स और ऐसे प्रोसेस पर फोकस किया जा रहा है जिनमें संसाधनों पर कम से कम दबाव पड़े। सरकार ने भी ऐसे 11 क्षेत्रों की पहचान की है जिससे हम आधुनिक टेक्नोलॉजी के माध्यम से संसाधनों को रिसाइकल करके सदुपयोग कर सकते हैं। वेस्ट टू वैल्यू यानी 'कचरे से कंचन' अभियान पर बीते कुछ वर्षों में काफी काम हुआ है और अब इसको मिशन मोड में बहुत तेजी से आगे बढ़ाया जा रहा है। घरों और खेतों से निकला कचरा हो, स्कैप मेटल हो, लिथियम आयन बैटरीज हो ऐसे अनेक क्षेत्रों में रिसाइकलिंग को नई टेक्नोलॉजी के माध्यम से प्रोत्साहित किया जा रहा है। इससे जुड़ा ऐक्शन प्लान जिस पर रेगुलेटरी और Development से जुड़े सभी पहलू होंगे इसको आने वाले महीनों में अमल में लाया जाएगा।

साथियों, जलवायु की रक्षा के लिए, पर्यावरण की रक्षा के लिए हमारे प्रयासों का संगठित होना बहुत जरूरी है। देश का एक-एक नागरिक जब जलवायु और जमीन के संतुलन को साधने के लिए एकजुट होकर प्रयास करेगा, तभी हम अपनी आने वाली पीढ़ियों को एक सुरक्षित पर्यावरण दे पाएंगे।

– प्रधानमंत्री, श्री नरेन्द्र मोदी
विश्व पर्यावरण दिवस, 5 जून 2021



Chapter I: Introduction

Introduction

".....it is our conviction that we have no right to snatch from our future generations their right to have a clean and beautiful earth. It is part of our thinking and for that reason we do not believe in exploitation of nature. We people do not have the right to take more than necessary from nature."

*—Prime Minister, Shri Narendra Modi
St Petersburg International Economic Forum, 2017*

Since time immemorial, Indian civilization has focused on conservation of resources. This has been an integral aspect of the Indian psyche and is reflected in our religious practices, folklore, art and culture permeating every aspect of the daily lives of people. The principles of sustainable development and climate consciousness can be traced back to our heritage of treating 'waste as wealth', with commodities being reused and recycled in multiple ways through a circular economy approach.

However, unprecedented levels of urbanization in India and emergence of new megacities, along with growth in population has resulted in massive increase in consumption and subsequently, generation of waste. Economic boom in India has witnessed a six-fold rise in annual material consumption between 1970 and 2015, from 1.18 billion to 7 billion tonnes, and expected to rise further to about 14.2 billion tonnes by 2030¹. This has led to a significant increase in waste generation. Efficiently managing this waste in an economically and environmentally beneficial manner poses several operational challenges and requires investment of significant resources. In this backdrop, the principles of circular economy - that integrates economic activity and environmental wellbeing in a sustainable way - are being mainstreamed now and are gaining global popularity in various fields, including in solid and liquid waste management. A typical linear economy adopts a 'take-make-waste' approach, whereas circular economy places emphasis on 'true recycling' of materials, i.e. converting the waste resource back to its original form, without sacrificing quality or integrity in the process. This, in turn, not only contributes to the development of sustainable business models but also reduces emissions and increases efficient use of natural resources.

¹ <https://www.orfonline.org/expert-speak/india-rebuilds-economy-time-make-circular-sustainable/>

Circular economy-based development approach is one of the key strategies being adopted for achieving the 2030 Agenda for Sustainable Development Goals (SDGs). The economic advantages of this model are also evident in the numbers. A recent study by Accenture suggested that India can unlock approximately half-a-trillion dollars of economic value by 2030 through adoption of Circular Economy business models. As shown in Figure 1, this can be achieved by a combination of strategies - reduction in waste generation and energy consumption, improved utilization of products/ assets, product life extension, and value recovery from waste streams.

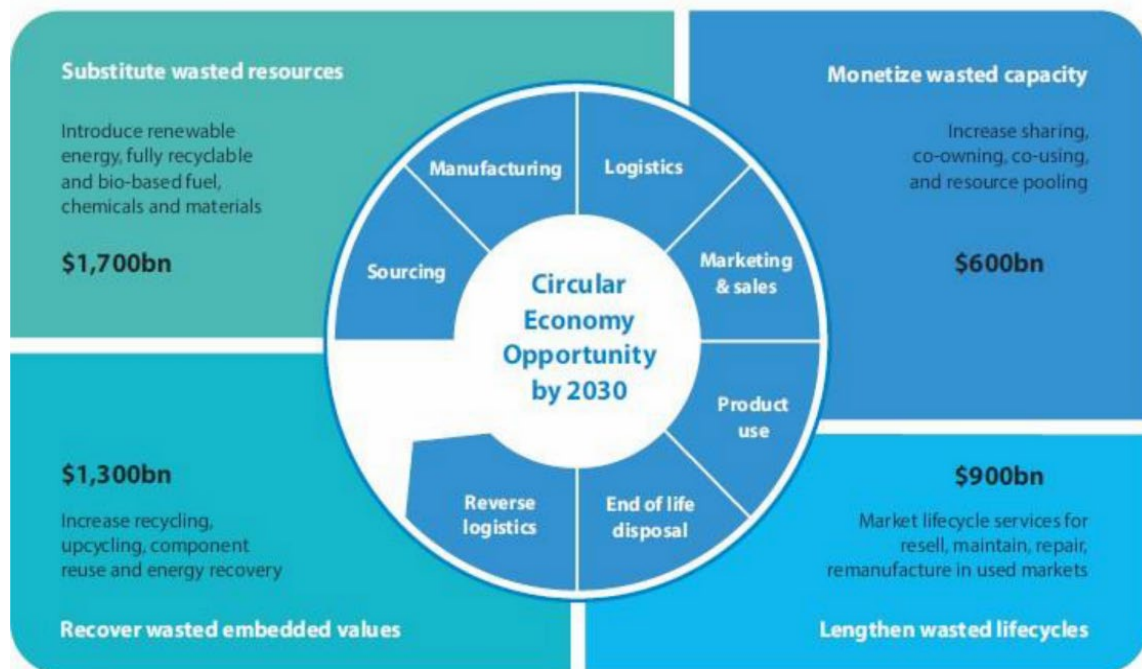

Figure 1: Value Realization Potential from Circular Business Models by 2030 (Source-Accenture 2019)

In India, an estimated 55 million tonnes of Municipal Solid Waste is generated annually by 377 million citizens residing in urban areas. India’s urban population is expected to grow to 600 million by 2030 & to 814 million by 2050. Accordingly, India is set to generate 165 million tonnes of waste by 2030 and 436 million tonnes by 2050. As a result, the annual greenhouse gas emissions from Municipal Solid Waste are expected to go up to 41.09 million tonnes by 2030². The need of the hour is therefore a development model based on the circular economy approach that looks at sustainable waste management and optimum utilization of resources - key to an AatmaNirbhar Bharat.

Municipal solid waste may be categorized into wet waste, dry waste and construction and demolition waste. An analysis by MoHUA identifies significant potential for resource recovery from these waste categories through circular economy. For example, dry waste recycling has a potential to generate approximately ₹11,836 crores per annum, and compost and Bio- CNG from wet waste can generate revenues of nearly ₹365 crores and

² <https://www.nama-facility.org/projects/india-waste-solutions-for-a-circular-economy/>

₹1,679 crores per annum respectively. Similarly, C&D waste has the potential to generate revenues of approximately ₹416 crores per annum. A similar trend is seen in the liquid waste space with revenues amounting to ₹6,570 crores and ₹3,285 crores per annum for treated sludge and wastewater respectively³.

In recent times, the Government has been actively formulating policies and promoting projects to drive the country towards a circular economy. In the area of municipal solid & liquid waste, a variety of policies and rules⁴ have been notified to encourage scientific processing of waste along with resource recovery. The circular economy agenda in municipal solid & liquid waste received significant push at the national, state and city levels with the launch of Swachh Bharat Mission-Urban (SBM-U) in 2014. The Mission built upon the foundation of the 3R principles (reduce, reuse, recycle), has been able to successfully increase urban India's solid waste treatment capacity from 18% in 2014 to 68% today (including recycling). Success stories abound with states like Chhattisgarh having attained zero-landfill status and cities like Indore practising 100% source segregation of waste. In the next phase of SBM-U, it is planned to scale up and institutionalize these processes across urban India for greater economic, environmental and social benefits.

In the backdrop of the above, NITI Aayog had identified 11 focus areas in waste generation that pose considerable challenges and need to be addressed holistically through a comprehensive circular economy framework. This report, which forms part of a larger document on '*Transitioning from a Linear to Circular Economy: An Impetus for India's AatmaNirbhar Bharat Abhiyan*' by NITI Aayog, attempts to identify and recommend financially viable and sustainable business models for reusing solid and liquid waste and thus create a conducive ecosystem for circular economy to thrive.

Municipal solid & liquid waste has been further divided into five sub-categories viz. dry waste, wet waste, construction and demolition waste, wastewater and treated sludge. Five sub-Committees were formed to give shape to the recommendations in each of the sub-categories. The study involved multiple stakeholder consultations with concerned ministries and departments, public and private sector, States and Urban Local Bodies, think tanks and industry voices. The holistic approach suggested in this report identifies challenges, opportunities, best practices and suggests an actionable roadmap for circular economy in municipal solid & liquid waste that would lead to economic, social and environmental benefits for the country. In summary, a combination of robust policies coupled with effective on-ground implementation and the commitment of people to move towards a sustainable way of life holds key to future success of waste management and circular economy programs.

³ The projections are based on the assumption of 100% segregation and processing at existing market rates

⁴ Solid Waste Management Rules 2016, Plastic Waste Management Rules 2016, Construction and Demolition Waste Management Rules 2016, Policy on Promotion of City Compost, National Faecal Sludge and Septage Management Policy 2017

Chapter 2: Report of Sub-Committee on Dry waste



2.1 Introduction

Dry waste consists of recyclables such as plastic, paper, cardboard, metals, glass, rubber, non-recyclables and other combustible. It is the most valued waste stream in municipal solid waste owing to high economic value of its components, especially recyclables. Rapid urbanization and economic growth have led to changing consumption patterns. Economic prosperity has also resulted in increase in potential value of recyclable fractions necessitating the adoption of circular economy principles for resource recovery.

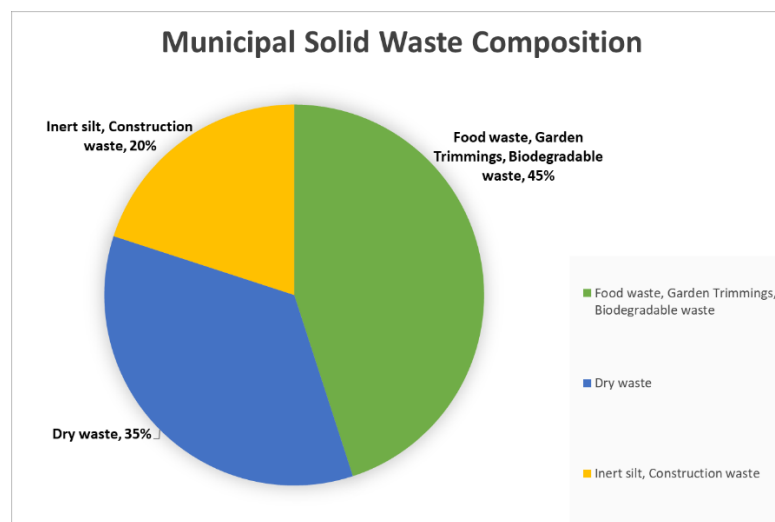

Figure 2: Municipal Solid Waste Composition

Considering India's massive domestic needs due to growing population and economic advancement, resource offsetting measures are required to reduce environmental pollution and climate change effects.

These twin challenges of dry waste management and growing resource requirements can be converted into an opportunity. Dry waste management using circularity principles can help India decouple its growth from consumption of primary resources and materials, thus ensuring efficient resource recovery from dry waste. India currently generates approximately 1.45 Lakh metric tonnes of solid waste, 35% of which is dry waste. Thanks to India's informal sector, a majority of the plastic waste is recycled. India can take inspiration from countries with high recycling rates: Germany (66.1%), Singapore (60.6%), South Korea (59.0%)⁵ and further improve its resource recovery and recycling.

This report focuses on developing a roadmap for implementing circularity principles in dry waste management and help in identifying the regulatory, policy, infrastructural and citizen-centric interventions in dry waste collection, segregation, sorting, processing and recovery of materials for reuse, thus reducing the use of virgin materials.

⁵ <https://comparecamp.com/recycling-statistics/>

2.2 Current Scenario of Dry Waste Management & Challenges

Swachh Bharat Mission (U), launched by Hon'ble Prime Minister Shri Narendra Modi in October 2014 laid out a well-defined roadmap for scientific waste management in the country. As India's waste composition is changing with increase in dry waste over the last few years and recovery potential that dry waste presents, it is vital to focus on scientific management of all dry waste components shown in the figure 3 below:

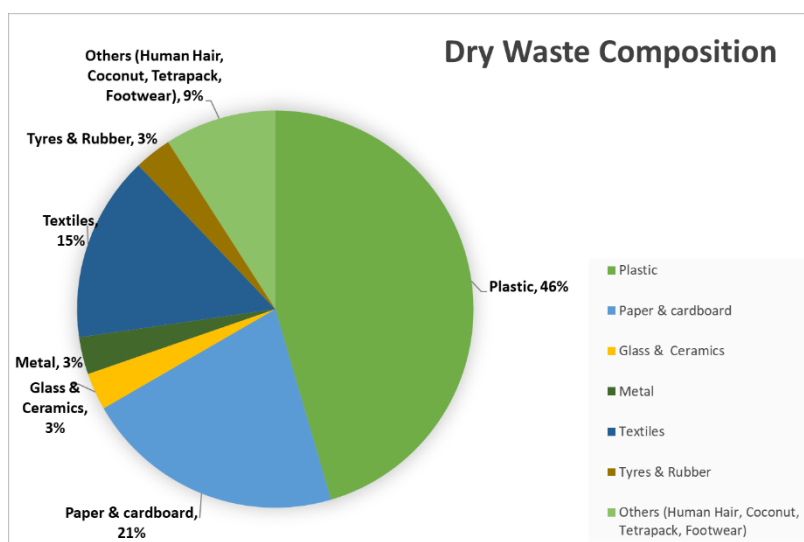

Figure 3: Dry Waste Composition in MSW

Out of dry waste components shown above, **Plastic** is the major component. India generates approximately 9.4 million tonnes per annum plastic waste, (which amounts to 26,000 tonnes per day), and out of this approximately 5.6 million tonnes per annum plastic waste is recycled (i.e. 15,600 tonnes per day) and 3.8 million tonnes per annum plastic waste is left uncollected or littered (9,400 tonnes per day)⁶. Though plastic recycling in India is almost 3 times the global average, there are no comprehensive methods in place for plastic waste management⁷. While India's per capita plastic consumption at 11 kg is much below the global average of 28 kg and just about 10% of per capita consumption in the US⁸, by 2031, plastic waste generation in India is expected to grow by more than 3 times from current levels.

⁶ Plastic Waste Management Issues, Solutions & Case Studies, MoHUA, March 2019

⁷ ibid

⁸ ibid



Source: AIPMA and PlastIndia, TATA Strategic analysis

Figure 4: Annual Per Capita Plastic Consumption

The composition of plastic waste in India among seven basic plastic categories is depicted in the figure 5⁹:

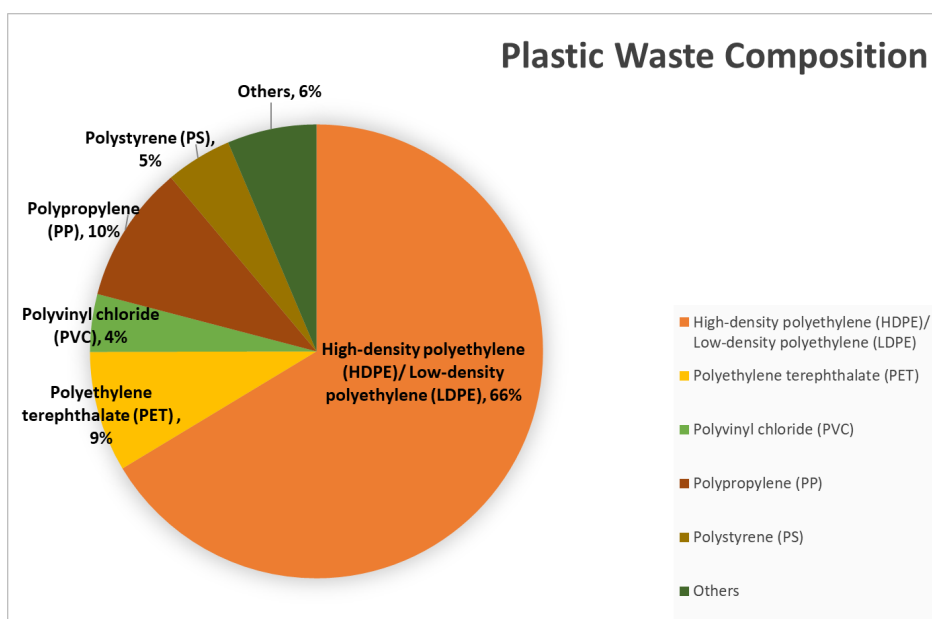

Figure 5: Plastic Waste Composition

2.2.1 Challenges in plastic waste management

- **Degradation of plastic due to recycling.** Plastic deteriorates and its life span is reduced with recycling. The recycling of a virgin plastic material can be done 2-3 times only and

⁹ CPCB 2015

recycled plastic is of lower quality than virgin plastic. Hence recycling is not a safe and permanent solution for plastic waste disposal.

- **Recyclability of Plastic Categories.** Of the 7 categories of plastics, PET bottles and HDPE are the easiest to recycle, hence leading to higher demand and more recycling of PET and HDPE products. PVC and PS on the other hand are difficult to recycle and therefore there is less collection and recycling of PVC and PS waste. Current regulations do not take these aspects into consideration leading to dumping of plastic waste into the environment, reduced recovery and recycling.

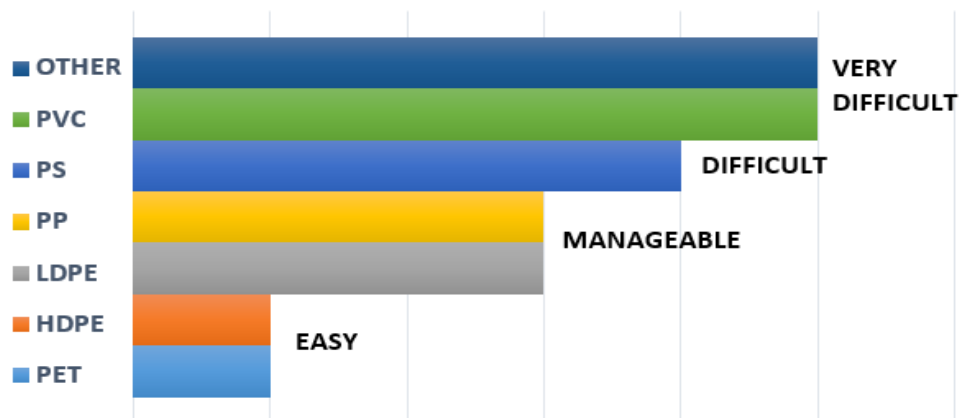

Figure 6: Recyclability of Plastic Categories

- **Collection and Recycling of Single Use Plastics (SUPs) and Multilayer & laminated plastics (MLPs)**
 - Single use plastics (SUPs) are cheap, convenient, and easily available, but over dependence on SUP items has led to manifold adverse consequences on the environment (land, air, water pollution) and society due to low economic value leading to poor collection and recycling.
 - Multilayer & laminated plastics (MLPs) include snack packets, biscuit packets etc. made from heterogeneous materials making it difficult to recycle as there are no sustainable and reliable recycling options of such materials.
- **Marine Plastic.** India is considered the twelfth-largest source of marine litter and is projected to become the fifth largest by 2025. Of the 8 million tonnes of plastic waste that ends up in the world's oceans annually, Meghna-Brahmaputra-Ganges river system dumps close to 73 thousand tonnes making it the 6th most polluting river system contributing to marine plastic waste in the world¹⁰.
- **Bioplastics.** Bioplastics are made wholly or in part from renewable biomass sources such as sugarcane and corn, or from microbes such as yeast. With the directive of banning

¹⁰ <https://www.unenvironment.org/interactive/beat-plastic-pollution/>

single use plastics, bioplastics are a good alternative to single use plastics but there are following risks and challenges with use of bioplastics:

- Significant GHG emissions from processing bio-feedstocks into plastics
- Some bioplastics are chemically identical to fossil-fuel based plastic and non-biodegradable
- Problematic if not identified and collected separately, resulting in getting mixed with recyclable plastics
- Modified recycling and recovery infrastructure required to process bioplastics

2.2.2 Challenges in Other Dry Waste Components

- i. **Processing of Tetra Pak.** Commonly used compound packaging such as Tetra Pak comprises three recyclable components i.e. 75% paper, 20% polyethylene and 5% aluminium thereby making its recycling difficult and cost intensive.
- ii. **Segregation of metals and unscientific recycling by informal sector.** Contamination of metals with bio-degradable waste is a critical matter of concern due to toxicity of metals. Though segregation of metals from other waste streams is relatively easy due to high density of metals, small metal scraps are often lost due to inefficient segregated waste collection and waste tracking, resulting in loss of valuable metal resources.
- iii. **Issues in recycling of glass and ceramic waste:** Approximately 45% of glass is recycled in India¹¹. Risks of injuries and issue of breakages while handling glass and ceramics makes it less attractive to recyclers and handlers. Though glass segregated by colours has an established market, yet lack of segregation and availability of glass is neither reported nor is there an established mechanism of communication between cities and the glass recycling industry.
- iv. **Segregated collection and processing of textile waste.** A McArthur Report estimates that globally the production of clothes has doubled in the last 15 years while the time duration for which clothing is worn before it is thrown away has fallen by approximately 40% leading to more textile waste¹². The Indian Textiles industry in India reports that more than 1 million tons of textiles are discarded every year, with most of this coming from household sources. While the industry has a recycling potential of 50%, at present only 25% is being recycled/ reused. Even though age-old circular (reuse and refurbish) barter system still exists in small towns, there is limited collection and recycling system for textiles.

¹¹ <https://greensutra.in/glass-recycling-process/>

¹² <https://www.ellenmacarthurfoundation.org/explore/fashion-and-the-circular-economy>

- v. **Processing of tyres and rubber.** With the growth of automobile sector, the tyre industry is also growing fast. It is estimated that India currently produces about 6,50,000 tyres and discards 2,75,000 every day¹³, generating over a million tonnes of ELTs (End of Life Tyres) each year¹⁴. Currently, there is no tracking of discarded tyres and monitoring of their disposal across India. Though re-treading of tyres by unorganized sector is a common practice, a large portion of the scrap tyres are dumped in landfills.
- vi. **Localized processing facilities for Thermocol.** Thermocol (Expanded polystyrene) finds wide scale application as packaging goods (especially electronic goods) and is an excellent material for the construction and decorating industry due to its insulating properties and light weight. Though it is a technically recyclable material, its transportation is a challenge due to its ultra-low density and high volume resulting in limited processing/recycling.
- vii. **Recycling of coconut waste.** With 72% of world's production in India and coconut's role in Indian culture, it is an important waste component. In recent years, due to increased demand for recycling, coconut shells are being segregated and shredded by informal workers. But in smaller and remote cities segregation, transportation and logistics cost of coconut waste act as significant barrier for coconut recycling.
- viii. **Collection and processing of human hair waste.** Despite a large-scale economy running around human hair, there is limited scientific management of human hair waste. The collection system is often limited to large generators of hair waste like large temple complexes, whereas small units generating hair waste such as salons, beauty parlours, etc. are not connected to the collection system. The efficient and environmentally safe utilization of human hair also requires appropriate technologies for different uses of hair waste.
- ix. **Coverage of Extended Producers Responsibility (EPR).** EPR has become the guiding principle as far as plastics and electronic waste management is concerned for enabling investments in the waste value chain to ensure compliance and reduce the use of virgin materials. Presently, the EPR framework in India is being developed under Plastic Waste Management Rules, 2016.

¹³ Modi 2016

¹⁴ Matade 2016

2.2.3 Challenges in mainstreaming of informal sector

Informal sector plays a major role in the making the material flow of dry waste value chain (as schematically shown in figure 7 below) resource efficient and circular by sorting the dry waste into different components and recovering valuable resources.

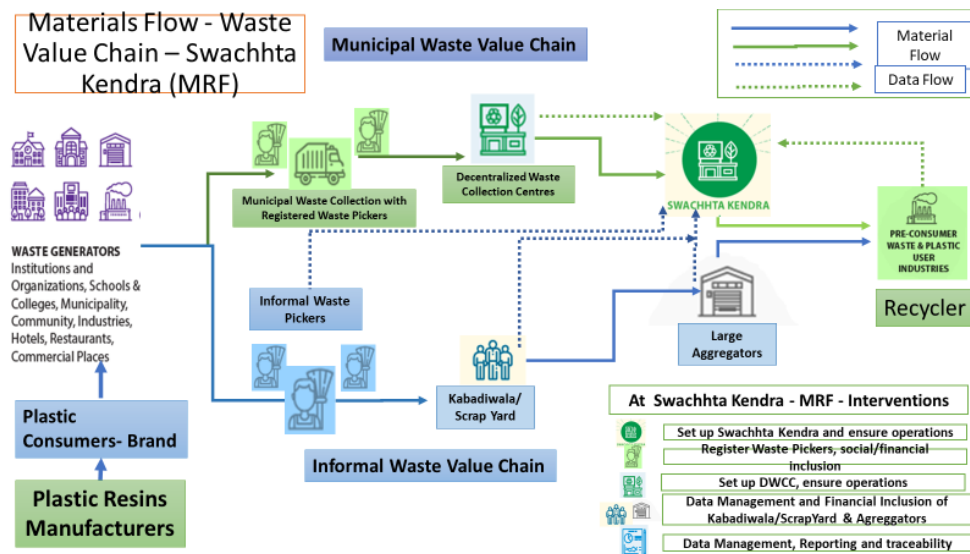

Figure 7: Material flows in the plastic waste value chain system

Yet, lack of integration of informal sector into the mainstream recycling industry leads to limiting their involvement to only certain fractions of waste. Furthermore, these workers are plagued with low wages and exposed to significant health risks.

2.3 Potential of Dry Waste in Circular Economy

The adoption of circular economy requires a shift in approach - a shift from linear – take-make-waste model to a full multi-life-cycle circular model. According to a KPMG study, the savings from circular economy in India are estimated at US\$ 624 billion in year 2050, for the current development trend¹⁵.

To move towards a circular economy in dry waste, **the design and material aspect related to production must be addressed**. Recycling is a crucial part of the circular economy, but the goal of “true recycling” is that of converting the waste resource back to its original form, without sacrificing quality or integrity in the process. The recycled material should be at par with what was originally created using virgin raw material, for true circularity.

¹⁵ Potential Economic Pay-off of a Circular Economy, 28th April, 2020

Material recycling facilities can play significant role in making dry waste management circular. If implemented, **material recycling facilities can help improve recovery from ₹5,187 crores/annum to ₹17,023 crores/annum by 2025 thus adding ₹11,836 crores to economy per annum.** MRFs will also help to generate **employment of 40 Lakh person-days** during construction of MRFs and **~80 Lakh person-days** in perpetuity for operations & maintenance of these facilities. Detailed calculations are enclosed in **Annexure 1.1.**

Contribution to Climate Change Mitigation

The waste sector (including dry waste) accounts for 3.7% of India's total national-level GHG emissions. Whilst the aggregate contribution may be insignificant when compared to sectors like land energy or land use change, waste sector emissions have risen at a compound annual growth rate (CAGR) of 4.2% during 2005-2015¹⁶. The GHG emissions per tonne of solid waste disposed have also increased by 2.7 times, rising from 85 kg of CO₂ per tonne of solid waste disposed during 1954-60 to 227 kg of CO₂ per tonne of solid waste disposed during 2005-2015. Hence scientific waste management can play an important role in mitigation of GHG emissions.

Applying circularity principles in dry waste management can help India achieve its GHG emissions reduction commitments faster. For example, if 'refill' bottle designs and models were to be applied to all bottles in cosmetics, personal care as well as home cleaning, packaging and transport savings would represent an 80–85% reduction in GHG emissions compared to today's traditional single-use bottles¹⁷.

2.4 Gaps in Policy, Regulations and Infrastructure

MoEF&CC have enacted several policies and regulations to implement the solid waste management roadmap, primarily through the Solid Waste Management (SWM) Rules, 2016, Plastic Waste Management (PWM) Rules, 2016 and 2018. Also, MoHUA has brought out comprehensive manual on solid waste management and various advisories for dry waste management:

- Plastic Waste Management Issues, Solutions & Case Studies
- Advisory on Material Recovery Facility (MRF) for Municipal Solid Waste
- Guidelines on usage of Refuse Derived Fuel in various industries

¹⁶ <https://www.youthkiawaaz.com/2019/11/what-a-waste-ghg-emissions-from-indias-waste-sector-and-what-can-be-done/>

¹⁷ Ellen McArthur Foundation, 2020

More recently, National Resource Efficiency Policy (NREP), 2019 was prepared to create a facilitative and regulatory environment to mainstream resource efficiency across all sectors. One of the guiding principles of NREP, 2019 is waste minimization.

Dry waste sub-committee assessed these and took into consideration various dry waste streams with the objectives of zero waste, zero burning, zero landfill and zero pollution to identify policy, regulations and infrastructure gaps:

Policy Gaps

While the current dry waste regulations seek to address the wastes' life cycles, that is from its generation to the end-of-life disposal, there are opportunities to leverage policy to accelerate the shift from waste management to an integrated circular economy. A circular economy approach entails creating incentives for businesses to innovate models that monetise their efforts in addressing the waste challenge. The existing policies need a relook to explore innovative mechanisms, especially on the following aspects:

- **No incentives to encourage recycled products/alternatives**
 - There are no incentives for industry to enter recycling business and/or research and develop upstream solutions/circular alternatives.
 - Currently the recycled products and alternatives fall under the same GST brackets as the products made from virgin materials thus there is no provision to encourage use of recycled products/alternatives.
- **Policy for Marine Plastic.** The growing marine plastic concern in India requires more focus yet currently there is no policy, rule or guideline which caters to marine plastic waste entering water bodies.
- **Policy for Mainstreaming of informal sector.** Even though informal sector plays significant role in making dry waste value chain resource efficient and circular, yet there is no policy mandating the mainstreaming of informal sector.
- **EPR limited to Plastic & Electronic Waste.** Currently EPR framework is limited to only plastic and electronic waste and yet to be fully effective. Lack of EPR framework for other dry waste streams such as Paper, Textile, Tyres/Rubber, Metal and Glass etc. leads to unscientific disposal of these waste streams while also losing valuable resources. Without EPR no circularity can be obtained.
- **Inadequate Labelling.** Inadequate labelling on products makes it difficult to segregate and categorize products. Products with low recyclability if mixed with

products with better recyclability can cause lesser recovery and sub-standard recycled products.

- **Inadequate consideration to life cycle impact and recyclability of materials.** Present EPR framework does not take into consideration the environment and life cycle impact of the products or recyclability of the materials used. Such a system does not discourage products such as multi-layered plastics and single-use plastics that are harmful to environment.
- **Landfilling of recyclables.** At present there is no provision mandating ban on disposal of recyclables in landfills. Disposing of recyclables in landfills/dumpsites not only leads to loss of valued resources but also causes environment pollution.

Regulatory Gaps

- **Complex EPR Framework.** Complexity of current EPR framework makes it challenging for manufactures to comply and authorities to monitor making the implementation of EPR framework difficult.
- **Lack of unified digital platform for EPR.** Currently there is no unified digital platform to capture end to end operational data and EPR compliance is manually done. Lack of unified digital platform leads to communication gap and processing delays.
- **EPR enforcement.** The EPR framework is not being enforced, setting a wrong precedent of non-compliance by the industry.
- **Compliance by Cement Industry.** Some waste processing facilities, generating RDF have not been able to find buyers due to high production cost. As per CERC notification in 2020, RDF was accorded a cost of ₹2084/MT¹⁸ to enable RDF plants to recover cost incurred on waste screening and processing cost. But this has not been widely accepted across cement companies. MoHUA has brought out an advisory on use of RDF in cement industry which indicates that the process is viable with payback period of 3-4 year only¹⁹.

Infrastructure Gaps

- **Limited innovative financing mechanism.** There are very few circular businesses, and these require financing support at various stages. Lack of

¹⁸ CERC Notification no. RS-14026(11)/4/2020-CERC, 28th April, 2020

¹⁹ Guidelines on usage of Refuse Derived Fuel in various industries, September 2018

identification of such businesses and extending financial support result in failure of such businesses creating a slip back.

- **No single-window clearance.** Recycling businesses require multiple clearances thus delaying the set-up while unorganized sector continue to run their businesses without any clearances.

2.5 Technology Options and Business Models

A judicious choice of technology is essential for resource recovery and processing and disposal of municipal solid waste. It is important to utilize the resources by employing a combination of technologies suitable for treating various components of dry waste. Below are some of the technologies for dry waste processing (details enclosed in **Annexure 1.2**):

- Material Recovery Facilities
- Mechanical Recycling
- Refuse-Derived Fuel (RDF) for Co-processing
- Plastic to Road Construction
- Pyrolysis
- Gasification
- Waste Incineration

Case Study – National: Indore Municipal Corporation’s Material Recovery Facility (MRF) Model (NEPRA Resource Management Pvt. Ltd)

NEPRA Resource Management Pvt. Ltd. is India’s leading dry waste management company that aims to solve several social and environmental challenges through the waste management sector and is working on PPP mode at various locations, including Indore Municipal Corporation (Madhya Pradesh). Its dry waste management achievements in the MRF since 2019 are given in figure 8 below. Such successful MRFs can be replicated in other Metro Cities.



Figure 8: Automated MRF at Indore

Business Models

There are five distinct types of circular business Models that can be adopted²⁰ in dry waste management:

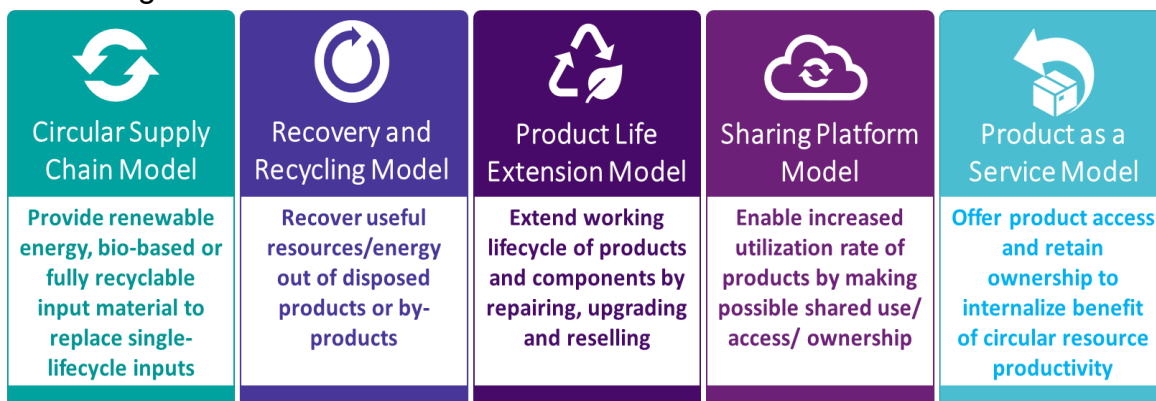

Figure 9: Five Business models for Circular economy²¹

For example, the five business models for circular economy in the plastic waste value chain (as in Figure 9) can help identify avenues for tackling plastic consumption or even create alternative markets while reducing the need for generating more plastic or producing plastic that has longer life, not aggravating the waste problem.

²⁰ Accelerating India's Circular Economy Shift. FICCI and Accenture Strategy 2018

²¹ Accelerating India's Circular Economy Shift. FICCI and Accenture Strategy 2018

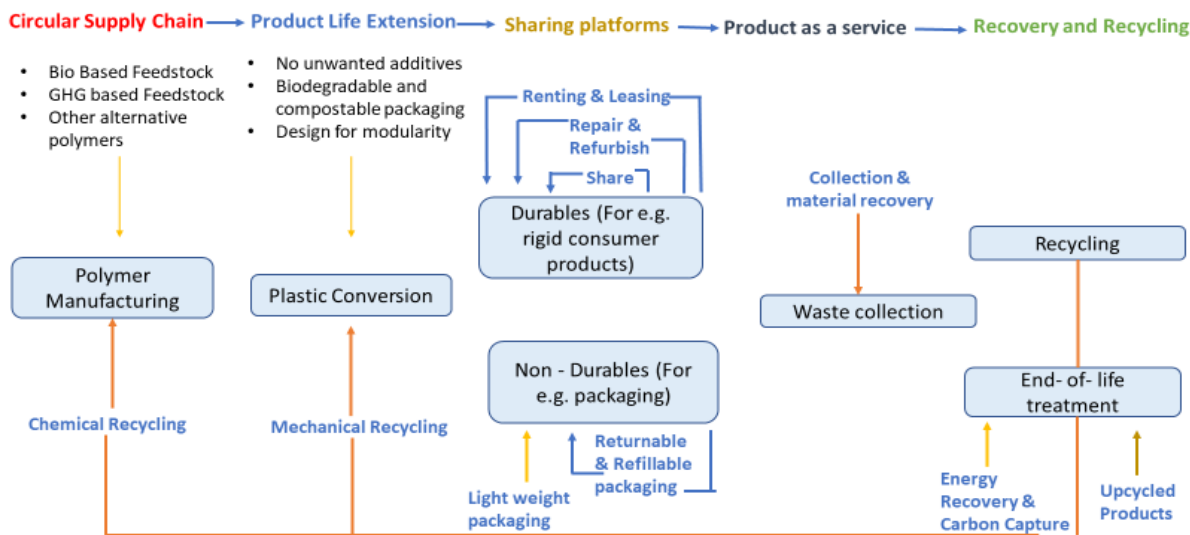

Figure 10: Circular Economy Business models in Plastics Value Chain²²

Digital Enablement

Besides the processing technologies, digital enablement can play a major role in transforming dry waste value chain making it more traceable, accountable, and digitally governed. Below are some of the digital solutions which can improve transparency, traceability and accountability:

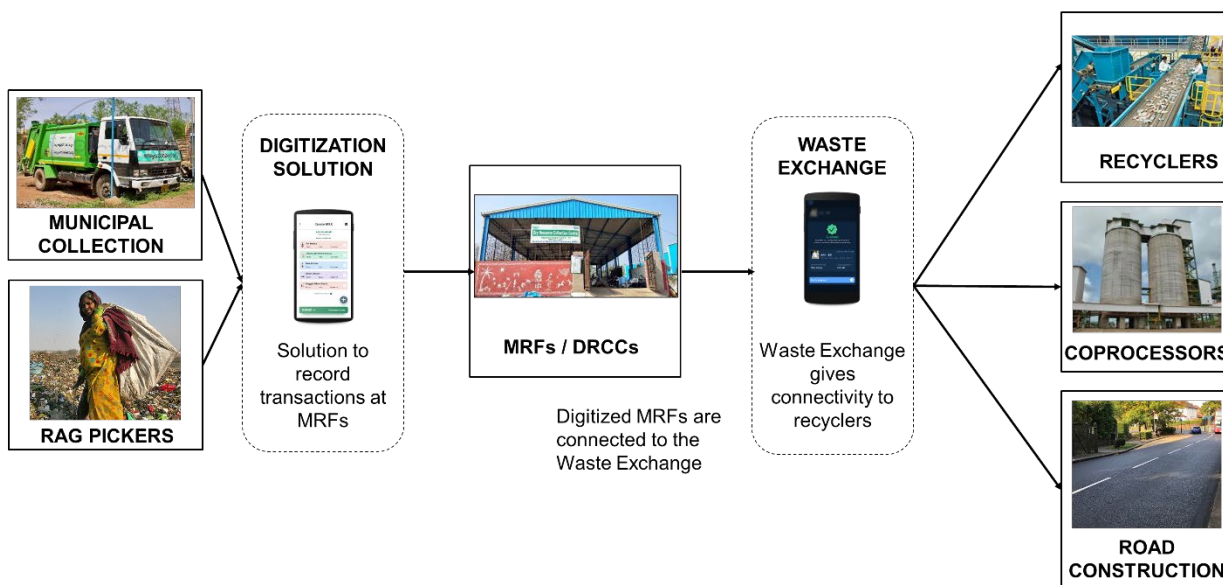

Figure 11: Digital Intervention in Waste Management

- **Digitization of waste pickers.** Waste collectors and waste pickers (Safai Mitras) are registered in the system and get their ID card suitably authenticated by the concerned Urban Local Body (ULB) and the implementing partner. This will help

²² Making Plastics Circular FICCI Accenture strategy 2019

in faster formalisation of informal waste-pickers through digitisation, providing them further access to various Government schemes.

- **Digitization of Waste Flow and Material Recovery Facilities.** Waste need to be tracked at every stage, from source to concerned waste collector and to material recovery centres. This can be enabled through the unique QR codes, GPS based tracking and role-based access control to ensure security and easy governance.
- **Digital Reporting system.** Reporting shall be stakeholders' wise i.e. EPR body, municipal bodies, implementation partners and operations team. Such reports help in analysing waste related data and plan suitable interventions.
- **Digital Waste Exchange.** App-based waste exchange platform that provides fair price market access to waste pickers, recyclers, companies to transact with each other at fair price.

2.6 Recommendations

It is essential to provide direction and monitor actions of each of the stakeholder's role in the dry waste value chain on a regular basis. In this regard, recommendations (listed below) have been identified in an action-oriented manner to improve circularity in dry waste management by having better material flow efficiencies, cost & material optimization and waste minimization while reducing adverse impacts on human health and environment.

Table 1: Recommendations for Dry waste

Policy Interventions		
Level	Stakeholders	Recommendations
National	MoEF&CC, MOHUA, CPCB, MoES, MoF, BIS	<ul style="list-style-type: none"> • Develop circular economy guidelines with circularity targets for each dry waste component • National policy for marine plastic • Policy for mainstreaming of informal workers, mandating their formalization • Policy for setting-up Waste Management Parks, Recycling zones • Make waste management as priority sector for lending and environmental clearances • Reduce GST to 5% for recycled products and alternate products • Expand EPR to include other dry-waste components: Paper, Textile, Rubber, Metals and Glass etc. • Funding for research & development of product re-design, remanufacturing and alternate materials

		<p>based on Life Cycle Assessment (LCA) and Material Flow Assessment (MFA)</p> <ul style="list-style-type: none"> • Technical guidelines for production, usage, and recycling of bioplastics. Mandate BIS marking
State/ ULBs	UDDs, SPCB, Industry Department	<ul style="list-style-type: none"> • By-laws and circular economy guidelines in line with national level guidelines • Introduction of landfill tax for dumping/disposal of any waste in landfill • Ban on disposal of recyclables in landfills • Focus on Zero Waste to Landfill approach through the Concessionaire/ RWAs/ WMAs • Regular circularity-based assessments at State level with ranking system

Regulatory Interventions		
Type	Stakeholders	Recommendations
National	MoEF&CC, CPCB	<ul style="list-style-type: none"> • Set up a standing task force to drive and monitor the circular economy initiatives across all dry waste components and value-chain • Digital platform to capture end to end dry waste material flow data for transparency and traceability • Mandating use of 25% recycled materials in the non-food grade packaging to ensure uptake of recycled materials. • Mandate for cement kilns to use 25% RDF (non-recyclable combustible dry waste) replacing coal • Mandate use of mono-polymers in the production of the packaging products. e.g., PET bottles with HDPE cover/cap and PPP films avoided, to enhance recycling
State/ ULBs	UDDs, SPCB	<ul style="list-style-type: none"> • Mechanism to monitor dry waste processing and rejects at the ULB level to reduce landfilling • Mandate and enforce segregation, informal sector inclusivity and capacity building initiatives through inclusion in contracts • Enforcement of penalties in case of non-compliance

Infrastructure Interventions		
Level	Stakeholders	Recommendations
National	MoEF&CC, DPIIT, MoF	<ul style="list-style-type: none"> • Mechanism for single window clearance • Simplify registration and compliance processes for recyclers and waste management agencies • Incentives to use RDF in cement kilns to save coal as a resource and penalties for not using RDF • Land allocation to set-up Waste Management Parks, Recycling zones • Innovative financing mechanism to support recycling infrastructure: <ul style="list-style-type: none"> • Setting up of a Credit Guarantee Fund. • Funding to waste management related start-ups
State/ ULBs	UDDs, SPCB, Industry Department	<ul style="list-style-type: none"> • Separate collection systems for SUPs, MLPs etc. • Set up Material Recovery Facilities, connected to recycling and upcycling facilities • ULB level dashboards for digitally capturing dry waste collection and management records • Tie-ups with manufacturers under EPR and cement kilns or waste to energy plants for RDF use

Chapter 3: Report of Sub-Committee on Wet waste



3.1 Introduction

Municipal Solid Waste (MSW) in India primarily consists of biodegradable (wet), non-biodegradable (recyclable and non-recyclable - dry), sanitary/ domestic hazardous waste and inert fractions. Its typical composition is shown in figure 12 below.

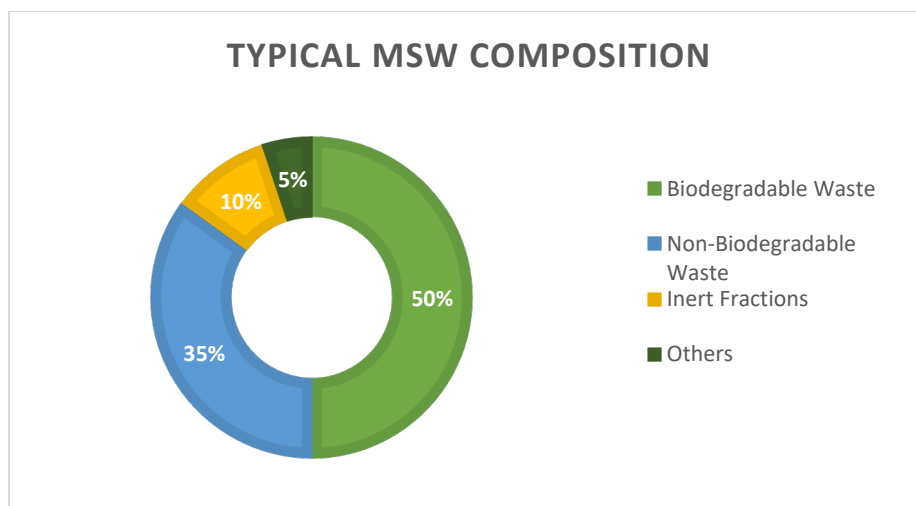

Figure 12: Graphical representation of MSW Composition

***Wet waste**, also known as organic waste or biodegradable waste includes kitchen waste, market wastes (vegetables, meat, fruits and flowers), horticultural wastes and such similar waste. As shown above, it is 50% of MSW.*

Wet Waste characteristics

Wet waste is highly biodegradable matter and starts to decompose immediately upon disposal. During degradation, microorganisms break down complex substances into simple organic matter. A number of factors influence the degradation such as moisture, temperature, availability of air/oxygen, sunlight and micro-organisms etc.

If the wet waste is not treated properly and dumped in landfills, it can become a major source of greenhouse gas (GHG) emissions and leaching of harmful substances causing air, water and soil pollution. Therefore, the scientific handling and treatment of wet wastes involves proper segregation; putting it through controlled processing as early as possible; and ensuring it is not dumped.

The scientific biological methods used in its processing are composting and biomethanation, which are basically aerobic and anaerobic processes respectively. The processes and downstream applications can be seen in figure 13 below:

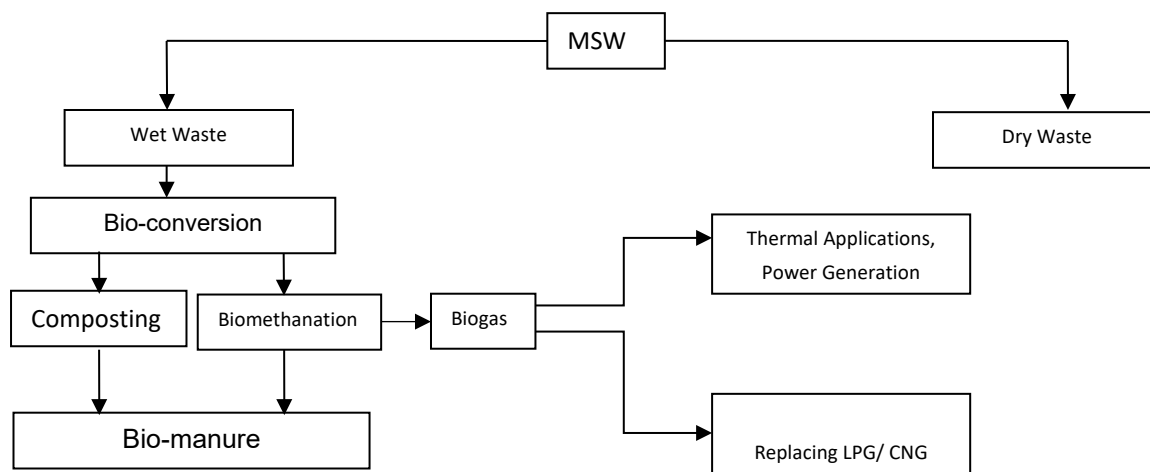

Figure 13: Wet waste processing through Bio-methanation

Urban India was historically lacking in scientific processing of waste. But the Swachh Bharat Mission initiated by the Prime Minister in 2014 has rapidly changed the situation by giving impetus to Swachhta / cleanliness. Waste processing which was only 18% in 2014 has gone up to 68% in 2021 and will continue to improve with renewed focus under SBM (U) 2.0.

Globally, the waste processing was accorded high priority. The initiatives take by European Union (EU) offer solution to deal with increasing waste quantities.

International best practices

The European Union has issued directives to the member countries for improving waste management as given below:

- The Waste Framework Directive (2008/98/EC): The Waste Framework Directive is the EU’s legal framework for treating and managing waste in the order of preference called the “waste hierarchy”, in which reuse/ recycling are of high priority whereas the traditional landfilling is given least priority.
- The Landfilling Directive (1999/31/EC): The Landfill Directive aims to prevent or reduce any negative impact from landfill on surface water, groundwater, soil, air and human health.

In order to promote circularity, the revised Waste Framework Directive (WFD) (EU, 2008, 2018b, 2018/850) introduced several changes relevant for bio-waste (wet waste), dry waste and landfills:

- All EU Member Countries to collect bio-waste separately or ensure recycling at source as other waste management directives are unlikely to be met without proper management of bio-waste;
- an aspirational target to reduce food waste in line with SDG 12.3
- By 2030, waste of any kind suitable for recycling or other recovery contained in municipal waste, will not be permitted at landfills.
- By 2035, the amount of MSW disposed of in landfills is reduced to 10% or less of the total MSW.

Among Asian countries, Japan, Singapore and South Korea have taken up scientific MSWM aggressively and national goals, in the spirit of circularity.

In India, the SWM Rules 2016 are on similar lines of waste management policies of EU being enabled under SBM(U) components of scientific MSWM; shared responsibilities for MSWM by private citizens and public authorities, capacity building, innovations for techno-commercial viability and the introduction of healthy competition among ULBs on cleanliness.

There is still vast scope for improved MSWM in our country not only in achieving scientific processing, but also by introducing efficient resource recovery and recycling through circular economy principles to become net provider (mine) of input materials to the growing economy.

In the subsequent sections, the potential of circularity in wet waste processing along with gaps identified and recommended actions thereof are described.

3.2 Current Scenario and Challenges

About 75,000 TPD of wet waste is being generated daily, which continues to grow with population and changing lifestyles. Under SBM (U), about 68% is being processed, leaving a gap of 32%. Projections for SBM (U) 2.0 indicate a requirement of 45,000 TPD processing facilities for wet waste, out of which the compost plants are planned for 30,800 TPD and bio-methanation plants for 15,200 TPD.

Current Policy Initiatives

In order to encourage scientific processing of wet waste, Government of India has introduced various policy interventions such as:

- Market Development Assistance** of ₹1,500 per tonne on city compost by M/o Chemicals & Fertilizers to scale up compost production and consumption. For this, compost processing plants have been tagged with fertilizer distribution companies in all States.
- MNRE is providing financial assistance for setting up of Waste to Energy Plants as follows:

- a. For biogas, capital subsidy of ₹1 crore per 12000m³ biogas/day is provided. [up to Rs.10 crore/project]
- b. Under power projects, subsidy of ₹3 crore per MW is provided. [up to ₹10 crore/project]. For existing biogas units switching to power generation, the subsidy is ₹2 crore per MW.
- c. For bio-CNG/ enriched biogas (CBG), subsidy of ₹4 crore for 4800kgs/day of CBG generated per day [up to ₹10 crore/project]. For existing biogas units switching to CBG, the subsidy is only ₹3 crore.

Regulatory Initiatives - SWM Rules 2016

SWM Rules 2016 comprehensively cover all aspects of municipal solid waste management, with strong emphasis on segregation, followed by segregated waste processing. Recycling and recovery have also been embedded into rules. Hence the SWM Rules can become the springboard to launch circular economy principles in MSWM.

3.3 Challenges in Wet Waste Management

- Poor segregation of waste at source reduces the efficiency of the processing facility.
- Inadequate infrastructure to transport segregated wet waste to processing facilities
- Non-Compliance of SWM Rules 2016 by the Bulk waste generators
- Data on waste generation in terms of composition and quantities is still lacking with cities. This leads to difficulty in designing waste processing facilities.
- Models of collection, transportation, processing for wet waste processing lack financial feasibility.
- Production of compost from mixed waste leads to quality challenges in final product.
- Insufficient numbers of testing labs, and monitoring protocols for compost
- Lack of logistic supply chain for distribution of compost in rural areas
- SWM Rules 2016 lack provisions for testing of Compost (methodology, frequency of testing etc).
- Inadequate awareness regarding compost policy and Market Development Assistance (MDA) released by GOI among ULBs and compost producers.

3.4 Potential of Wet Waste Management in Circular Economy

Wet waste generation will continue to grow along with population and may accelerate with changing lifestyles of eating out and food deliveries. The traditional composting of wet waste, even after MDA intervention under the SBM is still not generating adequate returns to ULBs. With the stabilization of segregation, wet waste processing should use the more

beneficial bio-methanation process. According to Center for Analysis and Dissemination of Demonstrated Energy Technologies CADDET, aerobic composting is a net energy user (261 MJ/tonne) while anaerobic digestion is net energy generator (366 MJ/tonne).

Existing Compost plants may continue to be operated. The shortage in wet processing capacity, as it arises, may be fulfilled only by Bio-methanation plants, as well as the replacement of old, defunct compost plants. The comparison of economic benefits of composting vis-à-vis bio-methanation is given below.

**Table 2: Indicative Economic Benefit for 50TPD Wet Waste Processing
(for a population equivalent of 2.50 Lakh)**

Process	Outputs	Yield per 100 Tonne	Rate / MT	Revenue	O&M costs	NET Economic benefit. Rs.
Windrow Composting	Compost	7.50 TPD	₹2,500	₹18,750	₹10,000 @ ₹1,330/ Tonne	₹ 8,750
Biomethanation	Biogas (3%)	1.50 TPD	₹46,000 (SATAT)	₹69,000	₹30,000	₹ 51,500
	Compost from Dried Slurry (10%)	5 TPD	₹2,500*	₹12,500	@ ₹20,000/ Tonne of Gas	
	Total			₹81,500		
Extra benefits of Biomethanation over traditional composting for 50 TPD plant, considered as techno-commercially viable. *Considering same rate as compost						₹ 42,750

Bio-methanation can be significantly more profitable than traditional composting as shown in table above.

Applying the circular economy model, wet waste processing through bio-methanation can yield the additional benefits, as follows by 2025 (Annexure 2.1)

1. Net additional contribution to economy of ₹2,460 crores per annum if 50% wet waste is processed by bio-methanation in urban India.
2. Employment generation of about 1 crore man-days during construction and about 0.60 crore man-days for O&M, in perpetuity.
3. Reduction in GHG emissions by about 10.36 million tonnes CO₂ equivalent

Plant capacities lower than 50 TPD for biomethanation are not recommended. For such smaller capacities, composting is the preferred option due to its robust and simple technology.

3.5 Technology Options and Business Viability Models

For wet waste processing, mainly two technologies are being used, namely, (1) Biomethanation and (2) Composting. Same are briefly described below.

(1) Biomethanation

Bio-methanation technology and its business viability has been proved by several Government Institutions and Private Entrepreneurs.

Bhabha Atomic Research Centre (BARC), Mumbai has developed the Nisarguna technology for decentralized wet waste processing plants. Several such plants are operating successfully.

The CSIR- IICT at Hyderabad has conducted several pilots of improvised bio-methanation plants of different scales, using segregated wet waste. One of the plants set up with CSIR-IICT partnership at Bowenpally market near Hyderabad got a positive mention from the Prime Minister during the *Mann ki Baat* program.

Private sector developers have set up successful plants at Indore. Looking at the success, Government of Madhya Pradesh is setting up large scale wet waste-based bio-methanation plants at Bhopal and Indore.

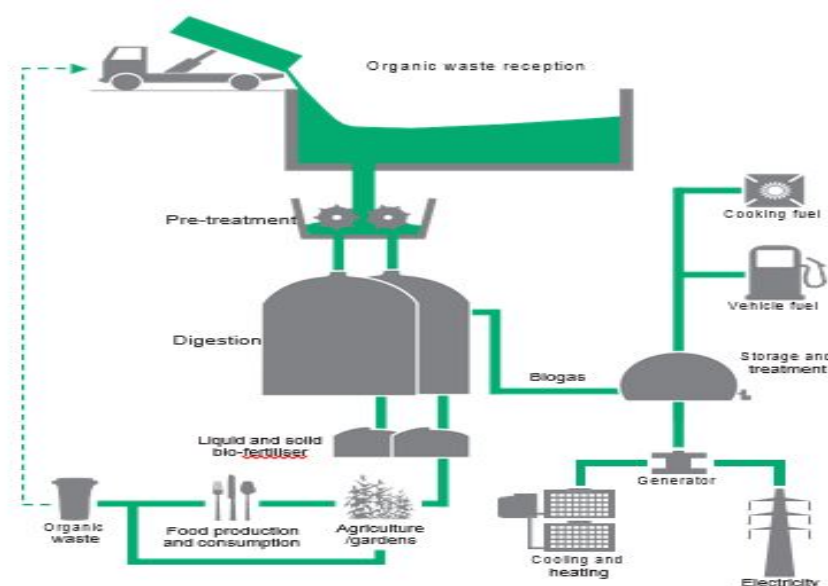

Figure 14: Typical Circularity in Biomethanation Process Flow

Challenges in Promoting Bio-methanation Plants

- Allocation of encumbrance free land
- Uninterrupted supply of segregated wet waste
- Coordination with many Government agencies

- No long term buy back arrangement by OMCs and FMCs for biogas and compost
- Financing as there is no priority lending
- Handholding of developers by ULBs. Timely disbursements.
- Specialized O&M requiring industrial standards, private developer-operators are essential

Benefits of Bio-methanation

- Less land requirement compared to composting.
- Closed process, no odor, dust and leachate issues; no rain interruptions.
- Shorter process and lower vulnerability to climatic conditions.
- Production of green fuel like Biogas/ Bio-CNG.
- Supplements National actions on GHG reductions

(2) Composting

Composting of wet waste is a process using microorganisms for degrading the waste to produce compost. It is robust and well-established technology requiring simple O&M that can be provided by semi-skilled personnel. Composting presents problems of high land requirement for higher quantities of waste. The types and scale of composting process are given below (from USEPA):

Table 3: Types and scale of composting process

Type of Composting	Scale	Concerns	Resources required
On-site Composting Composting on premises using either a bin or a pit in the soil	Very Small	Odour control and vermin	Either a pit or bin
Vermicomposting Composting in bins where worms process organic materials	Small	Sensitive to temperature changes	Worm bins, worms
Aerated Windrow Composting Composting outside with organic materials structured in rows and regularly turned/aerated	Large	Siting requirements, zoning, regulatory enforcement (i.e., leachate, odour)	Land, equipment, continual supply of labour
Aerated Static Pile Composting Composting with static piles of organic materials that are aerated internally with blowers	Large	Siting requirements, zoning, regulatory enforcement (i.e., contaminant runoff), odour	Land, large financial resources, equipment including blowers, pipes, sensors and fans

Challenges in composting

- Large land requirement; Siting Problems; Odour and Vector problems

- Low level O&M efforts but any slack in O&M generates GHGs
- Longer duration process. Requires minimum 6 weeks, followed by maturation period 2 weeks.
- Seasonal Challenges – both in production and in sales. Requires large warehouse facilities. Monsoon sheds required are costly for large areas.
- Low uptake in market due to complicated MDA and quality certification.
- Problem of micro plastics even after screening requires high segregation, similar to biomethanation

Benefits of composting

- Simple method adaptable to any ULB, provided adequate land is available.
- Low in CAPEX and OPEX, on tonne-to-tonne basis.

3.6 Recommendations and Action Plans

Based on the situation analysis of current wet waste processing, the potential economic benefits etc., as given in the previous pages, the gaps in the existing regulatory framework and policy are identified. Actionable points as recommendations against identified gaps are given below, duly categorized as National level, State/ UT level and ULB level, along with the relevant stakeholders, and further categorized as: a) regulations, and b) enablers.

Table 4: Recommendations and Action Plans for Wet waste circularity

S.No	Actionable Points	Stakeholders	Responsibilities
National Level Regulations			
1	Segregated MSW Rules for Wet & Dry wastes and for SLFs	MoEF&CC, MoHUA, MoJS	MoHUA and MoJS to prepare the segregated MSW Rules MoEF&CC to notify
2	Unbundling SLF from SWM functions	MoEF&CC, MoHUA, MoJS, States	MoEF&CC to make Sanitary Landfill (SLF) a separate waste management facility outside ULB/ UDD domain, operating on landfill fee model.
3	To relax environmental clearance (EC) for the waste processing plants	MoEF&CC, MoHUA, MoJS, States	MoEF&CC to recognise waste processing plants in GREEN category
4	Amendment in FCO 1985	Mo Agriculture & Farmers Welfare	MoAgFW to workout required amendments in FCO 1985 to include compost from biomethanation; and to set up testing labs in all districts

5	Tax holiday for waste processing plants for 5-10 years	MoF MoEF&CC MoHUA MoJS	Ministry of Finance to notify. MoEF&CC, MoHUA and MoJS to provide inputs
6	Waste processing plants listed in priority lending sector	MoF	Ministry of Finance to notify. MoEF&CC, MoHUA and MoJS to provide inputs
7	Defining Business Rules for biomethanation from MSW	Cabinet Sectt., MoF, MoHUA, MoJS, MNRE	Cabinet Secretariat to clarify as MNRE is claiming sole domain which can be detrimental to integrated SWM
8	Centre of Excellence	Research Institutes, Universities	One premier technical institute and agricultural institute maybe recognized as centre of excellence

National Level Enablers

1	Convergence with stakeholder Ministries	MoHUA, MoJS, MoPNG, MoP	For convergent actions promoting biomethanation, a High Power Committee under chairmanship of secretary/ Additional Secretary may be set up
2	Customs and GST exemptions	MoF	MoF to exempt customs on imports for biomethanation plants and provide GST relief
3	Incentivizing biogas plants	MoPNG	MoPNG to incentivize biomethanation plants; buy out biogas up to 1 tonne/ day instead of 2 tonnes/ day)
4	Incentivize by-products and tag sale with chemical fertilizers	Ministry of Chemicals & Fertilizers	MoCF to extend MDA for city compost to compost produced out of biomethanation and tag sale of compost with chemical fertilizers
5	Inventorization of biomethanation plants by SPCBs/ PCCs / CPCB	MoEF&CC	To evaluate performance and to run the plants efficiently & refurbish where necessary

State Level Enablers for infrastructure

1	State Policy & Strategy on biomethanation and biogas	States	States to set the way forward for biogas economy by drawing up a policy and strategy for implementation
2	State incentives to biomethanation plants	States	States to provide incentives to private developers to invest in the biogas economy

3	Developing clusters for waste processing	States	States to develop district level Waste Processing Parks, under the District Collector for enabling LBs to meet statutory requirements
4	Strengthening segregation at collection level	States and ULBs	Empower safai karamcharis to levy fines/penalty on unsegregated waste and to refuse collection
5	Tax/fine on dumping wet waste in landfills/ open land	SUDD SPCB	SPCB to impose heavy fines/Taxes on indiscriminate dumping of wet waste
6	Designating Nodal Department	SUDD, Agriculture Deptt., SPCB	A suitable State department may be designated as nodal department to coordinate with other departments through a high-level committee for required infrastructural and policy needs.
7	Compost Testing facilities and Labs	SPCB, SUDD	State Agriculture department/UD department set up compost testing facilities

Social Interventions

1	School Curriculum on Waste Management	States/ CBSE	To inculcate good citizen behavior in waste management, it should be made part of curriculum throughout school.
2	Capacity building & dissemination of best practices	SUDD	Suitable capacity building and training of personnel engaged in MSWM at State/ULB level. National and international successful models need to be disseminated to ULBs
3	Awareness creation	SUDD	Effective strategy for awareness creation on reuse of by-products out of wet waste processing to public

Case Study-1: Biogas replacing CNG for Automobiles

BioCNG Plant for segregated organic MSW generating automobile Gas

The bio-CNG plant on bio-methanation process generates biogas and digestate as products. The biogas is cleaned and enriched to remove hydrogen sulphide, water, particles and CO₂ present in the gas, giving methane suitable as fuel for automobiles. The model has been successful in a 20 TPD plant at Indore set up and operated by Mahindra Ecosystems. Besides the bio-CNG, organic fertilizer is also produced which attracts higher selling price than traditional compost. There is near zero discharge from the plant. Details are given in Annexure-2.2.

After this success, Indore set up another 15 TPD plant successfully. And in 2020, Govt. of Madhya Pradesh launched a project for 550TPD in two stages (250 + 300 TPD), the contractor being ILFS & a German firm.



Figure 15: A view of 20 TPD Bio-methanation Plant at Indore

Case Study-2: Biogas replacing LPG for cooking

CSIR-IICT Economic Model for quantification of cost benefit analysis

A decentralized high rate bio-methanation system could replace LPG with biogas for cooking in community kitchens or similar setups. Approximate capital & operating cost and return on investment are tabulated and shown in table at Annexure-2.3. For process capacity of 10,000 kg/day, the payback period is 2.2 years using commercial LPG rates.



Figure 16: High Rate Biomethanation Plant at Toranagallu (Bellary), Karnataka

International Case Studies

SWEDEN

NSR Biogas Plant at Helsingborg –Sweden

The NSR biogas plant in Helsingborg (1996) is a regional waste recycling company owned by six local authorities in north-west Skåne (Bjuv, Båstad, Helsingborg, Höganäs, Åstorp and Ängelholm) for treating various organic wastes. Nowadays, the refinement of biogas vehicle fuel is an additional motivation. Upgrading of biogas started in 1997, and capacity doubled by 2007. Another product 'NSR Bio-manure' started marketing bio-manure to agriculture and its quality is nowadays recognized under the certification system.

Food waste is the primary substrate digested in the reactors with pre-treatment process also. The substrate consists of process waste from the food industry, fresh pig manure and source-sorted food wastes. The plant is designed to accept up to 80,000 tons per year (220 TPD). The plant produces 23,000 MWh of raw biogas, upgraded to vehicle fuel quality. Some of this gas is sold in NSR's public filling stations and is also used to run refuse lorries. Most biogas is distributed through the gas grid and is used to run buses. Propane is added to this gas to give it the same energy content as natural gas. In total, the biogas produced by NSR runs 100 buses, 20 refuse lorries and a large number of cars both locally and regionally. The biogas produced replaced more than 1.3 million litres of petrol and thereby reduced carbon dioxide emissions by 2800 tons.

CANADA

These are Anaerobic Digestion (AD) plants digesting food waste as the primary feedstock in Canada, including the City of Toronto's 2 AD plants (total capacity 130,000 tonnes year-1 i.e., 178 TPD each), five municipal food waste AD plants for Quebec municipalities and three private commercial plants in Ontario. In Ontario there are currently 4 facilities with permitted capacity over 80,000 tonnes per year (55 TPD each) licensed to process domestic food waste. These plants are also co-digesting agricultural manure or sewage sludge. A number of provinces are pursuing policies to support Renewable Natural Gas (RNG) – methane derived from renewable sources including biogas from such AD plants and delivered via the existing gas grid. There are approximately 12 RNG plants currently operating in Canada, many of which are processing some percentage of food waste.

Chapter 4:

Report of Sub-Committee on Construction & Demolition waste



4.1 Introduction

Construction and Demolition waste comprises of building materials, debris and rubbles generated during construction, re-modelling, and demolition of structures. On segregation C&D waste can be categorized into concrete, soil, steel, wood and plastics, bricks and mortar and other salvaged building components.

Estimates suggest that the average generation of C&D waste in India works out to approximately 12 million tonnes per year. The constituents of C&D waste generated, and their quantities vary across cities due to different types of construction practices. Approximately 95% of C&D waste can be reused or recycled if processed scientifically. However, owing to current lack of infrastructure for processing C&D waste, most of the C&D waste are sent to landfills or get mixed with MSW, further adding to processing challenges of MSW.

Globally, C&D waste is beneficially recycled to the tune of 50% in EU. Some of the countries like UK (90%), US (70%) & France (48%) are leading C&D waste processing and recycling in the true spirit of circular economy.

India possess huge potential in recycling and reusing processed C&D waste as it can be a substitute to virgin construction materials which are in high demand in the country. Realizing this opportunity, NITI Aayog together with relevant ministries are encouraging maximum recycle and reuse of C&D waste.

This chapter focuses on the preparation of a practically implementable and dynamic action plan for management of C&D waste in India. It is based on identified challenges and roadblocks in the current scenario of C&D waste management. The various sections of this chapter:

- Provides an overview of the regulatory framework and policies that promote a transition to the circular economy and management of C&D waste
- Analyzes the existing scenario of C&D waste management in India and identifies challenges and roadblocks in this sector
- Scopes out specific areas of intervention and priority action areas in the sector
- Assesses some best practices and lessons learnt on strengthening the C&D waste management system from cities or models in India
- Makes recommendations for strengthening the waste management system based on circular economy principles.

Integration of Circular Economy concept in C&D Waste Management

The waste management sector will have to become a crucial partner in new business models that focus on waste prevention and ‘turn waste into resources’. Circular product design will require feedback from the waste management sector on how products or components could be remanufactured, dismantled, and recycled. Instead of viewing waste as a threat, the waste management sector, in close cooperation with industry, will have to produce high-quality secondary raw materials that can be fed back into production processes.

A linear model of consumption is no longer sustainable as limited resources cannot meet our endless demand. The environmental benefits of avoiding waste far outweigh the environmental impacts of any other waste management options lower down on the waste hierarchy.

The principle of *reducing waste, reusing, and recycling resources* and products is often called the "3Rs". Waste management systems often rely on the ‘3R principle’ to conserve resources. The application of 3R concept in the context of C&D waste management is shown in figure below:

3R IN CONSTRUCTION AND DEMOLITION WASTE MANAGEMENT		
REDUCE	REUSE	RECYCLE
Regulating/ Standardizing management plan of materials	Promoting Reuse of waste materials thus reducing dependency on virgin materials	Harvesting materials at construction or demolition site
Identifying & quantifying amounts of C&D waste and treatment needs	Production of high-quality recycled aggregate	Recycling waste wood, metal, plastic, gypsum, and other waste materials
Specifying actions for every type of waste	Using same material for same application	Driving innovative recycling opportunities
Defining Responsibilities	Reuse of wood and Steel elements	Promoting & creating markets for recycled products
Establishing on-site waste sorting practices	Applying innovative storage and handling practices for reuse	Minimizing cost for recycling processes
Monitoring waste generation establishing waste separation and collection strategies	Reuse of sanitary and electrical fittings	Establishing management plan and SOPs; Applying innovative storage and handling practices

Figure 17: 3R strategies for Construction & Demolition Waste

Complete circularity in C&D waste management can only be achieved when a sustainable and comprehensive strategy and action plan is prepared and implemented throughout the lifecycle of construction projects, viz.

- Planning phase (during appraisal of the project and preconstruction activities)
- Construction Phase (during construction)
- Operation, Repair and Maintenance Phase (during the lifespan of a structure)
- Dismantling phase (at the end of the service life of a project for recycling and reuse of demolition waste)
- Collection, processing, and recycling of C&D waste.
- Production of recycled products and use of recycled material for further construction activities

4.2 Current Scenario and Challenges in C&D Waste Management

In India, the average generation of C&D waste is about 12 million tonnes per year i.e. 20-25% of total MSW generation in country. Large scale construction projects of housing, industry & infrastructure development are under implementation across the country. Development of economic zones, industrial corridors, redevelopment & rehabilitation works, besides repairs & renovation contributes to the magnitude of C&D waste.

Suitable laws are being formulated by the authorities, but enforcement of such laws has its limitations. Private contractors remove this waste to privately owned lands, low-lying areas for a price, or more commonly, dump it in an unauthorized manner along roads or other public areas. C&D waste from individual households finds its way into nearby waste bins making the municipal waste heavy and degrading its quality for treatments such as composting or energy recovery. The activities regarding C&D waste management, processing and re-use have been energized after issuance of C&D Waste Management Rules, 2016 by the Ministry of Environment, Forests and Climate Change (MoEF&CC).

General Composition of C&D Waste

The constituents of C&D waste generated, and their quantities varies from city-to-city and even regionally due to different types of construction practices. The representative C&D waste in urban areas consists of soil, sand and gravel (47%), bricks & masonry (32%), Concrete (7%), metal (6%), wood (3%) others (5%) as shown in figure 18. Bricks, tiles, wood and metals are sold for reuse/ recycling. The remaining materials are generally sent to landfills.

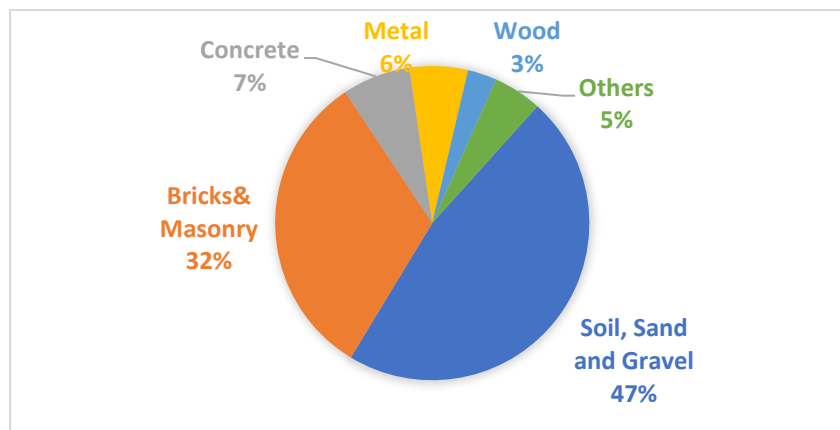

Figure 18: Composition of C&D Waste in India²³

C&D Waste Management in Indian context:

Under the Swachh Bharat Mission (Urban), it is assumed that C&D Waste varies from 5-25% of the MSW generated in various ULBs depending upon their economic and developmental scenario. Table 5 shows assumptions of C&D waste generation in different population categories of cities.

²³ Utilization of Recycled Produce of Construction & Demolition Waste - Building Materials & Technology Promotion Council, Ministry of Housing & Urban Affairs

Table 5: C&D waste generation with respect to population categories*

Sr No	Population Categories	C&D waste Generation
1.	More than 10 million	Approximately 25% of the Total solid waste generated
2.	1-10 million	20-25% of the Total solid waste generated
3.	0.5- 1 million	15-20% of the Total solid waste generated
4.	Less than 0.5 million	10% of the Total solid waste generated
*Assumptions based on current trends of C&D waste generation		

The amount and character of C&D waste generated is influenced by several factors such as population, rate of urbanization, population density and socio-economic conditions.

In most of the ULBs where proper management of C&D waste is not established, it mixes with municipal solid waste which results in increased processing cost and reduced efficiency.

Classification of Processed C&D Waste

C&D Waste in India are classified into two different types as shown in figure 19:

- Recycled Aggregates (RA)
- Recycled Concrete Aggregates (RCA)

RA consists of waste from brick masonry, cement mortar, tiles etc. On the other hand, Recycled Concrete Aggregates (RCA) are produced by crushing of concrete rubble, screening, & removal of contaminants. RCA contains aggregates as well as hydrated cement paste that adheres to its surface. Out of total C&D waste generation, about 90-92% is RA and 8-10% is RCA.



Figure 19: Types of C&D waste

Global Scenario

An overview of country wise status of C&D waste generation along with recovery rate as per the latest literature available is given in Figure 20

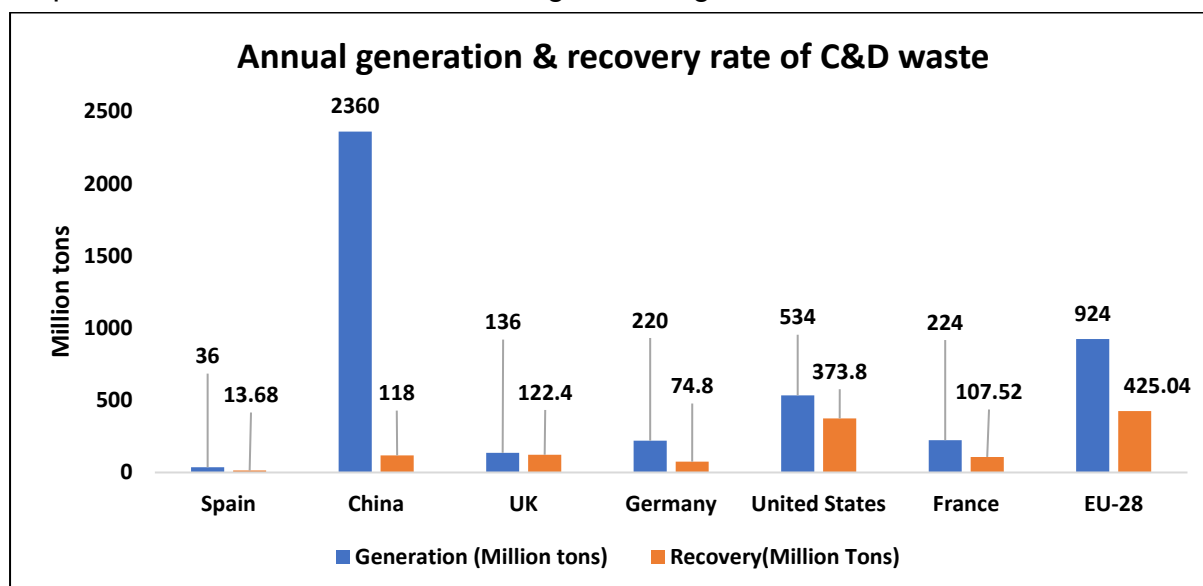

Figure 20: Annual generation & recovery rate of C&D waste in some countries²⁴

Benefits of implementation of C&D waste management

Potential benefits of implementation of C&D waste management are given in the below table 6.

Table 6: Benefits of C&D Waste Management

Economic and social benefits	<ul style="list-style-type: none"> • Scientific C&D waste management prevents mixing of C&D waste into MSW stream thus reduces processing cost and increases efficiency of MSW. • C&D waste management prevents clogging of drains and water bodies therefore avert flooding in urban areas • Proper management and recycling of C&D waste leads to saving of precious land by reduction in volume of inert going to landfill • C&D waste processing and recycling generates employment through new enterprises. • Use of C&D recycled products help in reducing the demand and requirement of virgin material and natural resources
Environmental benefits	<ul style="list-style-type: none"> • Scientific C&D waste management suppresses dust generation. Thus, significantly reduces air pollution.

²⁴ Luis Alberto Lopez Ruiz et al., Journal of Cleaner Production 248 (2020)

- Prevention of unauthorized dumping of C&D waste in drains and hydrological channels reduces chances of flooding
- Utilization of recycled products from processed C&D waste helps in reducing environmental impacts of mining

Challenges of C&D Waste Management

The challenges of C&D waste management can be broadly classified into the following four types as shown in figure below

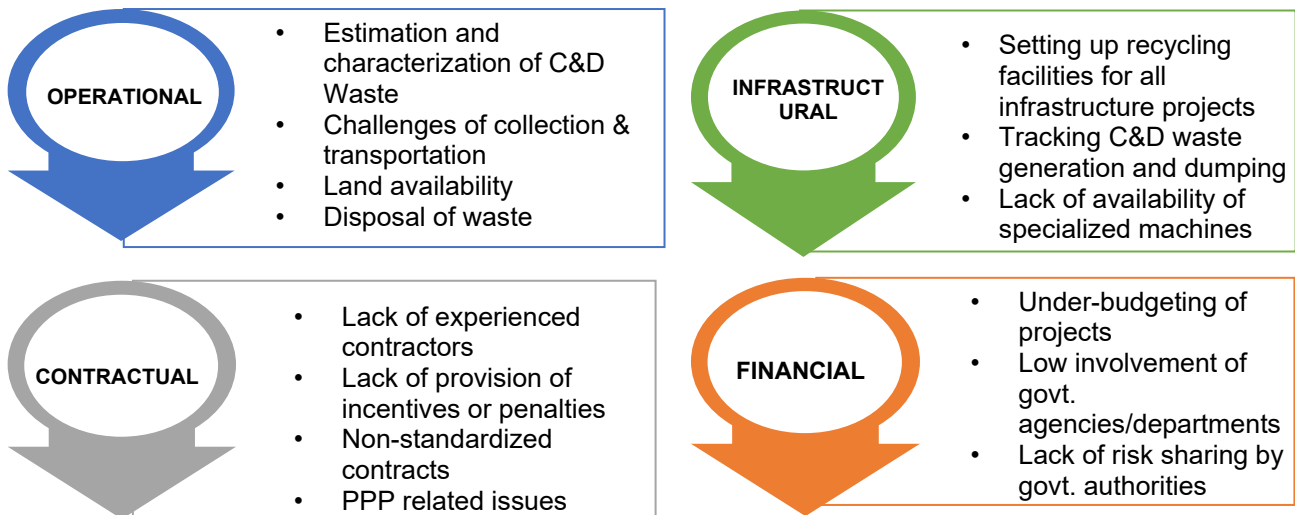

Figure 21: Challenges of C&D Waste Management

4.3 Circularity & Potential of C&D Waste

Circular Economy (CE) is promoted by material reuse either by direct use or by repair/refurbishment that ensures use of C&D Waste within the construction industry. Interventions for promoting reuse are already established as mentioned below and shown in Figure 23 :

1. Adaptive reuse—It is a method that reuses whole or part of a structure that is redundant.
2. Deconstruction—It is the careful dismantling to maximize the recovery of components to be reused.
3. Design for deconstruction (DfD)—It is a designing method that enables quality and quantity of materials that can be re-used at the end of a building's life
4. Design for reuse (DfR)—It incorporates the use of reclaimed components in the design of new structures.
5. Design for longevity (DfL)- It is a principle that current buildings in planning phase should be planned for long-term use. The construction material should be of top quality which could enhance the life of the building.

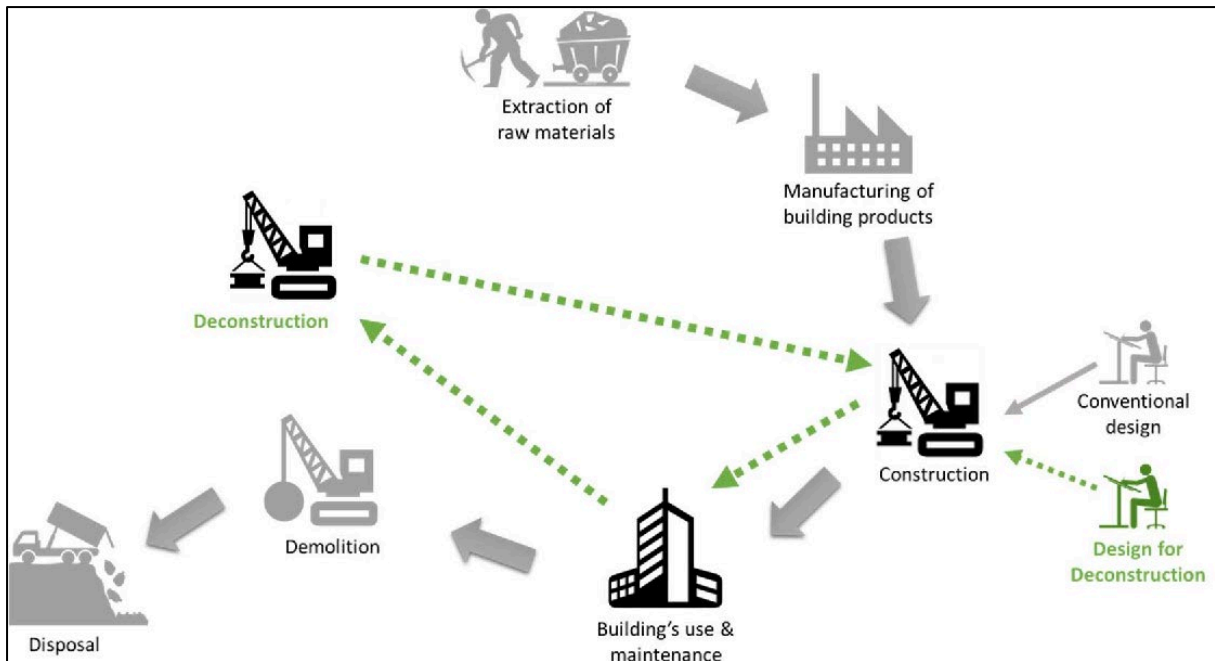

Figure 22: Circularity in C&DWM -Building life cycle with conventional method and design for deconstruction (DfD)

Introducing Circularity in C&D Waste Management

The introduction of a circular economy in the construction sector creates opportunities for innovations in cutting down on raw materials and reducing residual and waste matter, quality improvement and cost reduction throughout the lifecycle of structure and its various components.

Different approaches for introducing Circularity in managing C&D waste-

Table 7: Approaches for introducing Circularity

Construction approach	Waste Management approach	Legislative approach
<ul style="list-style-type: none"> • Design and construct for recycling and reuse • Reducing use of virgin materials • Reduction in the overall waste generation by setting construction practices standards • Integration of a demolition plan 	<ul style="list-style-type: none"> • Decentralized cluster-based approach for recycling waste • Data collection through ICT based technology 	<ul style="list-style-type: none"> • Mandate use of certain percentage of recycled waste with the new construction material • Reduce GST on recycled materials. • Setting green building standards

Construction approach	Waste Management approach	Legislative approach
• Life of the structure specified		

Application of C&D Waste Recycled Materials

To understand the circularity of C&D waste, the approaches include exploring recycling opportunities, products/by products with their applications in the market. Some of the applications identified are given in table below

Table 8: Applications of C&D Waste Recycled Material

Sr. No	Description of Item	Specification	Size	Application
1	Good Earth	Produced in the process of filtration & pressing of slurry. Slurry is generated during the washing of C&D waste.	< 75 microns	Filling in low lying areas
2	Screened Soil	Produced during the screening of C&D waste. It consists of Soil & Aggregate	< 26.5 mm	Back filling, Road construction & filling of ramp portion of the flyovers
3	Recycled Aggregate (RA)/ Brick Sub-Base (BSB) / Granular Sub-Base (GSB)	Produced by Crushing & Washing of Brick Aggregate, Stone Aggregate, Tiles etc.	4.75 mm to 26.5/53mm & 11mm-53mm	Lean Concrete (M10, M7.5 grade) & PCC work. Recycled aggregate (RA) up to 100% for lean concrete has been permitted as per IS 383:2016
4	Manufactured Sand	Produced by crushing & washing of C&D waste. It is a fine mixture of Stone & Brick Aggregates. All the properties are same as river sand except more water absorption capacity.	75 micron- 3 mm	Brick work & PCC work

5	Recycled Concrete Aggregate (RCA)/ Stone Dust	Produced by crushing concrete-based C&D waste only.	RCA- 5mm to 20 mm Stone Dust- < 5 mm	Up to 25% in Plain Concrete up to 20% In RCC & 100% in Lean Concrete. (As per IS:383)
6	CC Blocks and Bricks	Produced by mixing of recycled aggregate, sand with cement	400X200X100 mm	Used in non-load bearing areas like boundary/ partition walls

C&D Waste Value Chain:

The C&D Waste generated in the cities is handled either by ULB on its own or through 3rd Party contracted by ULBs. The process flow of management of waste in different cities is illustrated in the figure below:

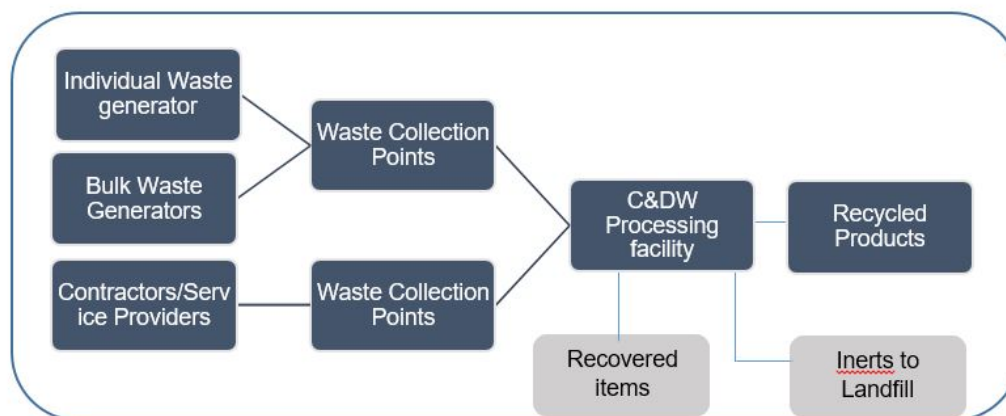
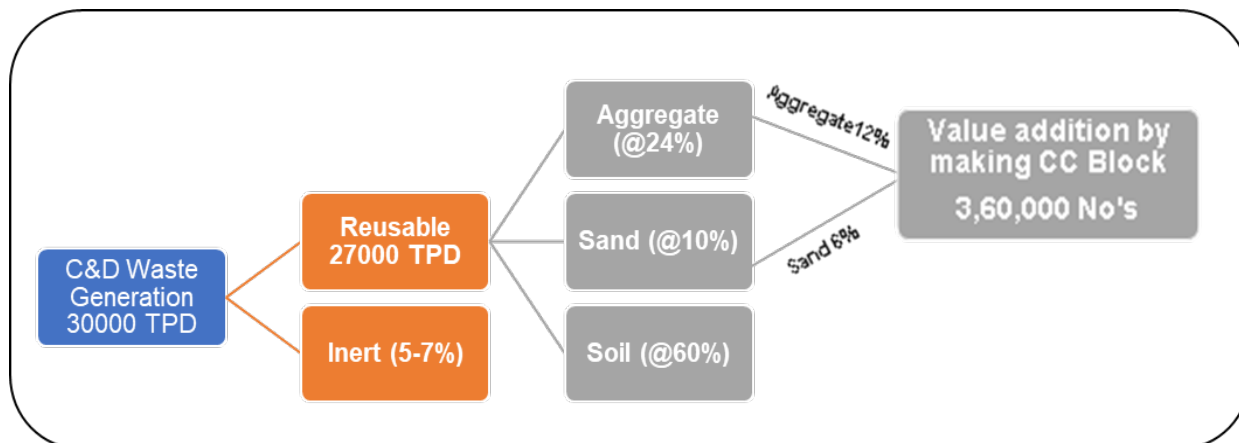

Figure 23: C&D waste Handling in India

Economic Potential of C&D Waste Management

The potential for circular economy in C&D waste can be explained from an approximate estimation of economic value, which can be derived from existing circumstances. Taking these factors into consideration, the expected economic value of C&D waste is depicted in figure 24:



: Figure 24: Economic Potential from C&D Waste

Avg. Sale Price of different fractions: (As per prevailing market rates)

- Aggregate: ₹285 per tonne (Total income @12% – ₹10.25 lakh/day)
- Sand: ₹550 per tonne (Total income@4% – ₹6.60 lakh/day)
- CC block : ₹27 per piece (Total income 3,60,000*27=97.20 lakh/day)

★ **C&D waste management have potential to generate approximately 10,000 jobs which includes Managerial, Supervisory, and unskilled positions.**

★ **Realizing potential of C&D waste value chains through Circular Economy will lead to revenue of ₹416 Crore/ year**

** Considering 50% conversion of raw recycled materials into value added products. # Significant savings to bulk waste generators by utilizing recycled C&D materials in their own consumption.*

4.4 Gaps in Policy & Regulatory framework in India

Regulatory framework for managing CDW today is as follows:

- Solid Waste Management Rules 2016 (MoEF&CC, 2016).
- Construction and Demolition Waste Management Rules 2016 (MoEF&CC, 2016).
- Management Manual on Municipal Solid Waste (MoHUA, 2016).
- Manual on Municipal Solid Waste Management (MoHUA, 2000).
- TAG report on Municipal Solid Waste Management, (MoHUA, 2005).
- National Environmental Policy, (MoEF&CC, 2006).
- CPWD Manual for Sustainable Habitat, (CPWD,2014).
- Green Building Norms, (CPWD,2012).

The existing framework for C&D waste as mentioned above has some management deficiencies. Key suggestions for improving C&D Waste Management should include

- Reinforcing regulatory compliance with strong deterrents

- Government supervision along with an economic incentive approach
- Interaction between all Stakeholders for clarity on responsibilities
- Active coordination among operational departments
- Digital monitoring setup/ Monitoring Committee to ensure fulfilment of compliances and quality of output.
- Continuous development and integration of emerging technologies.

The institutional arrangement for managing C&D waste lies with the ULBs. The main functions of ULBs for managing C&D waste generated as per C&DWM Rules 2016 are as under.

Duties of ULBs Under C&D Waste Management Rules

- Make arrangement for collection of C&D waste
- Ensure transportation of C&D waste at appropriate site
- Examine and approve waste management plan of generators
- Establish C&D waste generation database
- Device appropriate measures for management/ processing of C&D waste and use of recycled products and provide incentive/s for use of products made with recycled C&D waste

4.5 Technology Options & Business Viability Models

Technology Options

Since, C&D waste basically consists of debris of concrete, mortar, bricks and tiles, the processing usually involves segregating, crushing, downsizing, washing and sieving it into uniform size aggregate particles, that can substitute primary aggregates in the construction market. All other materials such as glass, wood, steel is reused or recycled separately.

C&D Waste Processing:

C&D waste processing can be done through wet and dry processing technologies. Wet processing is achieved through machinery capable of segregating sand from mixed C&D waste and uses water for segregation, while dry processing involves manual separation and crushing without using water for treatment. The simplified process flow for processing C&D waste is depicted in figure 25 below

C&D waste -Wet process Flow:

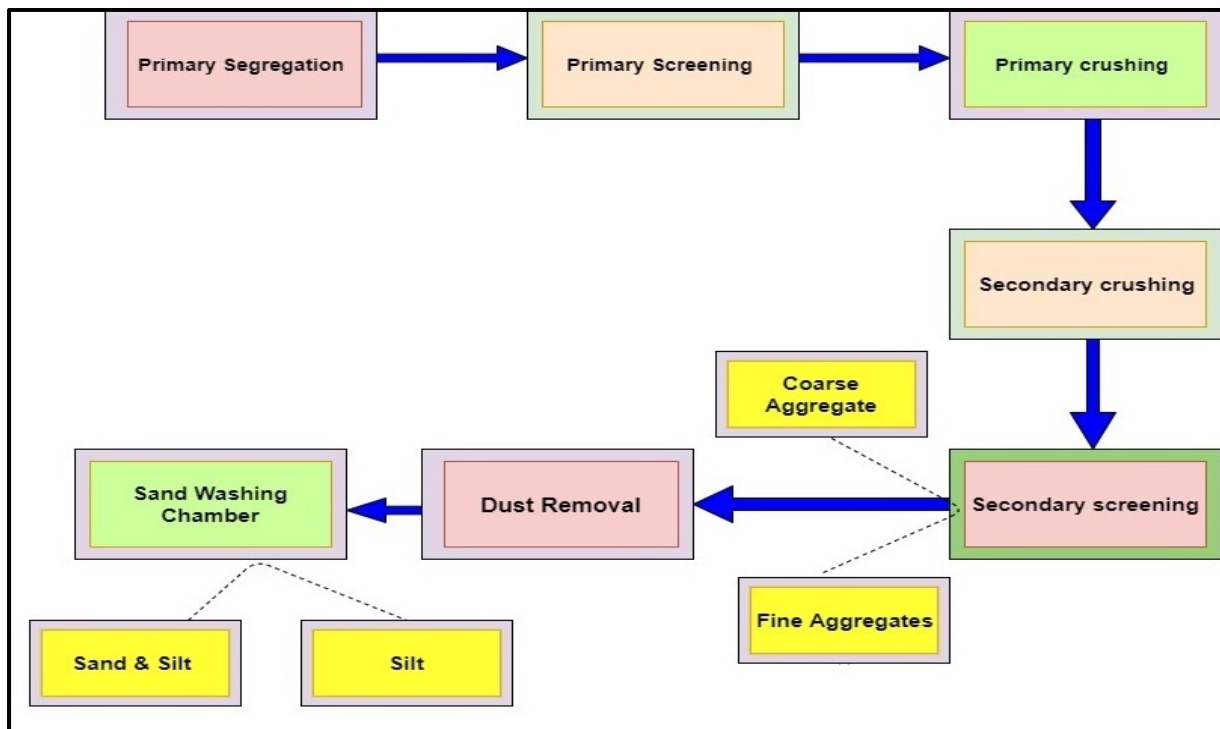

Figure 25: Process layout for Wet Processing of C&D waste

C&D waste- Dry Process Flow

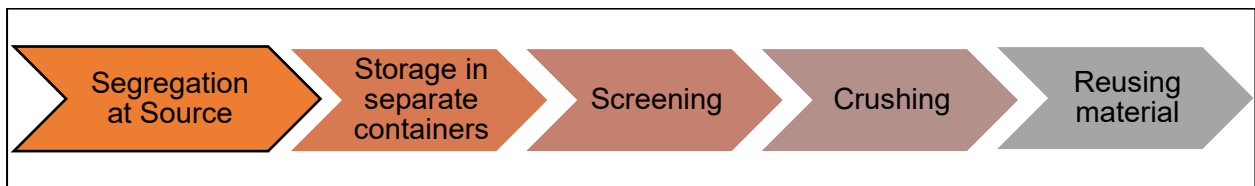

Figure 26: Process Steps for Dry Processing of C&D Waste

Types of C&D waste Processing Plants/Units

Stationary processing unit

Stationary C&D waste processing unit is mostly Wet Processing unit with assembly of crushing, sieving, and washing machinery interconnected by conveyer belts for material movement. The systems are either semi-automated or completely automated units. The capacity of stationary processing units can vary according to the need from 100 TPD – 2,000 TPD or even more.



Mobile crushing unit

Mobile crushing works on dry Processing concept. All the equipment's are mounted on the top of customised mobile unit/truck. This kind of design provides the flexibility to ensure that the crushing station can be easily transported by and moved to construction/demolition sites. These units are good to process up to 50TPD of C&D waste.



Mini mobile crusher

For small cities and towns with lesser quantity of waste, mini mobile crusher units are more viable option. The mini-crushers with processing capacities of around 5 TPD can be maintained by the ULB for processing waste into finer secondary raw material or the mini crushers can be maintained by designated pre-cast concrete building material manufacturers to whom the C&D waste can be delivered as a business model.



4.6 Comprehensive Action Plan & Recommendations

Comprehensive Action Plan: The following table summarizes the key activities for C&D waste circularity

Table 9: Comprehensive Action Plan for C&D Waste Circularity

Sr no	Activity	Action items	Responsibility
1.	Quantification of C&D waste generation and utilization pattern of C&D waste-based aggregates and products	<p><u>1a. Web-Portal Creation</u></p> <ul style="list-style-type: none"> Creation /updatation of Web-Portal to capture the C&D waste generation data: <ul style="list-style-type: none"> - Creating the baseline data through concept like “Material passport” for all the buildings and use of centralized Web -based portal for the estimation of realistic data The same web portal shall be used for monitoring the effectiveness of overall C&D waste management. The portal shall be updated on a regular basis as per the requirement. <p><u>1b. Quantification of C&D waste – Survey/ Sampling to be conducted in each population categories of cities as mentioned in this report</u></p> <p><u>1c. Utilization pattern of C&D waste-based Aggregates and products</u></p> <ul style="list-style-type: none"> ULB should estimate the construction activity / pattern and the possible maximum utilization of C&D Waste based aggregates and products in their construction activity 	States / ULBs
2.	Collection of low volume C&D Waste at Collection points and its outbound logistics to the processing plant	<p>Number of collection points in a particular ULB depends upon its coverage area and the area of collection & storage point depends upon the population living in the coverage area. It also depends on the projected rate of generation of C&D waste.</p> <ul style="list-style-type: none"> It is advisable to have at least one collection point for a coverage area of 5 sq. km having population of 25,000. Such Collection & storage point should have an area of 200 sq. m (base area). 	ULBs

		<ul style="list-style-type: none"> An additional area increases by 100 sq. m may be provided for each 25,000 increase in the population in the same 5 sq. km of coverage area <p>For low volume waste generator(s), generator shall make their own arrangements or hire services of agency approved by ULB for the collection and transportation of C&D waste from the source to collection point (on call facility). The outbound movement of C&D waste from the collection point to the processing plant shall be managed by the processing plant agency. The terms & condition for such transportation and other formalities shall be arranged by ULB's with the processing plant</p>	
3.	Collection of Bulk C&D Waste and its outbound logistics to the processing plant	<p>ULB shall establish linkage for bulk C&D waste generators (sources generating more than 20 tons or more in one day or 300 tons per project in a month) and processing plant agency for the collection of C&D waste.</p> <p>The Tri-Partite Agreement between the ULB's, bulk C&D waste generators and processing plant shall be done to finalize the terms and conditions and other formalities for collection at source and sending it directly to the processing plant.</p>	ULBs
4.	Processing plant	<p>Minimum 2-acre land is required for the setting up of C&D waste processing plant (wet process based) for 50-100 TPD C&D waste.</p> <p>For every additional 100 TPD C&D waste, an additional 1-acre land for the establishment of C&D waste plant is required.</p> <p>For setting up of a C&D waste processing plant, a minimum of 100 TPD C&D waste generation is essential. Mobile crusher unit (dry process based) may be used when C&D waste generation is less than 50 TPD or where ULB's are small.</p> <p>It is suggested that ULBs and District administration should be encouraged to</p>	ULBs

		experiment with different models of public-private partnership, small business / start-up services for the set-up and management of C&D waste processing plants	
5.	Promoting utilization of C&D waste recycled products	<p>The utilization of C&D waste recycled products should be promoted at three levels namely ULB/District level, State Level and National Level.</p> <p>a) ULB's / District management should aim to consume 100 % of C&D waste recycled products in their own construction activities and they should include these products in their Schedule of Rates and Construction Tender document(s).</p> <p>b) In construction activity controlled by State, ULBs should engage with State government agencies like PWD, rural road department, development authority, irrigation department etc. for the utilization of C&D waste recycled products through inclusion of such products in their Schedule of Rates and tender document(s).</p> <p>c) At National level, MoHUA/ CPCB should engage with agencies like CPWD, MoRTH, NHAI, NRRDA etc. for the promotion of C&D waste products. Efforts should be made to include these products in the Schedule of Rates and tender document(s).</p>	To engage with various stakeholders such as CPWD/PWDs, BIS, GRIHA/IGBC, BMTPC, etc.
6.	Policy interventions	<ul style="list-style-type: none"> • GST for C&D waste products shall be reduced from 18% to 5%. • Green tax for the transportation of C&D waste products should be waived off for C&D waste products. • Electricity load in C&D waste plant charged at industrial rate shall be reduced suitably. • It is suggested to have single window environmental clearance for setting up of a C&D waste processing plant. 	Government of India/ State government/ ULBs

7.	Standardization and Research needs	<ul style="list-style-type: none"> • Separate BIS / IRC Guidelines for utilization of recycled products produced from C&D Waste should be prepared. • Research work should be promoted to enhance the usage of C&D waste products for various non-structural and structural applications. For e.g. as per the IS 383 (latest revision), use of recycled concrete coarse aggregate has been permitted as replacement of virgin coarse aggregates up to 25% in plain concrete works, up to 20% in reinforced concrete works (up to M25 grade), and up to 100% in case of lean concrete works. • Usage of recycled fine aggregates for masonry and plaster works applications should be included in BIS / IRC Guidelines 	NCCBM, CRRI and other R&D institutions, BIS, IRC
----	------------------------------------	--	--

Remarks

- Issue of segregation of C&D waste can be dealt at the collection point.
- The distance between the C&D waste processing plant and collection point shall be within 40 km.
- For the establishment of C&D waste processing plant in ULB with more than 1 lakh population, detailed project report (DPR) should be prepared that must include details regarding the proposal to ensure natural resource's conservation
- Mobile crusher units are not preferable because of environmental concern.
- Eco-Mark label should be adopted
- Green certification of a building can be done on the basis of products rating
- At the national level, Ministry of MSME may be brought in to promote SMEs and start-ups in C&D waste conversion businesses, supported with green finance and fiscal benefits as suggested in this report.

Recommendations

To develop comprehensive measures for progressing towards a circular economy with efficient strategies, the recommendations are as follows categorized in the table 10 below:

Table 10: Recommendations for C&D Waste Circularity

C&DWM Focus Area	Recommendation
Building Design and Construction	<ul style="list-style-type: none"> • Use longer Design Life of buildings with modular approach. • Reducing virgin material use, e.g. use of 20% secondary materials in new building construction: 40% in Roads and Highways. • Building products and materials with secondary resources should be given tax rebates • Reduction in the overall waste generation by setting dismantling standards and SOPs • Transparency in FAR, demolition plan, data on construction material and declaration of life span of the building from the planning phase. • Cluster based C&D Waste recycling plants, at least one in cities with >10 lakh population • Mobile-based data collection system on types of C&D waste being generated. • Define green building standards on C&D waste utilization, Lifespan of the building, demolition plan, energy usage, natural resource usage, usage of reusables. This could be promoted on incentives and award system
Waste Segregation and Policy Intervention	<ul style="list-style-type: none"> • Mandatory Segregation and channelizing of the C&D waste • Waste generators must pay charges for collection, transportation, processing, and disposal as notified by the concerned authorities. • Concession agreements with processing plants should be for minimum of 15 years. • Municipal Corporations/ULBs should ensure buy-back of the recycled material from the processing plants through building permit system. • Reduction of GST on C&D waste processed products from present applicable rate of 18% to 5%. • Exemption of Green tax on C&D Recycled products and transportation.

<p>Data and Resource Assessment:</p>	<ul style="list-style-type: none"> • Life Cycle Assessment (LCA) and Material Flow Assessment (MFA): To steer the housing and infrastructure development towards resource efficiency. • MFA will aid LCA based procurement and reduce environmental impacts Combining LCA and MFA is an innovative tool for sustainable decision making. • Reliable data for assessing environmental cost of material flow and to establish potential of secondary materials.
<p>Factoring Environmental Costs & Leveraging benefits from C&D waste utilization</p>	<ul style="list-style-type: none"> • Secondary resources to partially replace virgin resources (recycled aggregates and fine aggregates) • The intent of the national level policy for achieving resource efficiency in the construction sector needs to be translated to a roadmap for action at the State and city level.
<p>Utilization of C&D Wastes in buildings and infrastructure:</p>	<ul style="list-style-type: none"> • All construction projects – both buildings and infrastructure should prepare demolition plans and segregation plans for C&D waste management as the part of building plan approvals submitted to the municipality/ competent authority, as applicable. • A threshold level mandatory proportion of C&D waste use in all public and private buildings / infrastructure would be useful to ensure its circularity. • The utilization of the C&D waste incentivized through reduced GST and or other fiscal incentives.
<p>Recycling and Application of C&D Waste</p>	<ul style="list-style-type: none"> • For Roads, C&D waste can be recycled to produce aggregates for drainage material; shoulders; stabilized as well as un-stabilized base courses; bituminous concrete; lean mix; sub-bases as well as new concrete pavement. • Tunnel muck can be used for producing RCA after proper characterization for road applications. • Potential applications for structural grade concrete produced from RCA could be codified by BIS

Chapter 5:

Report of Sub-Committee on Recycle and Reuse of Treated Municipal Sewage (Wastewater)

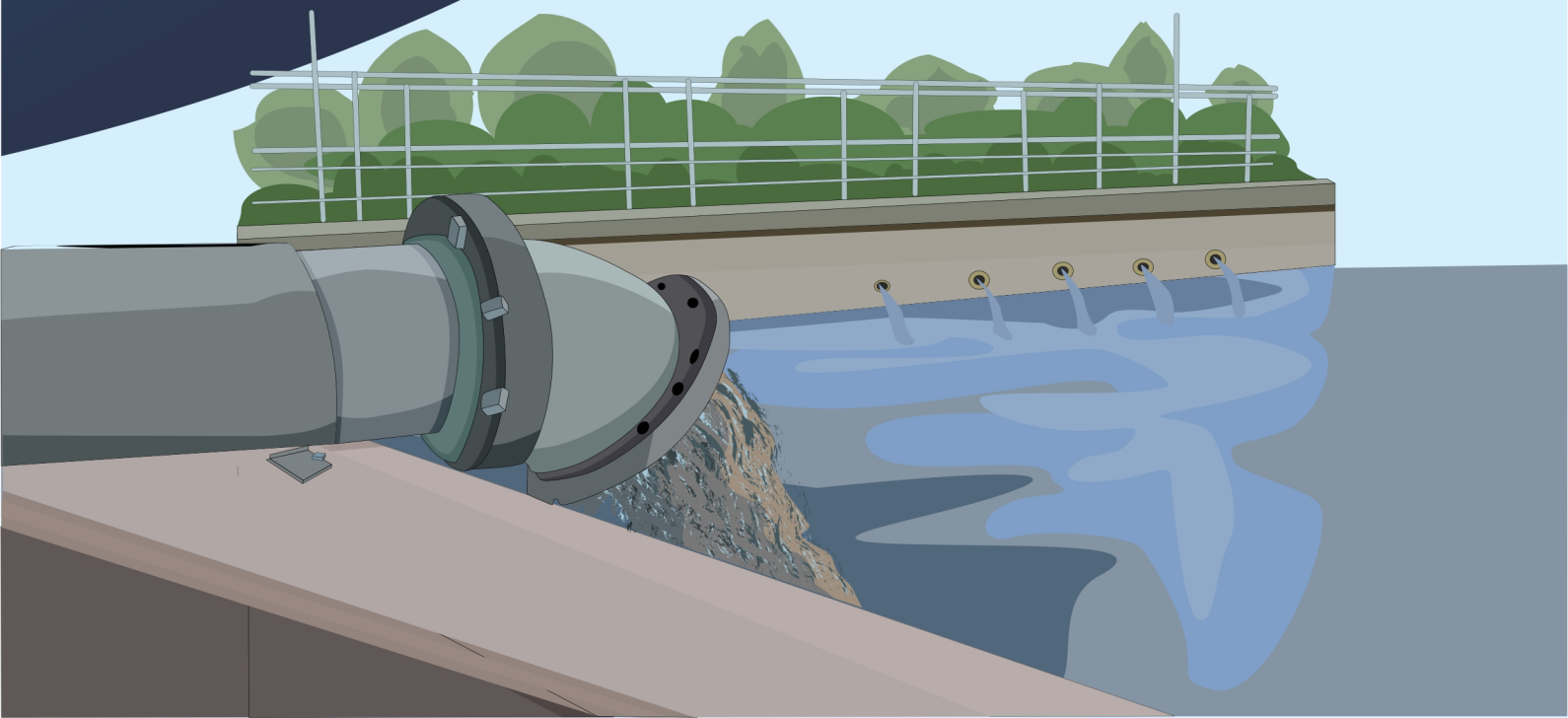

5.1 Introduction

Context

India is home to 17% of world's population while it holds only about 4% of global water stock. The urban and rural areas, along with agriculture and industries are dependent on the same water resource. Agriculture stays as the major consumer of water in the country with net demand of 688 billion cubic meters (bcm) per year which is about 85% of the total water demand. It is followed by industrial sector demand at 9%,²⁵ while the potable water demand (urban and rural) is assessed to be at about 6%.

Ground water and surface water are the only possible sources of obtaining water. To meet the increasing demand, alternate sources of water are being explored. According to the Central Pollution Control Board (CPCB, 2021), currently urban India generates 72,368 MLD of municipal sewage which is estimated to increase to 1,20,000 MLD by 2050. **This treated sewage, already available in vicinity of points of use, can be a viable resource to offset part of the increased requirement for non-potable applications of water in agriculture, industry and municipal domains, thus bringing in circularity in water- wastewater sector (Figure 27).** This is dependent on the premise that the generated sewage is treated to appropriate level. CPCB has estimated that installed sewage treatment in the country today stands at only 44%.

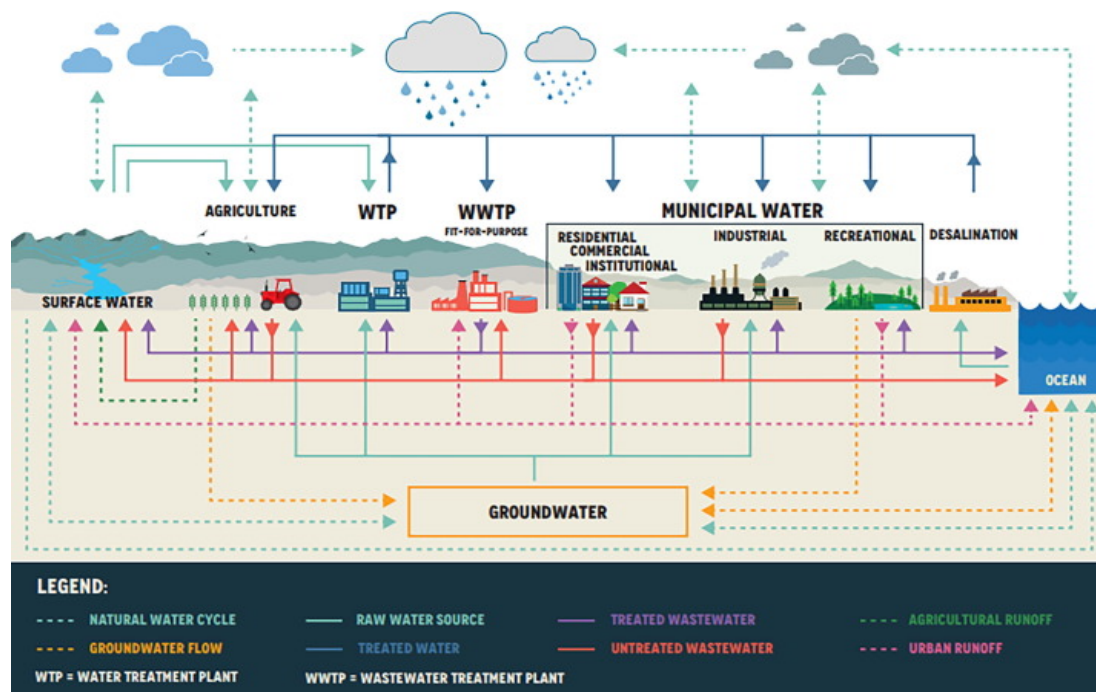

Figure 27: Wastewater in the water cycle (Source: WWAP)

²⁵ Source: Statista, 2021

5.2 Potential for Circularity in Water- wastewater Sector

The framework for circular economy for the water - wastewater sector, is based on the general waste mitigation principles, i.e.- reduction, reuse, recycling, and recovery (Figure 28).

The policy recommendations on wastewater recycling and reuse being suggested in succeeding paragraphs are expected to yield several benefits, including, but not limited to, the following:

- **Recycled wastewater can be an additional source of water** to free up freshwater used for non- potable use.
- **Source of revenue for utilities** through sale of secondary treated wastewater can recover some of the O&M costs of STPs.
- **Economic and environmental benefits** due to reduced extraction of groundwater, and conveyance of water over extended distances which reduces pumping energy requirement and costs.
- **Incentives for ULBs to strengthen sewerage and treatment infrastructure** by realizing the value of collection, treatment, and recycling of sewage.
- **Social benefits** through improvements in productivity and wellbeing of citizens because of obvious health and environmental benefits.

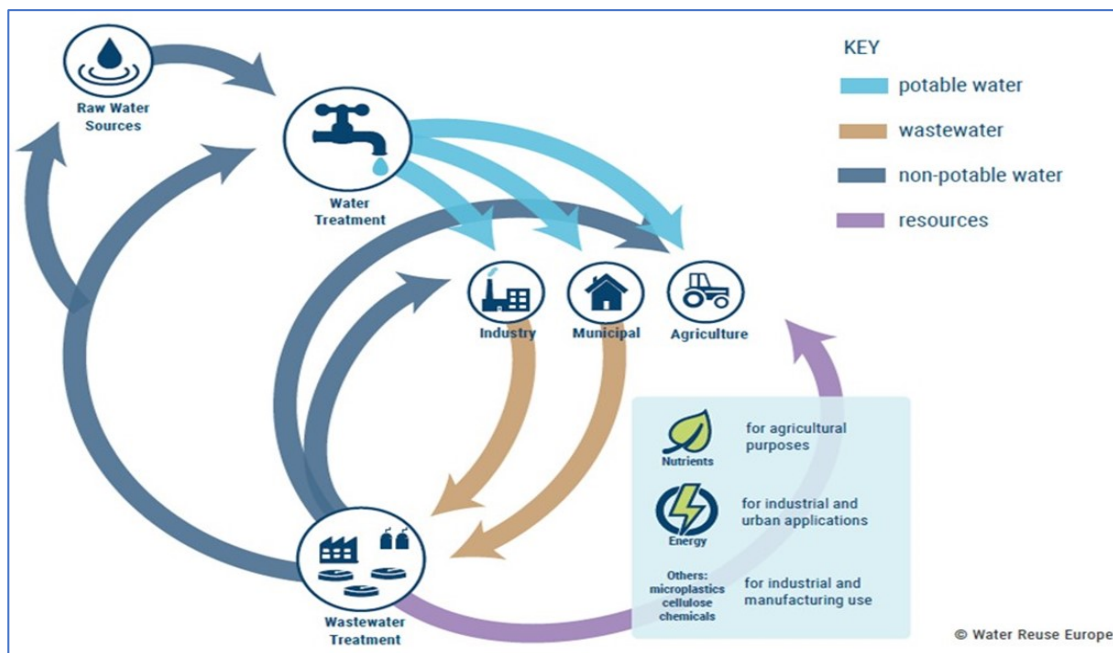

Figure 28: Water in Circular Economy
(Source: Water Reuse Europe Review 2018)

- **Financial benefits**
 - The sale of treated sewage has potential to generate revenue ₹3,285 crore annually in India (conservative estimate).
 - Every hectare that is irrigated through treated wastewater can increase farmer's earning by ₹17,000 per hectare annually.
 - Considering the substitution potential of wastewater irrigation and assuming a reduction of pumping use by at least a third of the current use in the wastewater-irrigated areas, the savings in grid electricity supply requirements would be significant and are estimated to save (the state government and the electricity utility) about ₹600 crores annually or ₹1.6 crore daily.
 - The economic value of nutrients recovered from sewage is approximately ₹1,095 – 1,460 crore per annum.
- **Environmental benefits**
 - An estimate suggests that use of wastewater for irrigation instead of pumping of ground water has the potential to save about 1.75 million MWh of electricity annually, which is equivalent to reducing about 1.5 million tons of CO₂ e (tCO₂) GHG emissions.
 - Replacing chemical fertilizer usage by 20% in 2-million-hectare irrigated land, alone leads to reduction of 4,71,237 tons of CO₂ equivalent (Refer to Table 15).
 - Approximately 3,888– 5,256 tons of nutrients can be recovered from the generated sewage every day (Refer to Table 14).
- **Employment generation**
 - An estimated 1800 people can be directly employed to undertake the additional tasks related to management of supply of treated wastewater.

**The above-mentioned estimates are taken from 'Recycling and Reuse of Treated Wastewater in Urban India' advisory published by IWMI.*

5.3 Current Approach and Challenges

General approach to treatment of wastewater for reuse

The Manual on Sewerage and Sewage Treatment Systems (2013) discusses in detail the different types of treatment technologies suitable under different conditions, including decentralized wastewater treatment technologies. In the case of wastewater reuse projects, the quality of treated water will vary based on the type of end use and the related standards prescribed. An overview of additional incremental technology interventions required to achieve different end uses of recycled water mentioned in (Figure 29).

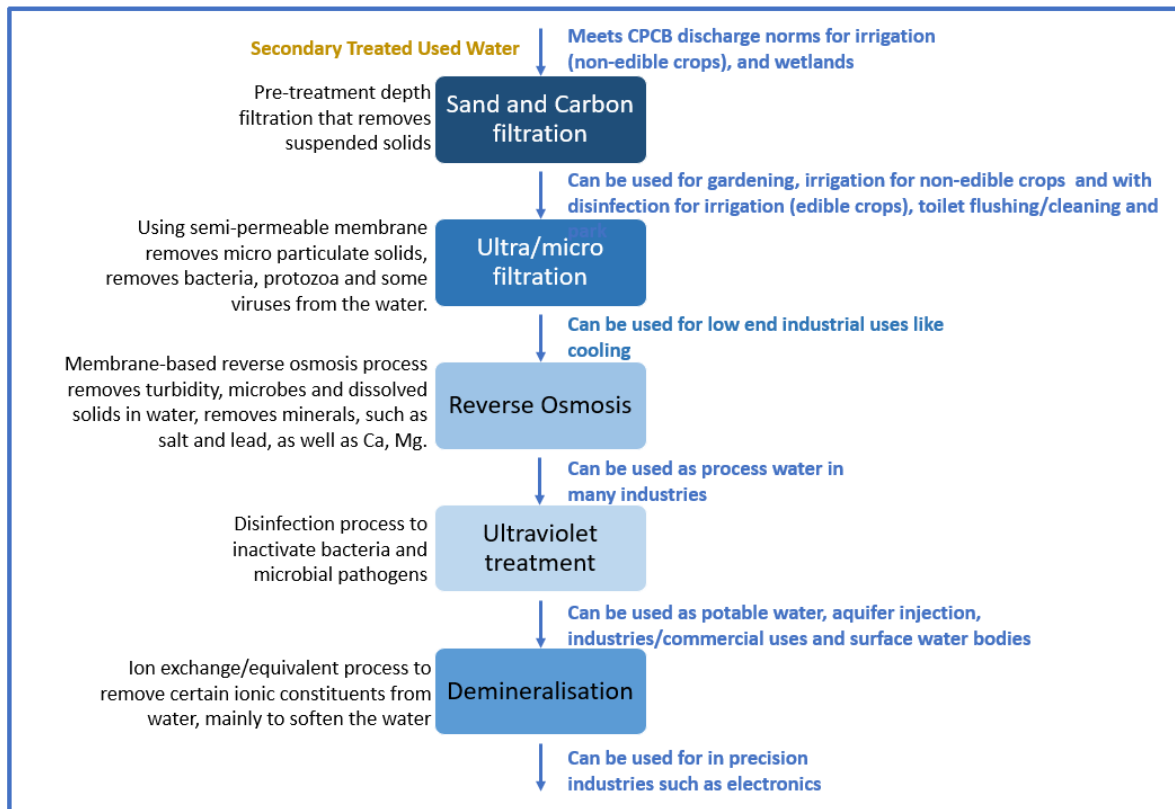

Figure 29: Incremental Technology interventions to achieve End Use Water Quality Standards (Source: Draft National Policy on the Safe Reuse of Treated Wastewater, India- EU Partnership)

Besides technical aspects the choice of technology should be based on sound financial assessment of the investment required, scale of operation, the appetite for treated wastewater in the region, and customer profiles and their willingness to pay for the treated water.

Municipal Wastewater Recycling & Reuse in India – Status

The National Water Policy-2012, encourages recycling and reuse of water after treatment to specified standards. Ministry of Housing and Urban Affairs has also issued various advisories pertaining to urban sanitation from time, including wastewater recycling and reuse. Manual on Sewerage and Sewage Treatment Systems (2013) (CPHEEO 2013) covers recycling and reuse of wastewater in depth and its provisions act as national norms.

CPCB has estimated that 28% of total generated sewage is treated in the country whereas there is 44% installed capacity. A **substantial volume of the municipal wastewater- both treated as well as untreated, is being discharged unused. This often finds its way into agricultural irrigation- albeit indirectly.**

Recently, some progressive ULBs and concerned authorities have been trying to focus on planned reuse of treated wastewater in horticulture, irrigation, industrial processes, construction activities etc.

State Governments of Gujarat, Haryana, Maharashtra, Rajasthan, Chhattisgarh, Karnataka, and Madhya Pradesh have either adopted, or are moving forward with, treated wastewater reuse policies that seek to reduce dependency on freshwater resources.



Figure 30: Aerial view of Sewage Treatment Plant

There are very few examples of successful municipal wastewater recycling and reuse projects, implemented in India. Some cities such as Chennai, Nagpur, Udaipur, and Surat are supplying recycled water to local industries.

International Approaches towards Wastewater Recycling & Reuse

Globally, almost one third of reclaimed water (32%) is used for agricultural irrigation (Figure 31). This is followed by landscape irrigation²⁶ (20%) and industrial uses (19%).²⁷

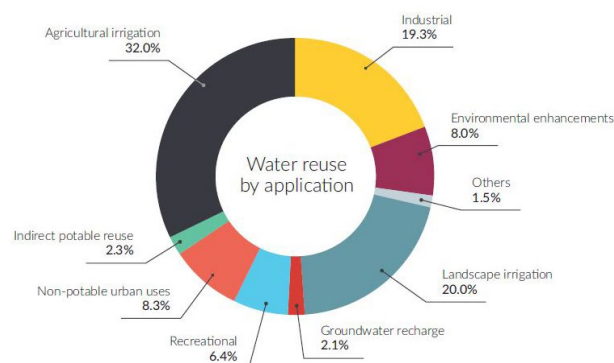

Figure 31: Global water reuse after advanced (tertiary) treatment: Market share by application (Source: Lautze et al. (2014)²⁸)

Landscape irrigation refers to usage of treated wastewater in maintaining parks, lawns, green patches, horticulture, etc.

²⁷ Global Water Intelligence, 2016 in Ohkuma N, 2016

²⁸ www.iwmi.cgiar.org/Publications/wle/rrr/resource_recovery_and_reuse-series_4.pdf

Experience of European Countries

Over the years, the European Union (EU) has developed a portfolio of directives to regulate the water cycle which are of major importance for implementing water reuse schemes. Water Reuse Europe is the central body monitoring the water reuse sector in the EU. It has identified 787 reuse schemes the year 2017, distributed across 16 countries up from 350 schemes identified in 2006. Until year 2000, EU regulations, standards or guidelines to regulate water reuse were almost non-existent. The evolution of regulatory adopted by EU is presented in Figure 32.

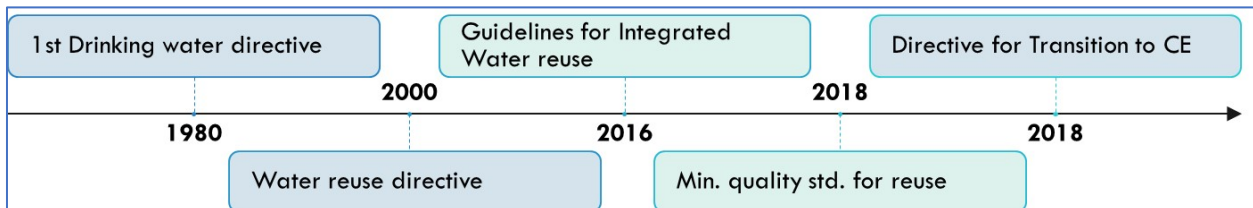

Figure 32: EU - Timeline of regulatory initiatives relating to water reuse
(Source: Water Reuse Europe Review 2018²⁹)

Experience of USA

US Environment Protection Agency (US- EPA) has been the pioneering global agency to promote various developments in water- wastewater sector and has published considerable techno-managerial literature on the subject of water reuse.

Beneficial use of wastewater has been practised in California since 1890s, when raw sewage was applied on 'sewer farms'. Recently, to further accelerate the consideration of water reuse approaches and build on existing science, research, policy, technology, and national and international experiences, US- EPA has engaged stakeholders to develop a National Water Reuse Action Plan (Figure 33)³⁰.

²⁹<https://www.water-reuse-europe.org/about-water-reuse/policy-and-regulations/#page-content>

³⁰<https://www.epa.gov/sites/production/files/2020-02/documents/national-water-reuse-action-plan-collaborative-implementation-version-1.pdf>

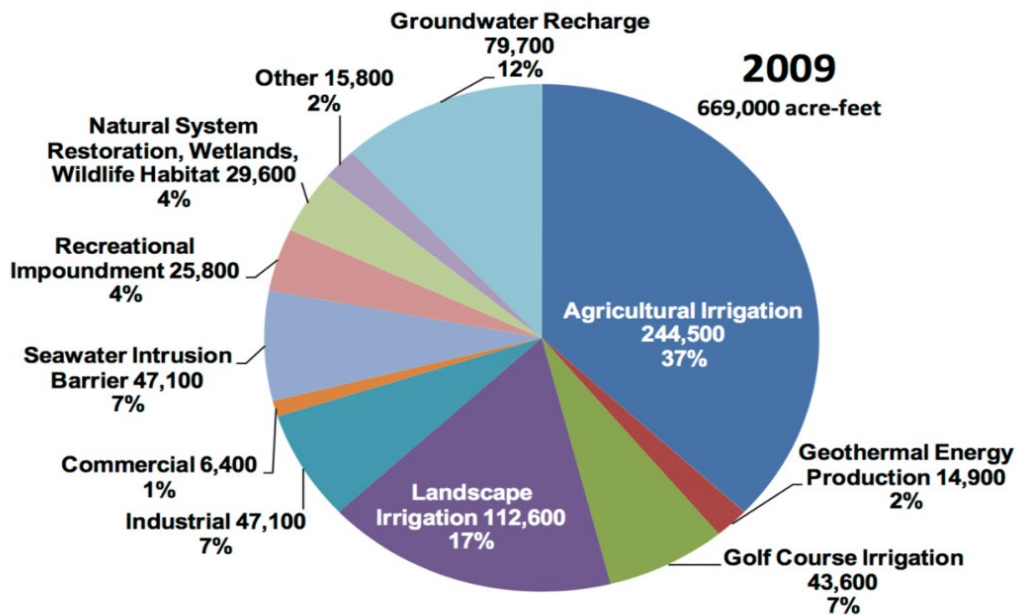

Figure 33: Water consumption pattern in water scarce state California, USA

Other Global Instances:

Some of the other widely known international practices of wastewater recycling and reuse are as follows -

- Singapore successfully commissioned “the Newater system” (recycled water) to fulfil 40% of national water demand including non-potable use such as industrial and air-cooling purposes as well as for indirect potable usage by blending it with water reservoirs.
- Comprehensive wastewater recycling and reuse programmes are being executed in the USA, the EU and more recently China over the last 20-30 years. These nations have taken several steps, learning from successes and failures. India may take advantage of their experience and devise long term plans to achieve CE in wastewater recycling and reuse.

Policy and Regulatory Framework in India

Existing Regulations on Municipal Wastewater Recycling & Reuse

There is no dearth of policy initiatives focussing directly or indirectly on wastewater reuse in India (Figure 34). The awareness at national level had commenced back in 1974, however, the intensity of executing reuse plans has been as recent as in 2013. Based on CPHEEO norms on reuse of wastewater, cities have taken various policy decisions with respect to wastewater recycling and reuse.

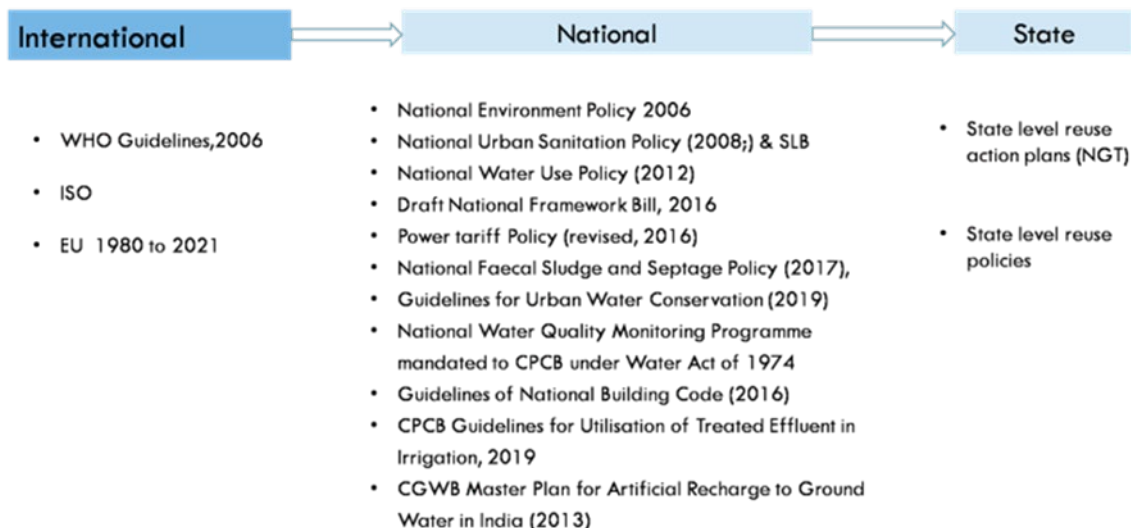

Figure 34: Regulatory Framework for Wastewater Recycling & Reuse

State-level policies and regulations:

Many states have come out with their own policies on wastewater recycling and reuse loosely based on the CPHEEO 2013 guidelines. Further, some states have prepared Action Plans on wastewater recycling and reuse as per the recent NGT directives. These states include Chhattisgarh, Delhi, Andhra Pradesh, Gujarat, Jammu and Kashmir, Jharkhand, Karnataka, Madhya Pradesh, Punjab, Haryana, Rajasthan, Puducherry, Telangana, and Daman. Tamil Nadu has also prepared the Draft Reuse Policy.

- **Andhra Pradesh Action Plan** recommends mapping of bulk users to quantify their demand, and promotion of use of recycled water for industrial parks. Whereas **Telangana Action Plan** on wastewater recycling and reuse (Aug 2019) largely focuses on the reuse potential in and around Hyderabad Metropolitan area.
- Some of these differences stem from differing priorities of states based on current water availability and use. **Punjab Action Plan** for Reuse of Treated water (June 2020) specifically gives the first preference for reuse of treated wastewater for irrigation while other states did not specify irrigation as primary option for reuse.
- **Delhi Jal Board** prepared the Action Plan on wastewater recycling and reuse in April 2019. It mentions about provision of incentives such as reduction of sewerage O&M charges from 60% to 10% for the institutions that plan to set up decentralised STPs and reuse recycled water.
- The **Tamil Nadu Draft Reuse Order** (June 2014) focuses on sale of Secondary Treated Effluent Water (STEW) to different end users. The tariff of STEW shall be fixed as per prevailing rate of Chennai Metropolitan Water Supply & Sewerage Board for the base year (2014) with annual escalation of 5%.

5.4 Gaps in Policy and Regulations

Gaps in policy and regulations are as follows-

- While policy and guiding frameworks in India recognize the need for wastewater recycling and reuse, there has been little in terms of detailed guidance.
- Overlapping of mandates of institutions leading to operational issues on ground.
- Lack of appropriate regulatory standards for treated water quality dependent on intended reuse
- Lack of adequate monitoring and quality control systems
- State action plans or policies need to be further co-ordinated/ modified to align with the national action plan-
- **It is expected that the proposed action plan leads to the development of guidance material on planning, development and implementation of successful projects and interventions in wastewater recycling and reuse and create an enabling environment for innovation in technologies and institutional arrangements**

Potential Users of Recycled Water:

Agricultural irrigation for crops not likely to be eaten raw, followed by cooling needs of thermal power plants and urban landscaping remain the major potential users of treated water in terms of volumes engaged. There could be a great variety of other potential users at any specific place. A few examples are mentioned in (Figure 35).

Potential Industrial Users:

The Power sector is a major consumer of water.

In 2010, the water demand of industry and energy sectors was 17 billion cubic meters (bcm) which was expected to increase to 63 bcm in 2025 and 130 bcm in 2050. However, at many places, especially in organised industrial estates, due to enforcement of the Zero Liquid Discharge policy, net water demand for industrial reuse could have since reduced/ stagnated.

Conventional 'once through' type thermal power plants are expected to be the principal consumers among industries. The thermal power plants take up almost 88% of water needs of the industry. Other major water guzzling industries like pulp and paper (2.2%), textiles (2%), steel, (1.3%), sugar (0.5%), fertiliser (0.2%) have a combined intake of less than 5% of the overall water consumption. Almost 90% of India's thermal power generation is dependent on freshwater for cooling. Some of the larger thermal power plants have potential to consume almost 400-500 MLD of recycled water per day. In December 2015, however the MoEF&CC has brought out a notification that sets limit on water use per unit of electricity generated. This notification has directed power

plants to set up water cooling and reclamation facility at the site itself thus significantly reducing the requirement of treated municipal water in times to come.

The **pulp and paper industry** is the second major consumer of water within industrial sector. Approximately 72% of India’s pulp and paper industries are concentrated in Andhra Pradesh, Gujarat, Odisha, Karnataka, Maharashtra, and West Bengal³¹.

Textile Industry is the third largest consumer of water of industrial sector. Major textile processing hubs in India are located in Surat, Saurashtra, Ahmedabad, Tirupur, Coimbatore, Erode, Ludhiana, Kanpur, Solapur, Ichalkaranji, etc

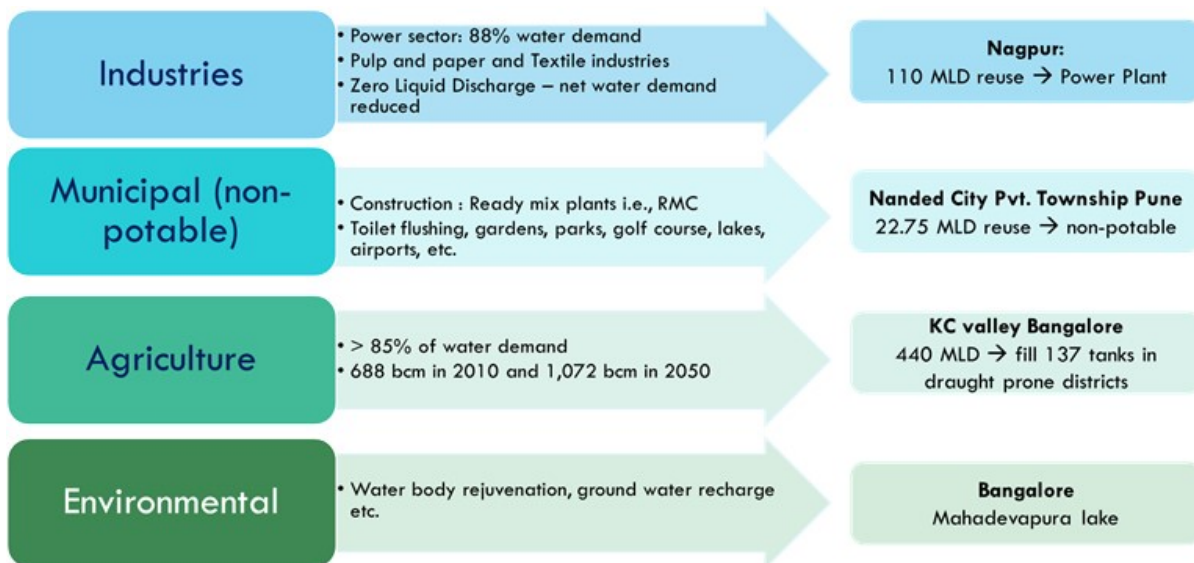

Figure 35: Case studies of wastewater reuse projects in India

India’s experience in Reuse for industries:

There are a few exemplary wastewater recycling projects in India. Some are highlighted hereunder:

Chennai Metropolitan Water Supply and Sewerage Board (CMWWBSB), in 1991, started supplying 36 MLD of secondary treated effluent from Kodungaiyur STP to the Chennai Petroleum Corporation Ltd., Madras Fertilizer Ltd., and Manalo Petro Chemicals. In 2019, it commissioned two Tertiary Treatment Reverse Osmosis (TTRO) projects of 45 MLD each at Kodungaiyur and Koyambedu which supplies water to industries around Chennai.

Surat Municipal Corporation (SMC) has replaced its potable water supply to Textile industries with 40 MLD of recycled water. Currently, Surat is recycling 302 MLD i.e., 32% of total treated sewage and supplying it for industrial, agriculture and

³¹<https://forum.valuepickr.com/t/jk-paper-best-bet-in-paper-sector/19880>

gardening purposes. SMC has prepared a comprehensive plan to upscale reuse with a target of consuming 79% of treated sewage.

Reuse Standards for Industrial uses

The industrial applications majorly include - cooling water, re-circulating or evaporative cooling water, boiler feed water, process water and irrigation and maintenance of landscape. The CPHEEO manual on Sewerage and Sewage Treatment Systems, provides details of input water quality guidelines for above mentioned various uses. Indian standards for quality tolerances for a few industrial uses are noted below:

- IS: 201 Water quality tolerances for the textile industry
- IS: 2724 Water quality tolerances for the pulp and paper industry

Generally, all the processes in an industry do not require water of the relatively high quality given in the above noted Indian Standards. There are always several unit processes and operations where water of lower quality can be accepted.

Agriculture Uses

In 2010, the agricultural irrigation sector consumed 688 billion cubic metre (BCM) (1885 Billion litres per day) compared to wastewater generation of just 72.368 Billion litres per day. This sector is expected to remain the highest water consuming sector even in the future, despite improved irrigation techniques. It is estimated that agricultural irrigation will require 910 and 1,072 BCM of water in 2025 and in 2050, respectively.

While the agricultural fields needing irrigation as well as the agro-industries are spread over vast geographical areas in the country, but are fields catering for human consumption are more concentrated in fringes of Municipal Areas. The share of agricultural sector in overall water demand is 88%. Around 25% of this irrigation demand- in areas adjacent to urban centres and in fields catering for crops not to be eaten raw can easily be met and which will exhaust the entire treated municipal wastewater discharge. This treated water can also be ponded and stored for dry weather use.

Bangalore: The minor irrigation department of Karnataka pumps 440 MLD of secondary treated wastewater from Koramangala and Challaghatta valley (KC Valley) STPs to the drought-prone districts of Kolar and Chikkaballapur. The treated wastewater is pumped to fill up 137 tanks in two districts for irrigation. This project is one of its kind in Indian agricultural sector.

Phagwara, Punjab: Under this project, approximately 12 kilometres of sewer network has been laid from STP to supply recycled water for irrigation purpose. The farmers

were well trained to operate the project which is now led by water user association formed amongst beneficiaries of the project.

Reuse Standards

Legal restrictions on growing crops and vegetation in agricultural land using sewage water are generally based on possible pollutants and pathogens which pose threat to health of the farmers as well as the consumers. CPCB has identified water quality requirements in terms of a few chemical characteristics, known as primary water quality criteria. Further, Bureau of Indian Standards also recommended water quality parameters for different uses in the standard IS 2296:1992. Guidelines are available to evaluate quality of water for irrigation. **However, there are no standards available on maximum permissible concentration of toxic trace elements in irrigation water in Indian standard for irrigation water quality.**

Under such situation, India may adopt maximum permissible concentration of toxic trace elements (As, Cd, Co, Cr, Cu, Ni, Pb, Se, Zn) in treated wastewater as recommended by FAO. No standards are available to monitor permissible concentration of pathogenic microorganisms in irrigation water in India.

Municipal Uses

The non-potable water uses in municipal areas includes (i) Landscape irrigation (ii) Impoundments/ lakes (iii) construction activities, (iv) recreational activities such as golf course, parks, playgrounds, and stadiums, and (v) other uses such as washing of vehicles, dust suppression on roads, flushing of toilets, firefighting, social forestry, and road-side plantations.

Landscape irrigation is a major consumer of treated wastewater in modern growing urban centres and smart cities. With an aim to increase the green-blue spaces in urban centres, treated wastewater in bulk can be consumed in such developments along with urban impoundments and lakes.

Construction activities: Construction activities within cities (buildings townships, roads, railways, and metro-rail, bus depots, and airports) has a potential to use recycled water. Additionally, recycled water can be supplied for other non-potable uses in railways, airports, and townships etc. The total real estate stock added in India during 2019 was 200 million sq.ft.³². The total estimated water demand of the real estate sector in India was 37.2 million m³ in 2019 (101.9 MLD). Ready mix concrete

³²<https://www.ibef.org/industry/real-estate-india.aspx>

plants (RMC), utilised 6,740 Million Litres of water to achieve estimated concrete production of 22,46,262 cum/month in India.

Private townships: A large number of private townships have come up during the last decade. These townships consume recycled water for non-potable purposes such as construction activities, toilet flushing, gardening, HAVAC, dust control, car wash, misting and others.

Nanded City is a 700-acre private township situated in Pune, housing more than 30,000 residents. It recycles and reuse around 22.75 MLD of wastewater for toilet flushing, horticulture, and HVAC cooling make up water. More than 50% of total water demand is met through recycled wastewater³³.

Delhi and Mumbai Airports have demonstrated reuse for non-potable purposes such as horticulture. Southern Railways is using recycled water for washing of wagons. In case of Coimbatore, a portion of treated effluent from Ukkadam STP is transported through pipeline to Vellalore lagoon and from there around 300 KLD of the treated effluent is supplied to the Golf Club. In Bangalore, 4MLD of wastewater is recycled and reused for gardening in Cubbon park that is spread over 177 acres.

Reuse standards:

Recycled water can also be used for municipal uses like landscaping, parks, toilet flushing and firefighting. However, as these activities may involve close human contact appropriate norms are required to be per prescribed by CPCB.

Environmental Use

The environmental uses include recharge of lakes and water bodies, and aquifer recharge. The Government of India (GoI) has prioritized conservation of water bodies by creating the new Jal Shakti Ministry and announcing the Jal Shakti Abhiyan which is a mission-mode water conservation campaign. The five intervention areas cover – rainwater harvesting, renovation of water bodies and tanks, reuse and recharge structures, watershed development and intensive afforestation. In addition, the National Mission for Clean Ganga (NMCG) released a manual cum concise guide for River Restoration and Conservation.

Water body/ lake rejuvenation. Mahadevapura Lake in Bangalore is rejuvenated jointly by the government, private players, community and national and international non-profit organizations. A DEWATS based wastewater treatment plant of 1 MLD

³³ Application for Amendment & Extension of Validity in Environmental Clearance for Construction of Proposed Township Project “Nanded City”

capacity is constructed to treat the incoming wastewater. Tertiary treated wastewater is used to fill the lake. This case also elicits the principle of co-funding where multiple stakeholders jointly funded the rejuvenation project.

Key Findings:

Industrial Use

- Cities have multiple options; sale of secondary or tertiary treated sewage or combination of both depending upon the user
- Assured demand by industries both in terms of quality and quantity is essential
- Government funding plays a critical role in catalysing private investment
- Viability gap funding or blended finance model could boost PPP

Municipal Use

- Many municipal (non-potable) uses are under ULBs' control where they can make it mandatory to use recycled water
- States while issuing Environmental Clearance for construction projects, can mandate use of recycled water for construction related activity
- User-based reuse standards are provided in CPHEEO manual 2013, which needs to be revisited

Agriculture

- Key barriers for using recycled water are (i) free electricity offered to farmers for running the tube wells installed at farms individually, (ii) no prohibition in extraction of ground water in states like Punjab, (iii) many regions like Punjab and western parts of Maharashtra have good accessibility to the surface water options for irrigation purpose, (iv) fragmented land holding resulting into smaller and distributed demand and (v) pricing the treated water for agriculture use is difficult.

5.5 Recommendations and Action Plan

While the benefits of wastewater recycling and reuse may be known to different stakeholders, there are very few initiatives and projects on ground. This needs to be addressed through coordinated efforts at national, state and city levels of administration.

Action Plan

Setting Goals for municipal wastewater recycling and reuse

a) Availability of Treated Sewage including potential availability

As per CPCB:

- Total 1,631 STPs (including proposed STPs) with a total capacity of 36,668MLD
- **Sewage generation from urban centres estimated as 72,368 MLD.**
- **Estimated sewage generation: 94,773 MLD by 2036 and 1,20,000 MLD by 2050.**
- Installed treatment capacity (2020): 31,841 MLD and treated quantity: 20,236 MLD

b) Defining Goals

With potential demand of 876billion m³/year in agriculture sector followed by 31 billion m³/year in thermal power plant the goals are set. Other industry may need approximately 4.5 billion m³/year. The short term (2026) target of 25%, mid-term (2036) target of 35% and the long term (2050) target of 50% are set based on the quantity of municipal wastewater generation and potential utilization of sewage (Figure 36). These targets are average percentages for each state to achieve considering the regional diversity, uneven user concentration across regions, and non-uniform availability of treated wastewater across cities/ towns.

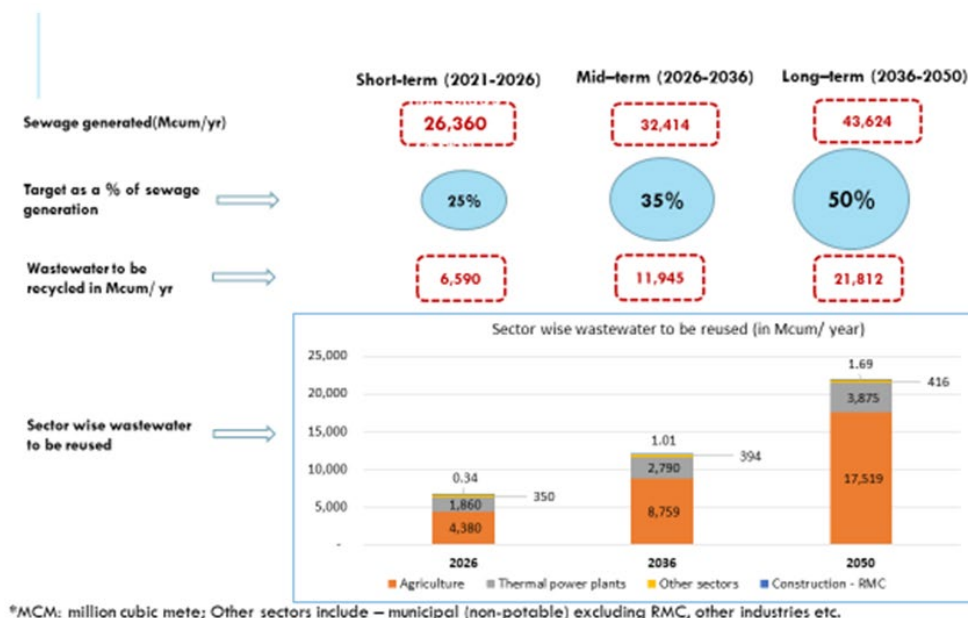

Figure 36: Goals set for Wastewater Recycling & Reuse

Key Actions and Roles of Key Stakeholders

a) Detailed Action Plan

A detailed Action Plan for National/ State / joint initiatives is given in Table 11, Table 12, and Table 13.

Table 11: Detailed Action Plan – National Level

SN	Actions Required	Responsible agencies	Nodal
1	Establish institutional mechanism at national and state level for circular economy in wastewater recycling & reuse.	Ministry of Jal Shakti, MoHUA, Mo Industries, Mo Agriculture,	Ministry of Jal Shakti, MoHUA
2	Preparation of new standards for designated reuse of the treated wastewater and guidelines for the reuse	CPCB, MoEF&CC with experts from institutes like NEERI, IITs	CPCB/ MoEF&CC
3	Assessment of current and future availability of treated sewage , particularly post implementation of SBM.	Ministry of Jal Shakti, SBM cells, CPCB	Ministry of Jal Shakti
5	Formulate a NATIONAL Scheme to promote and finance wastewater recycling & reuse	Ministry of Jal Shakti, MoEF&CC, MoHUA, Ministry of Industries, MoF, MSMEs	--
9	Strengthen existing mechanism for stringent implementation of restricting discharge of polluted wastewater	CPCB, MoEF&CC	CPCB
10	Preparation of technology compendium on wastewater recycling	CPHEEO, NEERI, CPCB	CPHEEO, Ministry of Jal Shakti
9	Preparing safety guidelines for transportation, utilization of treated sewage and promote water safety audits	CPCB, MoEF&CC	--
11	Updating the bidding norms – giving weightage to quality and cost.	State Sewerage Boards, Ministry of Jal Shakti, expert institutions	State Sewerage Boards, Jal Shakti,
12	Tax concession/ incentives to setup STPs, including tax reductions on equipment, policy to be prepared.	MoF, Jalshakti	--
13	Creating PPP mode models for STPs and reuse of treated wastewater in different sectors.	Ministry of Jalshakti, MoHUA, With inputs from experts	--

SN	Actions Required	Responsible agencies	Nodal
14	Research and Development projects in field of innovative methods for reuse/recycle of treated wastewater	CSIR laboratories, DST, DBT, NRF, IITs, NITs	DST, DBT, NRF, CSIR, Private. Enterprises/ business, incubators.
15	Activities for improving acceptability of treated sewage for reuse— prepare and disseminate guidelines and framework for Information, Education and Communication (IEC) Activities	State governments with CPCB, MoEF&CC, reputed NGOs	CSR funds
16	Create a digital platform for treated sewage trade and ecosystem for transportation and supply	State sewerage boards, water supply department, NIC, private partners	State sewerage boards, water supply department,
17	Incorporate/ mainstream the concept of Circular Economy in wastewater recycling & reuse in existing missions such as SBM, Smart City etc. and take up project along that.	Jal Shakti, MoEF&CC, MoHUA,	MoHUA
18	Implementation/ Upgradation of STPs and improve coverage of sewerage network and connectivity in existing STPs to meet the 100% treatment capacity and proper O&M	State Governments/ UTS, ULBs, Sewerage Boards, Jal Shakti (SBM coordinators)	Multilateral, bilateral , Central schemes AMRUT, SMART cities SBM (U&G), other funds,

Table 12: Detailed Action Plan – State Level and including ULBs

SN	Actions Required	Responsible agencies	Nodal
1	Set up a State level Steering Committee on circular economy in municipal wastewater recycling & reuse	State Governments	State Urban Development Dept.
2	Assessment of current and future availability of treated sewage, particularly post implementation of SBM and create a mechanism to routinely update it. Including mapping of sectoral demand	Ministry of Jal Shakti, SBM cells, CPCB, State governments/UTs	Jal Shakti, FY plan of ULBs/States
6	Preparation of State Wastewater Reuse policy including industry specific business models	State Depts. - Industries, Urban Dev., Agriculture	State Urban Development Dept.

SN	Actions Required	Responsible agencies	Nodal
7	Set up a State level Wastewater Recycling & Reuse Fund	State Governments	--
8	Incentives (such as municipal tax benefits) for residential societies with Environmental Clearance and having in-situ STPs with reuse capacity upto 40% of treated wastewater	State / ULBs	--
10	Low hanging fruits —Identify and develop wastewater recycling and reuse projects in pipeline on priority.	State Industries, Urban Dev., Agriculture & Environment depts.	--
11	Align with National policies on updating the bidding norms, digital treated water trade platform, improving coverage of sewerage network, treatment capacities	State Sewerage Boards, water supply department, Ministry of Jal Shakti, expert institutions	State Sewerage Boards, Ministry of Jal Shakti
12	Activities for improving acceptability of treated sewage for reuse— carry out IEC activities.	State governments with CPCB, MoEF&CC, reputed NGOs	SPCB
14	Implementation/ Upgradation of STPs and improve coverage of sewerage network and connectivity in the existing STPs to meet the 100% treatment capacity and do proper O&M.	State Governments/ UTS, ULBs, Sewerage Boards, Ministry of Jal Shakti(SBM coordinators)	Central schemes AMRUT, SMART cities SBM (U&G), other funds,

Table 13: Detailed Action Plan – National and State Level – co-ordinated

SN	Actions Required	Responsible agencies	Nodal
1	Strengthen monitoring of wastewater management system including generation (quality/ quantity), reuse and safe disposal within urban and peri-urban areas by setting up an independent mechanism apart from CPCB and SPCBs.	Ministry of Jal Shakti, MoHUA, State Govts.	CPCB
2	Strengthening capacities of the various intuitions and stakeholders	NEERI State Training Institutes, CPCB	Gol programs
3	Plan national wide campaigns for information dissemination, communications, and educational outreach	Ministry of Jal Shakti, MoHUA, State Govts.	
4	Recognition, awards acknowledging the best performing water reuse projects	Ministry of Jal Shakti, MoEF&CC, MoHUA, State Govts.	

Table 14: Estimates for financial, economic and environmental benefits

Total quantity of untreated sewage	72,000 MLD
Target to reuse treated sewage by 2030	18,000 MLD
Quantity of treated sewage to be sold to industries	4,500 MLD
Revenue generated out of sale of sewage (@20₹/KLD)	9,00,00,000
Total nutrient value per MLD of sewage (tons/day)	0.054 - 0.073
Estimated nutrient value for 18,000 MLD of sewage (tons/day)	3,888 – 5,256
Total economic value of nutrients (minimum) ₹	3,11,04,000
Total economic value of nutrients (maximum) ₹	4,20,48,000
Total number of hectares/ day that can be irrigated with the recovered nutrients	24,923
*Estimated the nutrient potential in wastewater which ranges from 0.054 to 0.073 tonnes MLD-1 (adapted from Minhas 2002; Silva and Scott 2002; CPCB 2009b; WII 2006)	
*Assuming 1 tonne of nutrient load is 8,000 ₹/ton ³⁴	
*One hectare of farmland consumes 156 Kg of fertilizer ³⁵	

Table 15: Estimates for GHG reduction

Potential for treated wastewater irrigation (TWW) ³⁶	2	million hectares
At 25% use	0.5	million hectares
Assuming 50% TWW is used for wheat	0.25	million hectares
At emission rate of 977.15 kg per ha ³⁷	2,44,287.5	tons of CO ₂ equivalent
Assuming 50% of TWW is used for rice	0.25	million hectares
At emission rate of 8447.59 kg per ha	21,11,898	tons of CO ₂ equivalent
Assuming potential reduction in fertilizer use of 20% due to TWW		
Potential reduction in GHGs	4,71,237	tons of CO₂ equivalent
*Projected reduction of 40% in chemical fertilizer use, only 20% considered for conservative estimate		

Key Interventions to implement the action plan

National level interventions

Following policy actions and reforms need to be taken up by the central government in promoting wastewater recycling and reuse:

³⁴ http://www.iwmi.cgiar.org/Publications/wle/rrr/resource_recovery_and_reuse-series_8.pdf

³⁵ http://www.iwmi.cgiar.org/Publications/wle/rrr/resource_recovery_and_reuse-series_8.pdf

³⁶ http://www.iwmi.cgiar.org/Publications/wle/rrr/resource_recovery_and_reuse-series_8.pdf

³⁷ <https://www.ncbi.nlm.nih.gov/pmc/articles/PMC5268357/>

- Develop comprehensive policy and regulations on wastewater recycling & reuse in agriculture, non-potable municipal use and in various industries
- Prioritize, incentivize, and integrate wastewater recycle & reuse in various programs and missions of ministries and earmark funds and monitor implementation
- Constitute an inter-ministerial National Steering Committee – MoEF&CC, MoHUA, MoAFW, MoH&FW, MoF, MoJS, DIPP³⁸. National Steering Committee shall promote and monitor capacity building program and further facilitate infrastructure development for wastewater recycle and reuse in domain of various ministries/ departments like urban, industry, railways, highways, defence etc.
 - integrate principles of circular economy in respective missions/ programs of ministries and prioritise infrastructure development outside urban areas to utilise treated wastewater.
 - Suitable coordination also to be established with the states to facilitate faster clearances from central ministries while laying infrastructure.
- Set up central innovation fund to promote technology development, deployment, and validation along with impetus to entrepreneurship to start-ups.

State level interventions

There is regional diversity in India in terms of geographical settings, availability of water resources, demand- supply scenario and socio-economic fabric.

- Each state needs to have its own wastewater recycling & reuse policy in line with the national policy and guidelines or amend existing policy that could encourage a shift to treated wastewater as an alternate source to freshwater.
- Set up a State Level Cross-sectoral or Cross-agency Committee
- Upgrade and strengthen existing STPs to meet effluent quality for recycle and reuse
- Carry out activities to promote reuse of wastewater and develop the market
- Financing and incentivisation, set up a State Level Wastewater Recycling & Reuse Fund
- Develop a capacity building program on wastewater recycling and reuse for government agencies and private sector-actors on project development, contracting, treatment technologies, monitoring, and O&M needs of wastewater recycling & reuse.

³⁸ The Ministry of Environment, Forest, and Climate Change, Ministry of Housing and Urban Affairs, Ministry of Agriculture and Farmer's Welfare, Ministry of Health & Family Welfare, Ministry of Finance, Ministry of Jal Shakti, Department for Promotion of Industry, and Internal Trade.

In the United States, private industry has traditionally financed industrial water treatment and reuse systems through a combination of commercial loans and corporate bonds, while public water utilities have had access to government subsidized financing through the Clean Water State Revolving Fund (CWSRF).

The 2014 Water Resources Reform and Development Act (WRRDA) allows private companies to obtain CWSRF loans to support onsite industrial water recycling and reuse projects and other privately-owned facilities that reuse or recycle wastewater, storm water, or subsurface drainage water³⁹.

³⁹<https://watereuse.org/wp-content/uploads/2015/01/Industrial-Reuse-CWSRF-WP.pdf>

Chapter 6:

Report of Sub-Committee on Recycle and Reuse of Treated Sludge

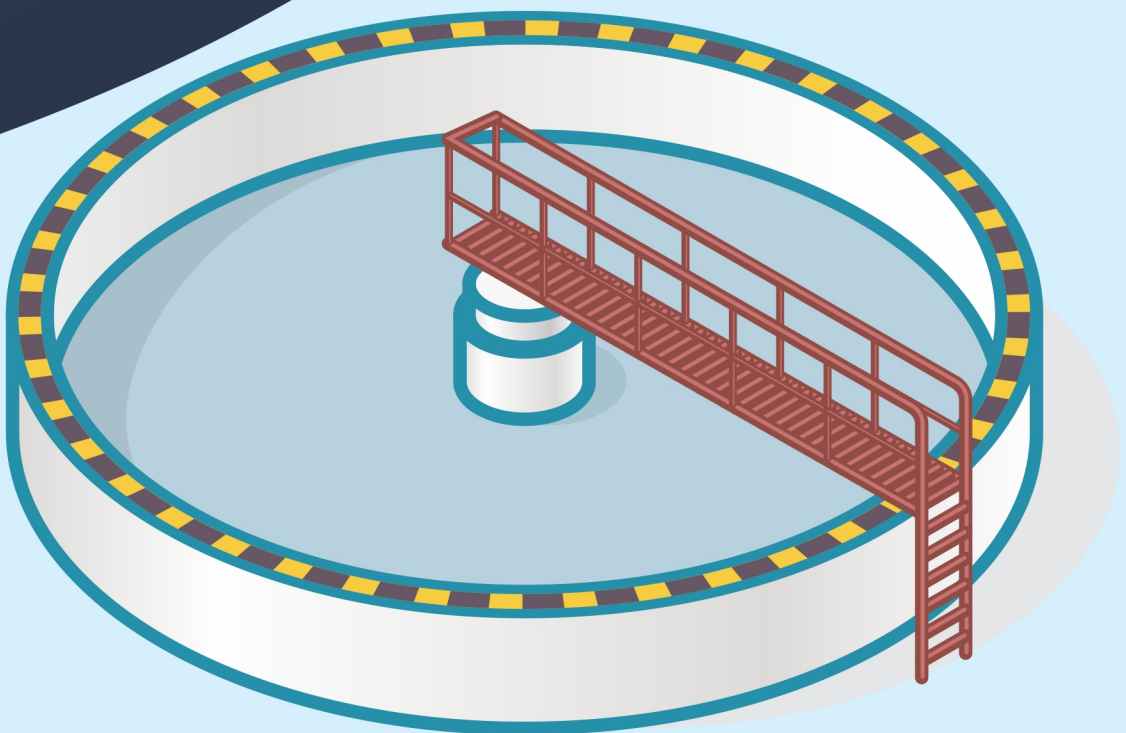

6.1 Introduction

Sludge has for long been viewed as a resource rather than merely as a by-product of liquid waste, since it contains valuable nutrients that promote the growth of crops. Hence, the need of the hour is to develop sustainable sludge management and reuse strategies that are both economically and technically sound and environmentally feasible integrating circular economy principles.

Many countries such as USA and EU member countries are mainstreaming extraction of energy from sludge process and are promoting the concept of circularity in sludge management.

In comparison, sludge utilisation in India is currently being done in an unregulated manner, with little regulatory or eco-system support & standards. In fact, we are yet to recognise and exploit opportunities in sludge & wastewater recycle and reuse. If circular economy principle is mainstreamed in sludge processing and its utilisation, it will result in achieving significant outcomes like improved health, environmental, social, economic benefits etc.

This document will lead to the development of guidance material on successful business models and create an enabling environment for recycle and reuse using innovative technologies.

In the following section, a comprehensive analysis of the current situation of sludge management, gaps in current approach, policies and regulations are given along with recommendations & action plans to mainstream circular economy concepts in planning and implementation.



Figure 37: Composting



Figure 38: 345 MLD Lucknow UASB based STP along with Sludge Drying Bed

6.2 Current Scenario & Challenges

Current Scenario of sludge utilisation

Till recently, there was hardly any formal system for using treated sludge in a beneficial manner in India. Majority of septic tanks were desludged only when they were completely filled up, and often led to choking of the on-site system. Similarly, sludge from STPs were often dumped or used in agricultural fields without any regulation. Currently, around 80% of sludge is being utilised in India.⁴⁰

FSTP's by type of resource recovered in India

- Energy
- Energy & Water
- None
- Nutrients & Water
- Energy & nutrients
- Nutrients
- Energy, water & nutrients

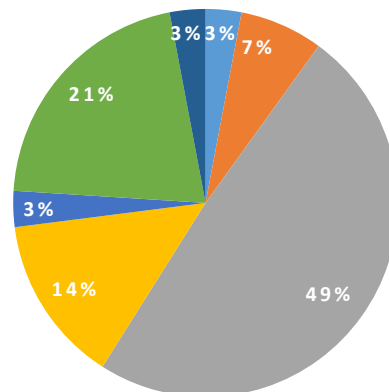

Figure 39: Nutrient/energy recovery from various FSTPs

⁴⁰ Promoting beneficial sewage sludge utilization by ADB

The share of nutrient/energy recovery from various FSTPs in India is shown in the figure 39.

In addition to above, Ministry of Petroleum & Natural Gas has recently launched an initiative titled “Sustainable Alternative Towards Affordable Transportation (SATAT)” aiming at providing compressed biogas (CBG) as an alternative to CNG in automobiles. This initiative has the potential to reduce dependence of country on importing CNG for use in automobiles. This initiative holds great promise for efficient municipal solid waste & sewage sludge management by converting it into compressed biogas (CBG). CBG has the potential to replace CNG in automotive, industrial and commercial uses in the coming years. It is planned to roll out 5,000 CBG plants across India by 2025.



Figure 40: Bio-Gas Plant

However, the focus of MoPNG is presently on those areas which are generating huge biomass such as crop residue etc. and sewage sludge/ solid waste are to pick-up in coming times.

Existing regulatory framework in India

Over the past years, substantial development has taken place in India in the field of waste management and relevant regulatory frameworks have evolved to deal with various types of waste. Moreover, legal instruments, related to environmental pollution, also provide for safe collection and disposal of wastewater and sludge. However, a comprehensive dedicated regulatory framework for recycle and reuse of municipal sludge is yet to evolve in India and is much needed in the present context.

The following section summarises the existing Acts, Policies and Advisories that comprise the current regulatory framework in India.

1. Environment (Protection) Act, 1986

At national level, the **Environment (Protection) Act** was enacted in 1986 (with subsequent amendments) empowering the Central Government to establish authorities charged with the mandate of preventing environmental pollution in all its forms and to tackle specific environmental problems that are peculiar to different parts of the country. Some of the relevant clauses include preventing harm to the environment by restricting discharge of untreated sewage/ environment pollutants, Polluter Pays Principle which emphasizes on collecting user charges for wastewater processing and power to make rules etc.

2. The Environment (Protection) Rules, 1986

These regulations were drawn up by the government under the powers conferred on it in terms of the Environment Protection Act 1986, as discussed above. The first provision of concern to companies and factories is contained in Section 3 which discusses Standards for emissions or discharge of environmental pollutants. It refers to the standards laid down for emission or discharge of environmental pollutants from the industries. **However, there are no specific standards notified for sludge application for agricultural purposes including those for various other by-products.**

3. The Water (Prevention and control of pollution) Act, 1974, amended 1988

The Act was introduced to provide for the prevention and control of water pollution and the maintaining or restoring of wholesomeness of water. The act also prohibits the disposal of polluting matter (as defined by the state pollution control board standards) into streams, wells or sewers or on land. The Act also provides for penalty for those violating the act.

4. The Fertiliser (control) Order, 1985

The order was enacted in 1985 by Ministry of Agriculture and Rural Development which empowers the Central and State Governments for the regulation of fertilisers in the country in respect of grant of permission for production, import and export, price and mixtures of fertilisers. **In schedule IV (Part A & Part B) of this act, characteristics of compost are defined along with the tolerance limits of various parameters in the organic fertilisers, which can act as guiding tool for the reuse of sludge as a bio-fertiliser for land applications.**

5. Hon'ble National Green Tribunal orders

In the recent past, the Hon'ble NGT has often acted as a driving agency for enacting the standards for various wastes. In this regard, Hon'ble NGT has from time to time given its observations and orders for the proper management of sludge and sanitation practices.

- On 17.02.2020, the **Yamuna pollution monitoring committee**, appointed by Hon'ble NGT gave its observations on various methods of sewage and sludge treatment and emphasized on **scheduling of desludging from septic tanks and other treatment facilities**.
- Hon'ble NGT in para no. 16 of its order dated 16.7.2019 in OA no. 916 of 2018 in the matter of Sabha Singh and Others V/s State of Punjab stated that *“The industry shall dispose of its sludge from physio chemical treatment, secondary clarifier sludge and other waste material in an environmentally sound manner, and the industry shall install multi effect evaporator followed by dryer and the dried sludge may be sent to Treatment, Storage and Disposal facility TSDF, Nimbua*

Policy Initiatives

- National Advisory on Septage Management in Urban India
- Manual on Sewerage and Sewage Treatment, 2013 published by CPHEEO, MoHUA. It describes various sludge treatment processes so that it can be reused as a resource material into other forms.
- National Policy on Faecal Sludge and Septage Management (FSSM), 2017
- Advisory on On-Site and Off-Site Sewage Management Practices, 2020

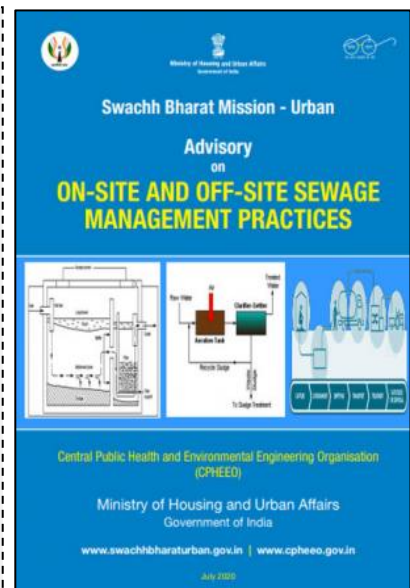

International Practices for Sludge Management and Utilisation

For years, sewage sludge treatment has been considered a secondary issue compared to main wastewater treatment. However, importance of sludge management, is on the rise due to the fast increase of sludge generation owing to sewage network extensions, new installations, and upgrading of facilities. United States, Europe and East Asia are leaders in sludge utilisation.

The practices of sludge management in these countries/areas are briefly mentioned below:

❖ USA

As per United States Environment Protection Agency (USEPA), guidance and regulations are the best way to promote good practices for sludge reuse, recycle and disposal that minimize the potential adverse impacts on public health and the environment and maximize the potential benefits. The benefits potentially gained through sludge use include **energy and nutrient recovery, soil improvement, and conservation of valuable natural resources.**

The American regulations contain very specific directions for sludge treatment before disposal including requirements for pathogens and vector attraction reduction. There were several laws (e.g. **Clean Water Act; Clean Air Act; Resource Conservation and Recovery Act; Marine Protection, Research and Sanctuaries Act; Toxic Substances Control Act; and the National Environmental Policy Act**) which laid emphasis on environmentally sound management of municipal sludge and several of these laws stressed the need for sludge utilization and reuse. Because there was no single legislative approach, a framework for integrating the various Federal laws and regulations was needed to ensure that sludge is used or disposed of in a consistent, environmentally acceptable, and economically feasible manner.

To comprehensively address the issues of sludge management, EPA brought out its final edition part 503 which contains '**Standards for the Use or Disposal of Waste water sludge**' on 25 November 1992. As a result, the sludge utilisation reached to 55 % as per ADB report (2012⁴¹), mostly in form of land application.

In 1977, section 405 of the **Federal Water Pollution Control Act** was amended to add a new section, 405(d), **that required EPA to develop regulations containing guidelines for the use and disposal of sewage sludge on land as well as in water.**

Recognizing the health concern of pathogenic microorganisms in sludge, **USEPA**, based on the level of pathogen reduction, **classified bio-solids into Class A and Class B.**

- In **Class A bio-solids**, the pathogens are below detectable limits: this is achieved by methods such as heat drying, composting, and high-temperature aerobic digestion.

⁴¹<https://www.adb.org/sites/default/files/publication/29785/promoting-sustainable-sewage-utilization-prc.pdf>

- In **Class B bio-solids**, pathogens are present, but the levels are low enough not to pose risk to human health and the environment.



Figure 41: Land Application of sludge

While Class A bio-solids can be bagged and sold, Class B bio-solids can only be used in bulk in controlled sites (e.g. agricultural and forest lands, reclamation sites etc.). For land application of both Class A and Class B bio-solids, all parameters in **Part 503 sludge rule** e.g. vector, pollutant, and management practice requirements have to be met. If the treatment plant's solids will be disposed in municipal solid waste landfills or used as landfill cover material, they must comply with the requirements of 40 CFR 258 (municipal solid waste landfill regulations) rather than with Part 503.

❖ **European Union**

To address the problems of sludge management, European Union came out with waste policy based on the hierarchy of minimisation, recycling, incineration with energy recovery and landfilling.

Using the above hierarchy, EU gives various directives to the Member States for sludge management, as given below:

Directive 91/271/EC Urban Wastewater Treatment:

- In article 14 this directive emphasises that Sludge arising from waste water treatment shall be re-used whenever appropriate. Disposal routes shall minimize the adverse effects on the environment.
- In article 16 it directs Member States to ensure that every two years the relevant authorities or bodies shall publish situation reports on the disposal of urban wastewater and sludge in their areas, and communicated to the Commission.

Directive 86/278/EC

- This directive aims to:
- (a) regulate the agricultural use of sewage sludge by avoiding deleterious effects on soil, vegetation, plants and livestock, and at the same time, and
- (b) promote sound sludge use practices.

❖ Germany

The legal initiatives of Germany can be tabulated as below:

Table 16: Legal initiatives of Germany

Act	Purpose
Act for Promoting Closed Substance Cycle Waste Management	Promotion of closed substance cycle economy, resource protection, environmentally sound waste disposal
Sewage Sludge ordinance	Sludge application to agricultural land (limiting values for quantities, soil, sludge parameters and nutrient demand)
Fertilizer Ordinance/ Ordinance on the Principles of Good Professional Practice During the Application of Fertilizers	
German Federal Soil Protection and Contaminated Sites ordinance	Additionally, for sewage sludge used in landscaping, recultivation and land reclamation
Technical Instructions on Waste from Human Settlements	Landfilling of sludge

The new German Sewage Sludge Regulation requires sewage plant operators to recycle phosphates. Pursuant to the new German Sewage Sludge Regulation in force since 3rd October 2017, sewage sludge must now be recycled to recover phosphorus. The aim is to gradually close the phosphorus cycle and reduce Germany's dependence on phosphorus imports. This will save phosphorus resources and reduce soil contamination.

6.3 Potential for Circularity in Sludge

Approximately 60% of India's population is dependent on on-site sanitation systems, the balance 40% being covered with off-site systems. Sludge is generated from both systems and needs to be managed appropriately, with minimal adverse effects on the environment. However, in contrast to on-site sludge, sludge from off-site systems might contain heavy metals, industrial waste, kitchen waste, runoff, emerging contaminants etc. that would require special attention while using the treated sludge.

As per the CPCB report on National Inventory of Sewage Treatment Plants (2021),⁴² sewage generation from urban centres is about 72,368 MLD. The total sludge potential in the country is approximately 18,000 tonnes per day. This estimated quantity of sludge contains phosphorous, potassium, nitrogen & carbon which are vital for crops/plants. After removal of pathogens and other pollutants, this can be beneficially utilised and promote circular economy. It is estimated that out of sludge recycle & reuse, annual return will be of order of ₹6,700 crore due to the generation of 82.5 Lakh cubic meter of biogas and 3,600 metric tonne of compost per day. It will also save an estimated land area of approximately 450 acres costing about ₹350 Crores.

It is also estimated to generate employment @ 5,000 persons per year. The estimated return involving circularity in sludge management is given at **Annexure 5.1**. A case study of Chennai is given at **Annexure 5.2**.

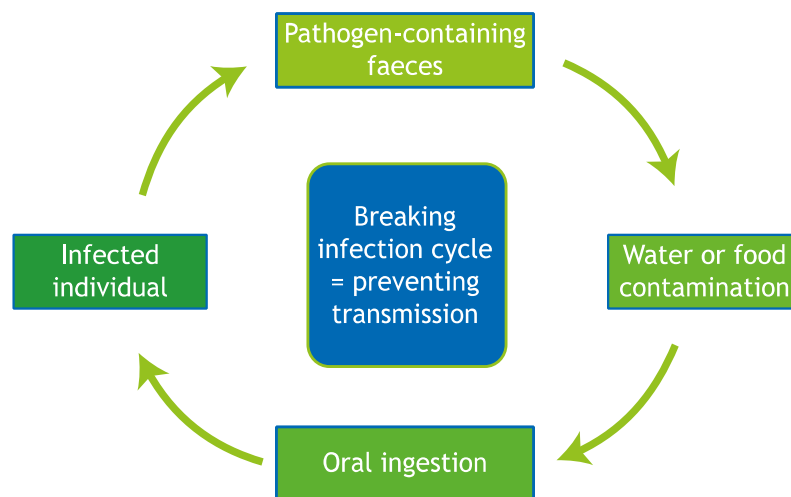

Figure 42: Faecal-oral transmission of pathogen

As per MoEF&CC's India Second Biennial Update Report to the United Nations Framework Convention on Climate Change, emissions from domestic and commercial

⁴²<https://cpcb.nic.in/openpdf.php?id=UmVwb3J0RmlsZXMvMTlyOF8xNjE1MTk2MzlyX21lZGlhcGhvdG85NTY0LnBkZg==>

wastewater treatment and disposal were 366 Lakh tonne of CO₂ in 2014⁴³. Thus, scientific treatment of sludge is expected to result in saving of 400 Lakh tonne of CO₂.

6.4 Gaps & Challenges in Current Approach

With the implementation of circular economy, it is important to evaluate constituents that may impact both humans and the environment. On the basis of analysis of the different approaches in different countries, some gaps and issues in India have been identified, as given below:

- i. MoPNG is presently considering huge biomass resources such as crop residue, cow dung etc. Thus, its lack of focus on sewage sludge/solid waste represents a gap in current scenario.
- ii. Social stigma towards by-products of sludge treatment is also a major issue, due to which there is a lack of market to sell the treated sludge.
- iii. Lack of intra-country studies on various pollutant transfers in the soils when the sludge is applied on agricultural lands and appropriate application rates of sludge creates aversion among farmers to dispose the fully or partially treated sludge in their lands.
- iv. Lack of research in enriching the by-products with additional nutrients by adding other wastes and microorganisms in the products, so that they are viewed as replacement for chemical fertilizers.
- v. Absence of successful case studies or successful business models within the country makes the sludge treatment a lesser preferred option by stakeholders as there is no guarantee for payback.
- vi. There is no proper accounting and monitoring of sludge from small scale decentralised STPs, which makes it absent from the National/ States' radar.

Gaps in regulations & policy

- i. **Lack of dedicated standards on discharge of sewage sludge, recycle and reuse:** Though various guidelines/standards have been brought out by the Centre and State Governments regarding waste disposal in the past, there are no dedicated

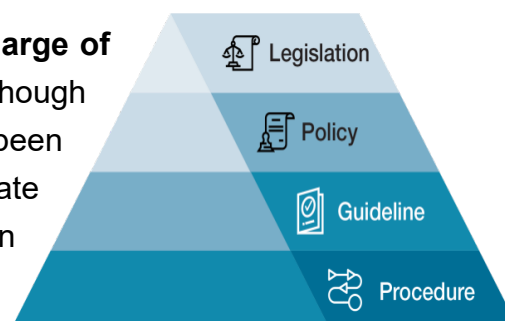

⁴³<https://moef.gov.in/wp-content/uploads/2019/04/India-Second-Biennial-Update-Report-to-the-United-Nations-Framework-Convention-on-Climate-Change.pdf>

- comprehensive discharge standards for sewage sludge.
- ii. **Lack of dedicated quality standards for treated sludge in Fertilizer Control Order:** Maximum limits in respect of various contaminants in organic compost had been prescribed in the subsequent amendments of Fertilizer (control) Order, 1985. However, the order does not have any dedicated standards for treated sludge to be used as manure as the nature and concentration of contaminants vary widely in sewage sludge when compared to other wastes.
 - iii. **Lack of guidelines or standards for alternative uses of treated faecal sludge:** There are no guidelines/standards for various treatment/disposal options for sludge such as alternative fuel in cement industry, thermal processing etc.
 - iv. **Lack of integrated policy for treatment and reuse of faecal sludge:** No comprehensive policy exists currently for the collection, conveyance, treatment, recycle and reuse of sludge, except for that of the faecal sludge.
 - v. **Lack of integrated user charges for sewage and sludge management:** Although sludge accounts for only 1-2 % of sewage volume, the cost of treatment of sludge accounts for approximately 20-60 % of wastewater treatment cost. However, the current user charges collected by the ULBs are at older rates and does not account for the sludge treatment costs.
 - vi. **Lack of monitoring framework on recycle and reuse of sludge:** There is no regulatory framework in the country that considers risk associated with the recycle and reuse of municipal sludge including *rigorous and continuous monitoring*.
 - vii. **Lack of Market based incentives for sewage sludge:** Subsidy/Market Development Assistance, as in case of city compost, does not exist in case of sewage sludge.
 - viii. **Lack of mandatory sale of sewage sludge products:** There is no obligatory framework for fertilizer companies to sell/buy the by-products out of sludge management.
 - ix. **Lack of standard guidelines on reuse of sludge:** Standards /guidelines for reusing sludge as a fuel needs to be developed so that the carbon foot print of industries can be reduced.
 - x. **Lack of national policy on sewage sludge management policy:** Unlike the NPDES programme in USA, there is an absence of any national level sewage sludge management policy, program, circular economy model or regulation to enhance resource efficiency for treated sludge reuse and recycling.
 - xi. **Absence of Penalizing mechanisms:** penalty clause for strict enforcement action including fine against a person or wastewater treatment plant (WWTP)

manager who does not meet the requirements of reuse or recycling of sludge is also missing currently.

- xii. **Lack of SLB for Sludge recycling and reuse:** Like in case of wastewater targets there is no Service Level Benchmark (SLB) for the recycling and reuse of sludge for placing the component in forefront.
- xiii. **Lack of tax benefits:** There is no GST exemptions or tax holidays for sludge recycle and reuse.

6.5 Technology Options

There are many proven technologies to treat sludge vis-à-vis composting, hygienisation, thickening, dewatering, incineration, gasification, pyrolysis etc. given in the Manual of Sewerage & Sewage Treatment Systems, 2013 published by Ministry.

6.6 Recommendations and Action Plans

Based on analysis of current situation of sludge processing, recycling and reuse, as mentioned in the foregoing sections, the gaps in the existing system, viz. regulatory framework and policy are already identified. Recommendations against identified gaps and action plans are given in the table below. The table maps all recommendations/ actionable points, categorized at National level, State/ UT level and ULB level, along with the responsibilities of relevant stakeholders to achieve desired objectives of sludge recycling/reuse in the spirit of circular economy. The interventions are further categorized as: a) regulations, and b) enablers.



Figure 43: Sludge Drying Bed

Table 17: Actionable points for Recycle and Reuse of Treated Sludge

S.N	Actionable points	Stakeholders	Responsibilities
National Level Regulations			
1.	Policy on sludge reuse/recycle	MoHUA/ CPHEEO, MoJS	<ul style="list-style-type: none"> MoHUA to prepare national policy including rural perspective and urban-rural linkages to achieve scale of economy
2.	Comprehensive standards on recycle and reuse of processed sludge	MoA&FW, MoEF&CC/ CPCB, MoHUA/ CPHEEO, MoJS	<ul style="list-style-type: none"> MoA&FW to incorporate standards for compost out of treated sludge in FCO 1985 for usage in different types of edible/non-edible crops/agroforestry, etc. MoEF&CC/ CPCB to develop standards for sludge/septage for application on land MoHUA/ MoJS to provide inputs from rural perspective MoPNG to develop standards/ buying of biogas
3.	Extraction of phosphorous at STPs	CPHEEO, MoHUA, CPCB, MoJS	<ul style="list-style-type: none"> MoHUA to provide technological guidance MoEF&CC/CPCB to develop standards
National level enablers			
1.	Convergence of stakeholders	MoHUA, MoA&FW, MoJS, MoP& NG, MoP	<ul style="list-style-type: none"> For convergence of policy and program, a High Power Committee under chairmanship of Secretary/Additional Secretary may be set up
2.	Centre of Excellence	Research Institutes, Universities	<ul style="list-style-type: none"> One premier technical institute and agricultural institute maybe recognized as centre of excellence

3.	Capacity building at State/ULB	CPHEEO, SUDD	<ul style="list-style-type: none"> • Develop course curriculum on capacity building of various stakeholders
4.	Customs/GST exemption on equipment	Ministry of Finance & Expenditure	<ul style="list-style-type: none"> • MoF to exempt Custom/GST on use of plants/ machinery to make biogas, to electricity plants and sludge dewatering equipment (screw press, etc.)
5.	Incentivise by-products and tag sale with chemical fertilizers	Ministry of Chemicals & Fertilizers	<ul style="list-style-type: none"> • MoC&F to extend MDA for city compost to compost produced out of sludge • MoC&F tag sale of compost out of sludge with chemical fertilizers
6.	Incentivise biogas generated out of sludge	MoPNG	<ul style="list-style-type: none"> • MoPNG to incentivise through a mechanism buying of biogas produced out of Sludge. For STPs with capacity < 50 MLD set up plant for biogas generation on cluster basis
7.	Inventorization of STPs by CPCB	CPCB	<ul style="list-style-type: none"> • CPCB while inventorizing STPs also to collect data on sludge processing plants & it's end use
State Level Regulations			
1.	Policy on Sludge Recycle & Reuse	SUDD	<ul style="list-style-type: none"> • State specific sludge recycle & reuse policy to promote its circularity
2.	Tax/fine on dumping sludge in landfills/open land	SUDD SPCB	<ul style="list-style-type: none"> • SPCB to impose heavy fine/Tax on indiscriminate dumping of sludge
3.	State strategy on recycle and reuse of sludge	SUDD	<ul style="list-style-type: none"> • SUDD to develop suitable strategy to achieve the policy objectives of recycle & reuse of treated sludge
State Level Enablers			
1.	Designating Nodal Department	SUDD,	<ul style="list-style-type: none"> • State UD may be designated as nodal department to coordinate

		Agricultural, SPCB	with other departments through a high-level committee
2.	Retrofitting of STPs with Sludge Recycling Facility	SUDD/PHED/Water Supply & Drainage Boards	<ul style="list-style-type: none"> All new STPs to mandatorily have sludge recycle and reuse facility Existing STPs will be retrofitted to treat the sludge
3.	Compost Testing facilities and Labs	NABL,SPCB, SUDD	<ul style="list-style-type: none"> State agricultural department/UD department promote developing compost testing facilities
4.	Capacity building & dissemination of best practices	SUDD	<ul style="list-style-type: none"> Suitable capacity building and training of personnel engaged in sludge management at State/ULB level National and international successful models need to be disseminated to ULBs
5.	Awareness creation	SUDD	<ul style="list-style-type: none"> Effective strategy for awareness creation on reuse of by-products out of sludge to public

ULB Level Regulations

1.	Tax on dumping sludge in landfills	Urban Local Body	<ul style="list-style-type: none"> ULB to notify fee/ tax on dumping of sludge in landfill for plant operators/desludging operators
----	---	------------------	--

ULB Level Enablers

1.	Retrofitting STPs with Sludge Recycling Facility	Urban Local Body	<ul style="list-style-type: none"> ULB need to retrofit STPs with Sludge Recycling facilities adopting principle of circular economy
2.	Awareness creation	Urban Local Body	<ul style="list-style-type: none"> Effective strategy for awareness creation on reuse of by-products out of sludge

Chapter 7: Conclusion and Recommendations



Conclusion

In recent years, the concept of circular economy has gained increasing prominence across the world as an approach that presents solutions to some of the world's most pressing sustainable development challenges⁴⁴, including that of waste management. In circular economy, waste and pollution are minimised by design; products and materials have a longer life cycle; and natural systems are regenerated using a 3R (Reduce, Reuse, Recycle) approach. This is becoming an increasingly popular strategy to accelerate implementation of the SDG 2030 Agenda.

The introduction of Swachh Bharat Mission, rooted in the 3R principles, was a major step in this direction, where, for the first time, the issue of waste management on a Mission mode was brought to the centre of the nation's development agenda. Parallely, the promulgation of the SWM Rules 2016, Plastic Waste Management Rules 2016, 2018, National Fecal Sludge and Septage Management Policy 2017 etc. have helped to further strengthen this focus and realign the country's commitment to a greener environment and zero-waste future.

Over the last few years, a number of good practices in reuse of Solid and Liquid waste to value added products have emerged, both in India and abroad. However, in the absence of a conducive eco-system comprising of a strong regulatory framework, structured process of knowledge transfer, and adequate participation from private sector and citizens, such good practices have remained as islands of excellence, rather than being scaled up and mainstreamed to become an accepted norm. Clearly, despite significant success having been achieved in India in the area of Solid and Liquid waste management, a lot more remains to be done, especially if circular economy in waste management has to be institutionalized as a practice.

In this backdrop, NITI Aayog had identified 11 EoL products/ recyclable material / wastes that pose considerable challenges and need to be addressed holistically through a comprehensive circular economy framework. This report, which forms part of a larger document on '*Transitioning from a Linear to Circular Economy: An Impetus for India's AatmaNirbhar Bharat Abhiyan*' by NITI Aayog, has looked at the Municipal Solid and Liquid Waste component. Within Municipal Solid Waste, the potential for circularity has been examined for three sub-categories of waste, viz. (i) Dry waste, (ii) Wet waste, (ii) Construction & Demolition waste. For Municipal Liquid waste, the report has looked at two sub-categories, viz. (iv) Wastewater, and (v) Municipal Sludge. Specifically, the report has attempted to identify and recommend financially viable and

⁴⁴ https://www.un.org/en/ga/second/73/jm_conceptnote.pdf

sustainable business models for reusing solid and liquid waste (across these 5 categories) and thus create an enabling environment for circular economy to thrive.

Recommendations

For each of the 5 waste sub-categories of Municipal Solid and Liquid waste, the report has come out with some key recommendations & action plans – for both national & State/ UT levels - for maximising the circular economy potential in the sector.

Some of the key recommendations on Municipal Solid and Liquid waste include:

- Strengthening of existing policies & regulations integrating circular economy principles in implementation of programs/ schemes/ projects.
- Promoting innovations & research to accelerate pace of circularity in processes.
- Promoting priority lending to private/ public sector to attract higher investment in waste management sector.
- Reduction of GST on recycled products to 5% to make them competitive with virgin materials.
- Fee-based landfilling of waste products

In addition to the above, some category wise recommendations are summarised as follows:

1: Dry Waste

1a) Key recommendations

- Inclusion of dry-waste streams in the ambit of Extended Producer Responsibility (EPRs): Paper, Textile, Rubber, Metals and Glass etc. in alignment with 'polluter pays' principle.
- Mandating use of 25% recycled materials in the non-food grade packaging to ensure uptake of recycled materials.
- Mandating that cement kilns use 25% RDF (non-recyclable combustible dry waste) to replace coal
- Mandating use of mono-polymers in the production of the packaging products. e.g., PET bottles with HDPE cover/ cap and PPP films avoided, to enhance recycling

1b) Estimated benefits from circularity

Material recycling facilities can play a significant role in ensuring circularity in dry waste management. If implemented, material recycling facilities can help

improve recovery from ₹5,187 crores/ annum to ₹17,023 crores/ annum by 2025, thus adding ₹11,836 crores to the economy annually. MRFs will also help to generate employment of 40 Lakh person-days during construction, and ~80 Lakh person-days in perpetuity for operations & maintenance of these facilities.

2: Wet Waste

2a) Key recommendations

- Unbundling SLF from SWM functions
- Relaxing environmental clearance (EC) for setting up waste processing plants
- Incentivizing biogas plants
- Incentivizing by-products and tag sale with chemical fertilizers

2b) Estimated benefits from circularity

- Net additional contribution to economy is estimated at ₹2,460 crores per annum if 50% wet waste is processed by bio-methanation in urban India.
- Employment generation of about 1 crore man-days is estimated during construction and about 60 lakh man-days for O&M, in perpetuity.

3: Construction & Demolition Waste

3a) Key recommendations

- Reducing virgin material use, e.g. use of 20% secondary materials in new building construction, 40% in Roads & Highways.
- Providing tax rebates to building products & materials with secondary resources
- Buy-back of recycled material from processing plants through building permit system by ULBs.
- Exemption of Green tax on C&D Recycled products and transportation, wherever applicable
- Mandating a threshold level proportion of C&D waste use in all public and private buildings/ infrastructure

3b) Estimated benefits from circularity

Realizing potential of C&D waste value chains through Circular Economy is expected to lead to revenue of ₹416 crore per year along with generating employment for around 10,000 persons per day.

4: Wastewater

4a) Key recommendations

- Establishing institutional mechanism at national and state level for circular economy in wastewater recycling & reuse
- Preparation of new standards for designated reuse of the treated wastewater and guidelines for the reuse
- Preparation of State Wastewater Reuse policy including industry specific business models
- Creating PPP mode business models for STPs and reuse of treated wastewater in different sectors.
- Mandating use of recycled water in thermal power plants located within 50 km of ULB

4b) Estimated benefits from circularity

The sale of treated sewage has potential to generate revenue of ₹3,285 crore per year in India. Additionally, nearly 5,400 people can be directly employed in operation and maintenance of treatment infrastructure assuming 25% of treated sewage is reused.

5: Municipal sludge

5a) Key recommendations

- Introducing national policy on sludge reuse/ recycle
- Introducing comprehensive standards on recycle & reuse of processed sludge
- Incentivising by-products and tagging sale with chemical fertilizers
- Incentivising biogas generated out of sludge
- Imposing tax/ fine on dumping sludge in landfills/open land

5b) Estimated benefits from circularity

The annual return from sludge recycle & reuse is estimated to be in the order of ₹6700 Crore through utilization of 82.5 lakh cubic meter of gas and 3600 metric tonne of compost per day. This is also expected to save an estimated land area of approximately 450 acres costing about ₹350 crores.

The initial steps have been taken in integrating circular economy approach to waste management. The need of the hour now is to mainstream the principles of circular economy into the entire waste management value chain. A multi-pronged approach is recommended for this, which would include: (i) strengthened regulatory framework, (ii)

expanded scope of existing waste management policies along with strict enforcement mechanism for compliance, (iii) creation of a conducive environment for encouraging private sector participation and citizen engagement, and (iv) awareness generation among citizens, along with capacity building of all stakeholders, in order to maximise the benefits of circular economy and make it a way of life.

The image features a light blue background with several curved, overlapping bands of color. A large, dark blue curved shape dominates the upper left and center. Below it, a bright green band curves across the middle. Further down, a dark blue band follows the curve. At the bottom, another bright green band is visible, followed by a dark blue band. The word "Annexures" is written in white, bold, sans-serif font on the dark blue band in the upper left.

Annexures

Annexure 1: Circular Economy for Dry Waste

Annexure – 1.1

Tentative Gross Economic Benefits of MRFs (in Urban India)

	2021 ²	2025 ³
Dry Waste Generation in TPD ¹	47,850	67,650
Quantum of Materials Recovered at MRFs in TPD ⁴	24,945	50,231
Estimate of Cost Recovered /day Rs in Crores	14.21	46.64
Estimated Cost Recovered per annum ₹ in Crores	5,187	17,023
Net Benefit after incorporating CE principles is ₹11,836 Crores per annum		

Note:

1. Dry waste generation taken as 33% (132gms/capita) of the total waste generated (400gms/capita)
2. Current Scenario with available MRF Facilities
3. Scenario after incorporating CE principles
4. The quantum of materials recovered from MRF and details of their fractions are captured in next page.

An additional revenue of ₹11,836 Crores per annum can be added to the economy through installation of Material Recovery Facilities in line with the Principle of Circularity for total dry waste generation of 67,650 TPD

Employment Generation

Capacity of Material Recovery Facilities to be installed (2025)	67,650	TPD
Personnel Required for construction of MRF Manual/Hybrid (@25 persons/100TPD)	16,912	Nos
Number of Days (Duration of Construction 8 Months)	240	Days
Number of Person-days	40,59,000	Person-Days
Say 0.4 Crore person-days during the Construction Phase		
Capacity of Material Recovery Facilities to be installed (2025)	67,650	TPD
Personnel Required for O&M (@31 persons/100TPD)	20,971	Nos
Number of Days	365	Days
Number of Person-days/Annum	76,54,415	Person-Days
Say 0.8 Crore person-days in perpetuity for O&M		

Current Scenario of Dry Waste (2021)

S No	WASTE	TOTAL WASTE GENERATED DAILY (TPD)	CONTENT IN MSW, %	DAILY GENERATION, TPD	CURRENT RECOVERY, %	QTY RECOVERED, TPD	CURRENT VALUE, RUPEES PER MT	VALUE RECOVERED DAILY, ₹ in Crore
1	Plastic	145,000	15%	21,750	60%	13,050	6,000	7.83
2	Paper & cardboard		7%	10,150	60%	6,090	6,000	3.65
3	Glass & Ceramics		1%	1,450	20%	290	4,000	0.12
4	Metal		1%	1,450	50%	725	5,000	0.36
5	Textiles		5%	7,250	30%	2,175	4,000	0.87
6	Tyres & Rubber		1%	1,450	80%	1,160	6,000	0.70
7	Others (Human Hair, Coconut, Tetrapack, Footwear)		3%	4,360.15	33%	1,455.08	4,700	0.68
	TOTAL		33%	47,860.15		24,945.08		14.21

Per Annum 5,187.52

Scenario after implementation of Circular Economy Principles (2025)

S No	WASTE	TOTAL WASTE GENERATED DAILY (TPD)	CONTENT IN MSW, %	DAILY GENERATION, TPD	CE RECOVERY, %	QTY RECOVERED, TPD	CE VALUE, RUPEES PER MT	VALUE RECOVERED DAILY, ₹ in Crores
1	Plastic	205,000	15%	30,750	80%	24,600	10,000	24.60
2	Paper & cardboard		7%	14,350	80%	11,480	10,000	11.48
3	Glass & Ceramics		1%	2,050	50%	1,025	10,000	1.03
4	Metal		1%	2,050	80%	1,640	10,000	1.64
5	Textiles		5%	10,250	60%	6,150	5,000	3.08
6	Tyres & Rubber		1%	2,050	80%	1,640	10,000	1.64
7	Others (Human Hair, Coconut, Tetrapack, Footwear)		3%	6,150	60%	3,696.15	8,600	3.18
	TOTAL		33%	67,650		50,231.15		46.64

Per Annum 17,023.12

Annexure – 1.2

Material Recovery Facility

Material Recovery Facilities are the foundation for resource recovery and recycling. These facilities follow the sustainable hierarchy of waste management i.e., collection of source segregated waste, classification of dry waste into different categories (paper, cardboard, plastics of all types, glass, metal etc.) and also depending on their commercial usage and value. The segregated waste is a ready raw material for scrap dealers, recyclers and industries where these may serve as input materials. Depending on the scale of operations, type of operations and the level of mechanization in the facility, MRFs may be classified in three categories⁴⁵:

- **Manual:** In manual MRFs, sorting process is carried out manually. This type of MRFs are suitable for small quantities of MSW like 5-10 TPD only and are suited for cities with population less than 1 Lakh.
- **Semiautomatic:** This type of Material Recovery Facilities has combination of manual and mechanized operations. Semi-automated MRF can cater for 10- 100 TPD of segregated waste and are suited for cities with population of 1 Lakh – 10 Lakh.
- **Automatic:** Mechanized material recovery facilities are fully mechanized/ automated facilities for material recovery in large quantities (>100 TPD) with least human intervention. These facilities are best suitable for segregation of recyclables/ non-recyclables/ RDF/ inert for cities with population more than 10 Lakhs, when only source segregated dry waste is coming to the facility.



Figure: Mechanized material recovery facilities

Mechanical Recycling

It refers to the processing of waste into secondary raw material or products without changing the chemical structure using mechanical processes (i.e. grinding, washing, separating, drying, re-granulating and compounding). As part of mechanical recycling, material is melted and extruded into the form of pellets which are then used to manufacture other products.

⁴⁵ Advisory on Material Recovery Facility (MRF) for Municipal Solid Waste, MoHUA, June 2020

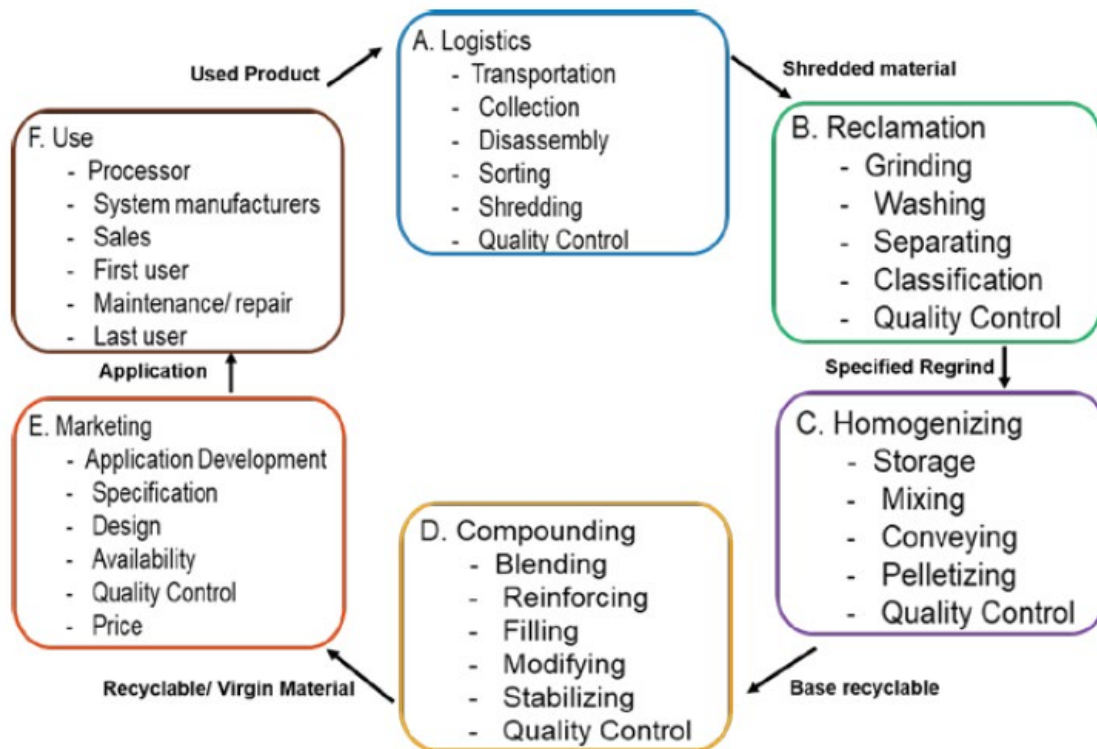

Figure: Mechanical Recycling

Refuse-Derived Fuel (RDF) for Co-processing

RDF typically consists of the residual dry combustible fraction of the MSW including paper, textile, rags, leather, rubber, non-recyclable plastic, jute, multi-layered packaging and other compound packaging, thermocol, coconut shells etc. Co-processing refers to use of waste materials in industrial processes (cement and thermal power stations etc.) as alternative fuels or raw material to recover energy and material from them. It is a sustainable method of waste disposal as compared to land filling and incineration because of reduced emissions.

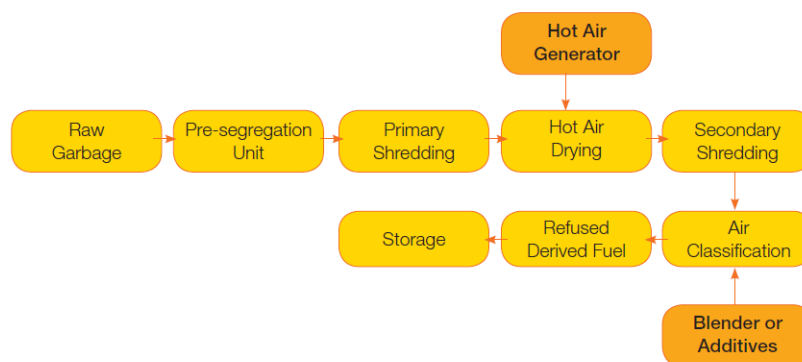

Figure: RDF Generation

Plastic to Road Construction

The implementation of plastics in roads opens a new option for recycling post-consumer plastics. The types of plastic that can be used for construction of roads are Polystyrene (PS) (Hard packaging, cartons, plates, vending cups etc.); Polypropylene (PP) (ketchup bottles, yogurt cups etc.); Polyethylene (PE) (both high and low density) (plastic bags, water bottle, shampoo bottle etc.). Poly Vinyl Chloride (PVC) sheets or Flux sheets should not be used. The Ministry of Road Transport & Highways, Government of India has made it mandatory for road developers to use waste plastic along with bituminous mixes for road construction to overcome the problem of disposal of plastic waste in India's urban centres⁴⁶.

Table: Cost Comparison between Plain bitumen road & Plastic Bitumen Road⁴⁷

Sr. No.	Material Needed	Plain Bitumen Process	Plastic Bitumen Road
1	Road Construction Cost	₹21.00 lakhs	₹18.90 lakhs
2	Maintenance Cost @Rs./ km per year	₹14,000 per km year for rural roads. Thus, for five years, ₹70,000	No Maintenance cost for a minimum of five years; Maintenance not needed up to 10 years
3	Road Renewal Cost	Roads renewed after 5 years costing ₹3.5 lakhs	Nil
4	Total Cost for minimum service of five years	₹25.2 lakhs	₹18.9 lakhs
5	Use of Waste Plastics	Nil	One tonne per km

Pyrolysis

Pyrolysis uses heat to break down combustible polymeric materials in the absence of oxygen, producing a mixture of combustible gases liquids and solid residues. The products of pyrolysis process are: (i) a gas mixture; (ii) a liquid (bio-oil/tar); (iii) a solid residue (carbon black). The proportion and composition of the various fractions depends on a variety of parameters. Two technologies exist and differ on the method of heat transfer: fast pyrolysis for production of bio-oil and slow pyrolysis for production of charcoal called carbon black.

⁴⁶ Plastic Waste Management Issues, Solutions & Case Studies, MoHUA, March 2019

⁴⁷ Plastic Waste Management Issues, Solutions & Case Studies, MoHUA, March 2019

Table: Process details of conversion technologies⁴⁸

Conversion Process	Air (or steam) supply	Temp (°C)	Products
Gasification	Less than stoichiometric oxygen required	800-1200	Heat, Syngas fuel, Char
Incineration	In excess	800-1200	Heat
Pyrolysis	Total absence	300-600	Heat, fuel oil, Combustible Gas, Char

Gasification

Gasification is the partial combustion of organic or fossil based carbonaceous material, plastics, etc. into carbon monoxide, hydrogen, carbon dioxide, and methane. This is achieved at high temperature (650°C and above), with controlled amount of air, oxygen, or steam. The process is largely exothermic, and the main product is syngas, which contains carbon monoxide, hydrogen, and methane. The other main product is a solid residue of non-combustible material (ash).

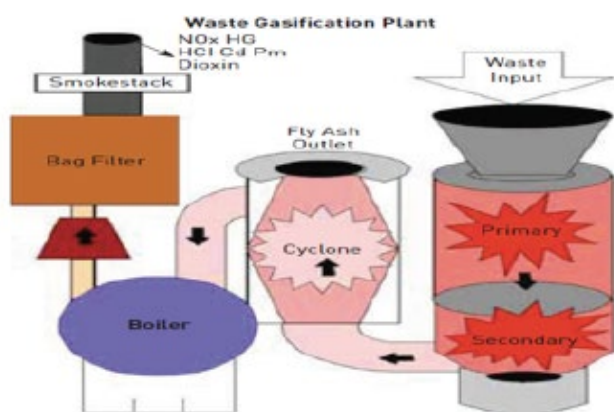

Figure: Gasification

Waste Incineration

Waste incineration, or controlled burning, is a disposal method that involves combustion of waste at very high temperatures in the presence of oxygen and results in the production of ash, flue gas, and heat.

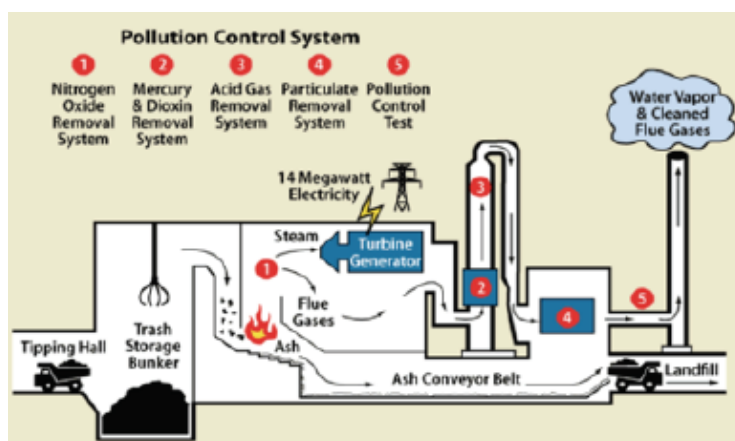

Figure: Waste Incineration

⁴⁸ Report of the Task Force on Waste to Energy (Volume I), May 2014

Annexure 2: Circular Economy for Wet Waste

Annexure – 2.1

Tentative Gross Economic Benefits of Bio-methanation (in Urban India)

Year	2021	2025
Wet waste Generation ¹ (TPD)	72,500	1,02,500
Biomethanation plants (setup)(TPD)	2,300 ² (MIS, Actual)	51,250
Development TARGET %(for CE)	3%	50% ³
Potential Gas Generation @ 3% CBG	69	1,538
Gas Generated , in MMTPA	0.025	0.561
Estimated Revenue Generation @ ₹46.00/kg (₹in Crores)	115.85	2,581.46
Net Contribution to the Economy	₹ 2,460 Crores	

Note:

- Wet Waste Generation taken as 50% (200gms/capita) of the total waste generated (400gms/capita)
- Present capacity of Biomethanation Plants as per MIS of SBM (Urban).
- Under Circular Economy initiative 50% of wet waste processing by Biomethanation by 2025 can be aimed in a dedicated mission

From the above it may be seen that the Wet Waste processing by **Biomethanation** can contribute about **₹2, 460 Crores** additionally to the Economy by 2025 (Per Annum)

Employment Generation Potential

Capacity of Biomethanation Plants to be installed (2025)	51,250	TPD
Manpower Required for construction (@35 persons/ 100TPD)	17,938	Nos
Number of Days (Duration of Construction 18 Months)	547	Days
Number of Man-days	98,11,813	Man-Days
Say 1.00 Crore man-days during the Construction Phase		
Capacity of Bio-methanation Plants to be installed (2025)	51,250	TPD
Manpower Required for O&M (@31 persons/ 100TPD)	15,888	Nos
Number of Days	365	Days
Number of Man-days/Annum	57,98,938	Man-Days
Say 60 lakh man-days in perpetuity for O&M		

Bio-methanation Processing targeting higher capacities for processing Wet Waste under Circular Economy initiatives can generate about **1.00 Crore man-days** during construction phase and about **60 lakh man-days** in perpetuity for O&M

Annexure – 2.2

Biomethanation CNG Plant Feasibility Matrix based on Indore 20 TPD Plant

S.No.	Particulars	25 TPD	50 TPD	100TPD	200 TPD	500TPD
1	Input quantity of WET waste in Tonnes per day	25	50	100	200	500
2	Estimated Capital cost in ₹ in Lakh	1,200	2,000	3,500	6,000	12,000
3	Regular O&M (per month) ₹Lakh	5	8	12.50	20	40
4	Special O&M (per month) ₹ in Lakh	1.25	2	3.25	5	10
E	TOTAL Expenses (per month)	6.25	10.00	15.75	25.00	50.00
5	CBG output in Kg per day @ 40kg/ TPD of waste	1,000	2,000	4,000	8,000	20,000
6	Revenue from sale of CBG (per month) (generation x 30 x ₹46 of SATAT) ₹ in Lakh	13.80	27.60	55.20	110.40	276
7	Compost production 15% of input in TPD per day	3.75	7.5	15	30	75
8	Revenue from sale of Compost @ 2000/T (per month) ₹ in Lakh	2.25	4.50	9	18	45
R	TOTAL Revenues (per month) ₹ in Lakh	12.60	25.20	50.40	100.80	252
9	NET - Revenue - Expenses (per month) ₹ in Lakh	9.80	22.10	48.45	103.40	271
10	Breakeven in months	122	90	72	58	44
11	Breakeven in years	10	8	6	5	4
12	Model proposed	EPC with O&M of 10 years	EPC with O&M of 10 years	25% VGF with O&M of 15 years	PPP with O&M of minimum 20 years	PPP mode with O&M of minimum 20 years

Annexure – 2.3

Decentralized High rate Biomethanation Systems CSIR-IICT Hyderabad

Quantity of Organic waste (kg/day)	Food print area required for plant installation (m ²)	Power consumption (kWh)	Average Biogas and bio manure generation per day		Equivalent LPG replacement (Kg/day)	Revenue due to LPG (₹ per annum)	Revenue due to sale of bio manure (₹ per annum)	Gross Revenue (₹)	Approximate Operating Cost (₹ per annum)	Net Revenue (₹/annum)	Approximate Capital Cost (₹)	Return on Investment (Years)
			Biogas	Bio manure								
			(m ³ /day)	(Kg/day)								
50	10	2	6	8	2	71,280	24,750	96,030	40,000	56,030	5,00,000	8.9
100	12	4	12	15	5	1,42,560	49,500	1,92,060	40,000	1,52,060	9,00,000	5.9
150	12	8	18	23	7	2,13,840	75,900	2,89,740	40,000	2,49,740	13,00,000	5.2
200	15	10	24	30	10	2,85,120	99,000	3,84,120	40,000	3,44,120	17,00,000	4.9
250	20	10	30	45	12	3,56,400	1,48,500	5,04,900	50,000	4,54,900	20,00,000	4.4
500	26	12	60	75	24	7,12,800	2,47,500	9,60,300	60,000	9,00,300	32,00,000	3.6
750	30	15	90	112	36	10,69,200	3,69,600	14,38,800	2,00,000	12,38,800	40,00,000	3.2
1,000	50	20	120	150	48	14,25,600	4,95,000	19,20,600	2,50,000	16,70,600	45,00,000	2.7
5,000	600	60	600	750	240	71,28,000	24,75,000	96,03,000	20,00,000	76,03,000	1,85,00,000	2.4
10,000	1,200	120	1,200	1,500	480	1,42,56,000	49,50,000	1,92,06,000	30,00,000	1,62,06,000	3,50,00,000	2.2

Assumptions

1. Cost of commercial LPG = ₹90 per kg
2. Cost bio manure = ₹10 per kg
3. Working days in year = 330 days

Annexure 3: Circular Economy for Construction & Demolition Waste

Case Studies of successful models in India

Case Study: Burari C&D Waste Management Plant, North Delhi		
Basic Details		
1.	State Name	Delhi
2.	ULB Name & No. Of Wards	North Delhi Municipal Corporation, 104 Wards
3.	Total Estimated C&D waste Generation/Day in the ULB	2000 TPD (approx.)
4.	Quantity of C&D by Bulk waste generators	1300 TPD (approx.)
5.	Ownership	Public Private Partnership (PPP)
6.	Types of outputs/By products	Paver Blocks, Cement Bricks, Kerb Stone, Tiles, Recycled Aggregates, Recycled Concrete Aggregates
7.	Area of Plant (Land area)	7 Acre On lease provided by NDMC
8.	Current Status	Operational
9.	Month/Year of Commencement of operation (MM/YY)	07/2009 (Burari Plant)
Operational Details		
10.	Designed Capacity of Plant (TPD)	2000 TPD
11.	Average Daily Waste Intake/Processing (FY 2019-20)	1869 TPD
12.	Mechanism for Collection & Transportation of C&D wastes	ULB and Private Operator both.
13.	Collection Centre	North DMC have notified 87 locations/sites as local dumping sites in its jurisdiction. Malba in small quantity can be dumped by general public at these sites from where the same is transported to C&D waste recycling plant by the concessionaire of recycling plant in coordination with Zonal officials of North DMC
14.	Fee charged by ULB/ Operator against Collection & Transportation if any	
	Private parties	-
	ULB	At present, ₹239.44 / MT with 5% annual increase is paid to concessionaire by North DMC
	Govt. Agencies	transport the C&D waste to processing site directly

	Bulk Generators	transport the C&D waste to processing site directly
15.	Types of Process- Wet/Dry	Wet and Dry
16.	Percentage of Inert/ Processing Rejects going to Landfill	Less than 5%
Contractual/Financial Details		
17.	Total Capital Expenditure	₹26 Crore (incurred by concessionaire)
	Buy back of products	Instructions have been issued for taking mandatory provision of the items based on C&D waste recycled produce in all development works of North DMC and also recycled material is procured for departmental use at all 104 Municipal stores. These products are also being utilized by various other Govt. agencies.
	Other support	Some products are listed in Delhi Schedule of rates Review meeting taken by MOHUA to promote utilization of recycled produce
18.	Fee charged, if any, for processing (per ton)	₹205/- per MT is collected and retained by concessionaire (No processing fee is paid to concessionaire for waste of North DMC)
19.	Sales of products (FY 2019-20)	5,14,484 MT
	To private parties	2,14,048 MT
	To ULB	1,12,493 MT
	To other Govt. Agencies	1,87,943 MT

Learnings from Local Best Practices

CDW Processing Plant in East Kidwai Nagar, New Delhi

M/s Enzyme India Pvt Ltd has set up 150 TPD CDW recycling plant in 2014 on PPP model with 100% buyback by NBCC. The plant is set up at the project site of redevelopment of East Kidwai Nagar. The process is dust free and eco-friendly. The plan is to produce 30,000 bricks/ kerbstones per day which would be used at the construction site.

Supreme Court of India

Additional Office Complex for Supreme Court of India was constructed by Central Public Works Department near Pragati Maidan, New Delhi on a land area measuring 12.19 acres. The building complex was designed to be a state of the art, environment friendly, centrally air-conditioned office complex with all modern facilities. The blockwork was to be done for exterior wall masonry works where C&D blocks were used. Size of C&D block used was 400X 200 X 100 mm, grade of concrete was M-10 having compressive strength of 10 to 15 N/mm². This C&D block weight was 15 kg as compared to 3 kg for traditional brick however only 125 m³/block was consumed as compared to 500 bricks/m³.

Annexure 4: Circular Economy for Recycle and Reuse of Treated Municipal Sewage (Wastewater)

Case Study on Surat - Municipal wastewater recycling and reuse as process water for Pandesara Textile Industrial Estate in Surat

Background: Surat city, located in western part of India, is known as the economic capital of the Gujarat State. It is managed by Surat Municipal Corporation (SMC), spread over an area of 326.51 sq.km. and population of 44 lakhs as per census 2011. Pandesara is a notified industrial estate (PIE), which was established by Gujarat Industrial Development Corporation (GIDC) and falls within SMC limits.

Demand and Supply: In 2010, the water demand at Pandesara was estimated at approximately 90 MLD, comprising about 75-80 MLD of process water requirement and 10-15 MLD of potable water demand. Of the total demand, nearly 50% (around 45 MLD) was met through SMC potable water supply at the rate of ₹16/ kl in the year 2010 which was increased to ₹21/ kl in the year 2011-12. The remaining demand was met through private sources including bore wells and water tankers. Hence SMC was not able to meet entire demand of major industrial area such as PIE.

Project Concept: There is a Sewage Treatment plant at Bamroli (100 MLD capacity), which receives wastewater from houses through a sewage network and processes it for secondary treatment. The Bamroli STP was based on UASB plus extended aeration technology. The solution ADB and SMC proposed, involved setting up a Tertiary Treatment Plant (40 MLD capacity) to further treat secondary-treated sewage water from the Bamroli STP to produce and supply Industrial Grade water to the PIE. This would enable SMC to reduce pressure on ground water resources in the city and free up potable water supplied to PIE by SMC.

Project Cost: The capital cost of the project was ₹85.1 crore in 2012 and the project completion time was 18 months. The capacity of Tertiary Treatment Plant is 40 MLD with an option to scale up in a modular fashion to 80 MLD in future. The project was implemented and commissioned in May 2014.

The prevalent freshwater charges for industries were ₹ 18/ kl which were increased to ₹24/ kl in the later period. The recycled water tariff was ₹18.20/ kl in the year 2014 with annual escalation.

Project features: PIE prescribed their water quality requirement which included TDS at <500 mg/ lit. This required use of Reverse Osmosis technology and to blend the tertiary treated water with the potable water to reduce the average TDS of the industrial grade water. SMC was supplying 55 MLD of potable water to PIE and it did not want to forego the revenue it was generating from it. At the same time, PIE's water demand

was more than 90 MLD including their potable use demand. Hence, a mid-solution was proposed, to set up 40 MLD of tertiary treatment plant, then blending that water with potable water of equal capacity to reduce overall TDS and to ensure revenue to SMC. This blended water is called industrial grade water. And to address the perception of not using recycled water for human usage, a separate distribution network of 15 MLD was proposed for potable or other human usage at PIE.

Annexure 5: Circular Economy for Recycle and Reuse of Treated Sludge

Annexure – 5.1: Sludge Generation Potential and financial returns

Potential for gas generation from Sewage/ sludge	
Assuming 100% wastewater generated will be treated (as per CPCB report)	72,368
Gas generation (based on CMWSSB data {12,574/110})	114
Total gas generation	82,49,952
Per Cubic meter electricity generation (KWH)	2
Total Power generation (KWH)	1,64,99,904
Cost of per unit electricity (₹)	10
Total cost in ₹ per day	16,49,99,040
Per Year cost saving (in ₹)	60,22,46,49,600
Or ₹ crore per annum	6,022.46
Potential for Compost generation from Sewage/ sludge	
Assuming 0.25 kg of sludge/m ³ of waste water treated (Terry L. Krause, et al, 2010).	
Quantity of sludge generation (tonne/day)	18,092
Total Compost generation @ 20% of sludge (tonne/day)	3,618.4
Or tonne/year	13,20,716
Cost @ ₹5,000 per tonne	6,60,35,80,000
In Crores	660.358
Total Compost + BioGas	6,682.82296
Thus, financial return potential ₹ 6,700 pr year	

Annexure – 5.2: Case Study- Biogas Generation from STP Sludge by CMWSSB, Chennai

Chennai Metropolitan Water Supply & Sewerage Board in Chennai anaerobically digests sludge to produce bio-gas from it. Volume of gas produced is in the range of 523.92 m³ per hr (12,574 m³ per day) and is being utilized for production of power through biogas engine. The average electrical energy production from bio-gas is 2 KWh / m³ of biogas.

The digested sludge removed from the digester is passed to the sludge balancing tank at the rate of 20 m³ per hour for dewatering 5% digested sludge. The dried sludge is collected and refilled in the low-lying area inside sewage treatment plant. Details of Bio-Gas Power Production & Power Savings Cost in 7 STPs are as detailed below:

S. N	Location of STP	STP Capacity (MLD)	Capacity of Bio-Gas Engine (KW)	Bio-Gas Engine Commissioned on	Total power generated upto March 2021 (KWH)	TNEB power savings upto March- 2021 (₹ in Lakhs)
1	Kodungaiyur	110	1064	Nov-06	60,849,420	2,949.43
2	Koyambedu	60	625	Oct-05	15,330,310	648.59
3	Koyambedu	120	2 x 836	Aug-15	9,197,740	584.06
4	Nesapakkam	40	469	May-06	15,508,776	656.26
5	Nesapakkam	54	1064	Nov-13	1,353,690	68.65
6	Perungudi	54	1064	Aug-06	36,197,700	1,488.26
7	Perungudi	60	1064	Jan-12	10,386,374	682.65
	TOTAL	498	7022 KW		148,824,010	7,077.90
					Say	70.77 Crore

Dry waste

	Name	Designation & Organization
1	Shri Prabhjot Sodhi Chairman	Head Circular Economy, UNDP India
2	Prof. Babu J Alappat	Professor Civil Engg. Dept., IIT Delhi
3	Shri Hiten Beda	All India Plastic Manufacturers Association (AIPMA)
4	Shri Vinit Kapur	Secretary All India Glass Manufacturers Federation (Glass Waste)
5	Shri Lalit Garg	Secretary Federation of Indian Paper Recyclers (Paper Waste)
6	Shri Bharat Bhushan Nagar	IOSH, CWMP, IWM
7	Shri P K Kheruka	Chairman Glass Panel Capexil and CMD Borosil Renewables Ltd
8	Shri Rajesh Pahwa	CEO 21st Century
9	Shri Siddarth Hande	CEO Kabadiwala Connect
10	Shri Rahul Podar	MD Shakti Plastic Industries (Plastic Waste)
11	Shri Abhay Deshpande	Founder Recykal
12	Shri Sandeep Patel	CEO NEPRA, Ahmedabad
13	Shri Vignesh Nagle	General Manager SCM, Piramal Glass
14	Dr Syed Asad Warsi	Director Eco Pro Env. Solutions, Indore
15	Ms. Shalini Goyal Bhalla	International Council for Circular Economy
16	Shri Sandip Dutt	Plant Head Jindal Waste to Energy Plant
17	Dr Mercy Samuel	Associate Professor CEPT University, Ahmedabad
18	Dr Amit Love	Scientist E MoEFCC
19	Shri Dharmesh Makwana	Director Ministry of Consumer Affairs, Food & Public Distribution
20	Shri Jagat Narayan	Superintending Engineer MoRTH
21	Representative	Ministry of Heavy Industries (Dealing with Cement Industries)
22	Representative	Ministry of Petroleum and Natural Gas

	Name	Designation & Organization
23	Ms. Divya Sinha	Additional Director CPCB
24	Ms. Vaishali Nandan	Head Projects GIZ India, Delhi
25	Dr Ashish Chaturvedi	Director Climate Change, GIZ
26	Representative	CIPET, Chennai
27	Shri J. B. Ravinder	Joint Adviser (PHEE) CPHEEO, MoHUA
28	Shri Ankit Jain	Asst. Adviser (PHE) CPHEEO, MoHUA
29	Shri Pankaj Arora	Dry Waste Management Expert SBM(U) PMU, MoHUA
30	Ms. Archita Jain	SBM(U) PMU, MoHUA

Wet Waste

	Name	Designation & Organization
1	Dr Syed Asad Warsi Chairman	Director Eco Pro Env. Solutions, Indore
2	Dr A. Gangagni Rao	Chief Scientist CSIR-IICT, Hyderabad
3	Prof. Babu J Alappat	Professor Civil Engg. Dept., IIT Delhi
4	Col. Suresh Rege (Retd)	Director Mailhem Group
5	Dr Malini Balakrishnan	Senior Fellow Env. & Waste, Mgmt., TERI, Delhi
6	Dr Mercy Samuel	Associate Professor CEPT Univ., Ahmedabad
7	Shri P. Palaniappan	CEO Mahindra Waste to Energy Solutions Limited.
8	Ms. Divya Sinha	Additional Director CPCB
9	Dr Amit Love	Scientist E MoEFCC
10	Shri Ambarish Karunanithi	Team Lead JJM, M/o Jal Shakti
11	Shri Saurabh Shah	Excel Industries, Ahmedabad
12	Ms. Vaishali Nandan	Head Projects GIZ India, Delhi
13	Shri Varun Karad	GPS Renewables
14	Shri J.B. Ravinder	Joint Adviser (PHEE) CPHEEO, MoHUA
15	Ms. Sravanthi Jeevan K Member Secretary	Asst. Adviser (PHE) CPHEEO, MoHUA
16	Dr Himanshu Chaturvedi	SWM Expert SBM(U) PMU, MoHUA
17	Ms. Tanvi Mittal	SBM(U) PMU, MoHUA

Construction & Demolition waste

	Name	Designation & Organization
1	Dr Bibekananda Mohapatra Chairman	Director General National Council for Cement and Building Materials (NCCBM)
2	Shri Harish Kumar	Dy. Director General Central Public Works Department
3	Shri Sanjay Panth	Head (Civil Engineering) Bureau of Indian Standards (BIS)
4	Shri S.S. Gaharwar	Sr. Pr. Scientist Central Road Research Institute (CRRI)
5	Ms. Divya Sinha	Additional Director CPCB
6	Dr Amit Love	Scientist E MoEFCC
7	Shri Jagat Narayan	Superintending Engineer MoRTH
8	Shri Sandeep Malhotra	Project Head IL&FS
9	Ms. Shalini Goyal Bhalla	International Council for Circular Economy
10	Smt. Zeenat Niazi	Vice President Development Alternatives Group
11	Shri PN Ojha	NCCBM Ballabgarh
12	Shri Anupam	NCCBM Ballabgarh
13	Shri J.B. Ravinder	Joint Adviser (PHEE) CPHEEO, MoHUA
14	Ms. Ritu Pachori	Tech. Officer (PHE) CPHEEO, MoHUA
15	Dr Himanshu Chaturvedi	SWM Expert SBM(U) PMU, MoHUA

Wastewater

	Name	Designation & Organization
1.	Shri. Rajesh Biniwale Chairman	Sr. Scientist and Head NEERI
2.	Dr V K Chaurasia	JA(PHEE) MoHUA
3.	Dr Malini Balakrishnan	Senior Fellow TERI
4.	Prof. Vivek Kumar	Professor IIT Delhi
5.	Shri Prashant Bhamare	SE MJP, Maharashtra
6.	Shri R. K. Pankaj	S. E. (Ganga) UPJN
7.	Shri Lingamoorthy	Deputy Chief Engineer TWAD Board, Tamil Nadu
8.	Shri Vijay Dhawan	Executive Engineer PWSSB, Punjab
9.	Dr Pradip Tewari	Professor IIT Jodhpur
10.	Shri Sanjeev Kumar Kassi	Chief Engineer (Thermal) Ministry of Power
11.	Dr J.K. Saha	Principal Scientist Division of Environmental Sciences Indian Institute of Soil Science, Bhopal
12.	Dr Amit Love	Scientist E MoEFCC
13.	Shri Rajneesh Chopra	Global Head - Business Development VA Tech WABAG
14.	Shri Mukesh Grover	Director-Technical SUEZ
15.	Shri Shikhar Jain	Principal Counsellor CII
16.	Shri Georg Jhansen	Urban Planner & Project Manager GIZ-SUDSC project
17.	Shri. Rohit Kakkar Member Secretary	Deputy Adviser MoHUA
18.	Shri Anand Rudra	Senior Adviser, WASH USAID India
19.	Shri R.K. Srinivasan	Project Management Specialist, WASH USAID India

Municipal Sludge

	Name	Organization
1	Dr. Rajesh Biniwale	Pr. Scientist and Head Clean Tech & Modelling Division, NEERI
2	Dr.V. K. Chaurasia	JA (PHEE) CPHEEO
3	Dr. Malini Balkrishnan	Senior Fellow TERI
4	Prof. Vivek Kumar	Professor IIT Delhi
5	Dr. Pradip Tewari	Professor IIT Jodhpur
6	Shri. Prashant Bhamare	SE MJP, Maharashtra
7	Shri. R. K. Pankaj	SE (Ganga) UPJN
8	Er. Lingamoorthy	Deputy Chief Engineer TWAD Board, TN
9	Shri. Vikas Dhawan	EE PWSSB. Punjab
10	Shri. SK Kassi	Chief Engineer (Thermal) Ministry of Power
11	Dr. SK Chaudhari	DDG(NRM) ICAR, Ministry of Agriculture
12	Dr. Amit Love	Scientist E HSM Division MoEF & CC
13	Shri. Rajneesh Chopra	Global Head - Business Development VaTech Wabag
14	Shri. Mukesh Grover	Director-Technical SUEZ
15	Shri. Shikhar Jain	Principal Counsellor CII
16	Shri. V. Venugopal	GIZ
17	Shri. Mahesh Harhare	GIZ – Independent Expert
18	Shri Rohit Chandragiri	WASH Institute
16	Shri. Rohit Kakkar	Deputy Adviser (PHE) CPHEEO



SWACHHATA PLEDGE

Mahatma Gandhi dreamt of an India which was not only free but also clean and developed.

Mahatma Gandhi secured freedom for Mother India.

Now it is our duty to serve Mother India by keeping the country neat and clean.

I take this pledge that I will remain committed towards cleanliness and devote time for this.

I will devote 100 hours per year that is two hours per week to voluntary work for cleanliness. I will neither litter nor let others litter.

I will initiate the quest for cleanliness with myself, my family, my locality, my village and my work place.

I believe that the countries of the world that appear clean are so because their citizens don't indulge in littering nor do they allow it to happen.

With this firm belief, I will propagate the message of Swachh Bharat Mission in villages and towns.

I will encourage 100 other persons to take this pledge which I am taking today.

I will endeavour to make them devote their 100 hours for cleanliness.

I am confident that every step I take towards cleanliness will help in making my country clean.



सत्यमेव जयते

Ministry of Housing and Urban Affairs
Government of India