

# Harmonised Guidelines & Standards for Universal Accessibility in **India** **2021**



Ministry of Housing and Urban Affairs  
Government of India

Copyright © 2021 Gaurav Raheja, IIT Roorkee, NIUA and MoHUA

March, 2022

**Project Team**

Dr. Gaurav Raheja, Principal Investigator & Consultant  
Aishwarya Isha, Shreya Shetty  
Barsha Amrendra, Shreya Shukla

**NIUA Team**

Kanika Bansal, Lead Researcher  
Utsav Choudhury, Team Lead

**Graphic Design**

Dr. Gaurav Raheja, Shreya Shetty

**Cover Design**

Dr. Gaurav Raheja, Shreya Shetty

**Published by**

Ministry of Housing and Urban Affairs (MoHUA), New Delhi  
Government of India

**Disclaimer**

This book is intended as a guidebook for creating the best practices and acceptable standards for universal accessibility in built environments. MoHUA or the authors shall not be responsible for any loss, damage or injury that may be suffered by any person in connection with the usage of the facilities designed on the basis of the recommendations in this guidebook.

All rights reserved. No part of this publication may be reproduced, stored in a retrieval system or transmitted in any form or by any means whether electronic, mechanical photocopying, recording or otherwise, without due acknowledgements or prior written permission of the authors / Ministry of Housing and Urban Affairs.



## Technical Partners



**IIT Roorkee**



**National Institute of Urban Affairs**

## Knowledge Partner





**HARMONISED GUIDELINES & STANDARDS  
FOR UNIVERSAL ACCESSIBILITY IN **India**  
**2021****





हरदीप एस पुरी  
HARDEEP S PURI



आवासन और शहरी कार्य मंत्री  
पेट्रोलियम एवं प्राकृतिक गैस मंत्री  
भारत सरकार  
Minister of  
Housing and Urban Affairs; and  
Petroleum and Natural Gas  
Government of India

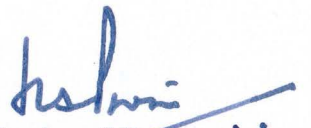
**MESSAGE**

As we reinvent our towns and cities into the fabric of a 'New Urban India' under the visionary leadership of Prime Minister Narendra Modi, the Indian Government continues to commit to the principle of 'Antyodaya Se Sarvodaya'. In fact, this principle resonates completely with the Sustainable Development Goals objective of 'Leave No One Behind'. Aligning urban infrastructure and services towards universal accessibility has been a critical component of the development framework this Government has adopted in the last seven years.

I am delighted that the Ministry of Housing and Urban Affairs is releasing the "Harmonised Guidelines and Standards for Universal Accessibility in India, 2021". As a follow-up to the earlier guidelines issued in 2016, I am glad to note that this revised version highlights India's continuing journey towards inclusion and proposes the concept of "Universal Design" as the way forward. This is a welcome upgrade and reflects the emphasis that this Government puts on equity. Many elements of internal and external built environments and building typologies have been discussed in these guidelines that are steered by a human-centric approach which prioritises making the New Urban India an Accessible India.

I congratulate the teams from CPWD, NIUA, and IIT Roorkee for preparing these guidelines. I am confident that this document will be of great value to professionals in urban planning and design, and will help them plan more inclusively. I encourage the Town and Country Planning departments, Urban Local Bodies, SPVs, and Development Authorities of all states to adopt these guidelines.

New Delhi

  
(Hardeep S Puri)







सत्यमेव जयते



## MESSAGE

It is a matter of great pride that the Ministry of Housing and Urban Affairs, Government of India has come out with the “Harmonised Guidelines and Standards for Universal Accessibility for India, 2021”. The Universal Design approach adopted for refinement of the guidelines and standards will facilitate Indian cities to be more cognizant of the needs of the marginalised groups including persons with disabilities.

Universal accessibility is the key to achieving “Inclusion” through providing equal access to opportunities of social, cultural and economic growth and promotes participation. This document will act as a practical guide for universal design of all elements of external and internal built environment, thereby catering to the accessibility needs of persons with disabilities, elderly, women, children and other population groups. The document elaborates various aspects of universal accessibility in context of implementation in Indian built environment. The guidelines for various building typologies enhance the utility of the document and ease of its use. I hope that this document will be a landmark in our journey to mainstream the dialogue on inclusion and implementation of universal accessibility in Indian cities.

I hope these guidelines will act as a milestone in building “Cities for all” by supporting the State Town and Country Planning Departments, Urban Development Authorities, Urban Local Bodies, and other implementing agencies. The State Governments should proactively and holistically adopt these guidelines for infusing inclusion into the vision of New India.

I congratulate the teams of CPWD, NIUA, Indian Institute of Technology (IIT), Roorkee and MoHUA for bringing out the document which resonates well with our commitment of making universally accessible and inclusive India.

(KAUSHAL KISHORE)



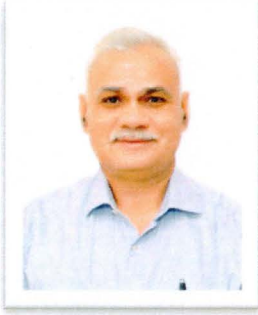


दुर्गा शंकर मिश्र

सचिव

**Durga Shanker Mishra**

Secretary



75  
आजादी का  
अमृत महोत्सव



भारत सरकार  
आवासन और शहरी कार्य मंत्रालय  
निर्माण भवन, नई दिल्ली-110011

Government of India  
Ministry of Housing and Urban Affairs  
Nirman Bhawan, New Delhi-110011

## MESSAGE

My Ministry issued the “Harmonised Guidelines and Space Standards for Barrier Free Built Environment for Person with Disability and Elderly Persons” in 2016. These Guidelines prepared a framework for development of public spaces and public buildings for universal accessibility. In the last 5 years, there have been lot of learning in implementation of these Guidelines.

Based on these experiences and information on the best practices of universal design available from across the globe, these Guidelines have been further improved and made quite user friendly. In this task Prof Gaurav Raheja from IIT, Roorkee and NIUA have played very important role in collating all the information and preparing these Guidelines and standards in lucid and easy to follow manner.

The landmark legislation “Rights of Persons with Disabilities Act, 2016” has widened the scope of inclusion and enabled the Divyangjan to contribute their best to the economy and have a dignified living. The “universal design” has been conceptualized in the Indian built and socio-cultural environment. It will support and guide the Central, States/ UTs and Local Governments in creating urban infrastructure which is universally accessible to all.

I would urge all stakeholders to follow these Guidelines in creating all infrastructure and facilities in the cities. Further, I would request the Cities and States/ UTs to integrate these Guidelines in their Bye-laws or local Building Guidelines so that all future developments are fully accessible and are aligned with the Hon’ble Prime Minister’s vision of Accessible India.

I commend the work done by NIUA, IIT Roorkee, CPWD and Team, MoHUA, who have worked on the vision of these guidelines and have made possible to bring this updated version for issuance. I would also like to thank Foreign, Commonwealth & Development Office (FCDO), British High Commission, India for funding the studies that has helped in updating our earlier issued Guidelines.

I hope this document getting published in the year of Azadi Ka Amrit Mahotsav will pave the way for universal accessibility in all Indian cities.

**(Durga Shanker Mishra)**

New Delhi

# Preface

The Harmonised Guidelines for Universal Accessibility shares a vision for a universally accessible and inclusive India. It is anticipated that every individual irrespective of age, gender, ability, health condition or socio cultural diversity enjoys equal opportunity to independently move, function, participate and perform the chosen activities of daily living and other life pursuits with dignity and independence. The role of a built environment can't be overemphasized in playing an enabling and empowering role to provide access to living with safety, convenience and with a sense of inclusion.

India's future demographic projections show an increasing trend towards ageing, disabilities, health limitations and new demands of societal transformations. The question is how to prepare our built environments for the diverse needs of people with disabilities, children, elderly, women and humans with other limitations amidst fast changing times? An obvious answer would be through being sensitive, being professionally aware and through implementing the idea of accessibility for all in every facet of the nation's development including urban infrastructures. Citizen behaviour and attitudes driven by social model approach instead of a medical or charity model approach to persons with disabilities, would play a critical role in shaping inclusive environments for future.

The Harmonised Guidelines and Standards for Universal Accessibility in India, 2021 are an enabling step towards strengthening the national mandate of an Accessible India and a self reliant India (Atmanirbhar Bharat). Through eight chapters, it lays the framework for sensitization and guidance of diverse stakeholders responsible for designing, planning and implementation of accessibility in built environments alongwith valued citizens. It provides a holistic approach towards the understanding of accessibility in an Indian context and by evolving from a barrier free approach to a universal design philosophy.

Through an elaboration of universal design principles along with the identification of accessibility needs of persons with disabilities and others, it attempts to enlarge the vision of accessibility to a larger population group through dedicated chapters on developing accessible elements in external and internal built environments. Accessibility through information design and wayfinding systems along with applications in various building typologies further

supplements the guidelines along with specific sections on Building Operations and Maintenance. Evaluating accessibility forms the concluding chapter of these guidelines.

With a set of nine distinctly colour coded chapters, the guidelines intend to provide a reader friendly experience through a well structured visual language of illustrated drawings and best practice images of accessibility.

The guidelines are intended to be read in conjunction with the existing standards of various sectors of built environment and dovetail universal accessibility in all formats. These guidelines may be used in future revisions required in other codes as well. It is highly recommended to develop the mechanisms of accessibility evaluations on a periodic basis in line with the proposed Harmonised Guidelines, 2021. They need to be adopted across all built environment practices of all scales from master planning to building interiors and services.

The preparation of these guidelines involved relentless efforts by a dedicated team from IIT Roorkee along with the National Institute of Urban Affairs guided by the Ministry of Housing and Urban Affairs. Coordinated efforts of these teams with the support from CPWD, Department of Empowerment of Persons with Disabilities, Ministry of Social Justice have led to the document in its current shape and form.

The Harmonised Guidelines 2021 intend to be used as a reference for various stakeholders of built environment including the State Governments, the Development Authorities, the Planning Organisations, and Private Sector. Besides the above, it is envisaged that these guidelines shall be dovetailed in curricula of academic and research institutions of architecture, planning, engineering, design education and beyond to prepare sensitised professionals for an inclusive future.

**Prof.(Dr.) Gaurav Raheja**

December 2021  
IIT Roorkee, India

# Acknowledgements

In pursuance to the UNCRPD 2007 and Rights for Persons with Disabilities Act 2016 and to make built environment universally accessible, the Ministry of Housing and Urban Affairs, Government of India took upon itself the task of preparation of the 'Harmonised Guidelines and Standards for Universal Accessibility in India - 2021'. These guidelines intend to address the accessibility needs of persons with disabilities, elderly, women, children and other user groups with special needs, in the context of built environments, thus paving the way for universally accessible and an inclusive India.

These guidelines are an outcome of a participatory approach through widespread consultations with various Central Government Ministries, Civil Society Organizations, National Institutes, State Governments. Inputs have also been taken from diverse user groups, industry experts and international standards and guidelines.

The exercise of formulation of these guidelines was carried out under the overall leadership and guidance of Shri Ved Prakash, Joint Secretary (works), with constant support from Shri Durga Shanker Mishra, Secretary, Ministry of Housing and Urban Affairs.

Dr. Gaurav Raheja, Professor IIT Roorkee as a Principal Investigator and Consultant to the project along with his dedicated team comprising of Ms. Aishwarya Isha, Ms. Shreya Shetty, Ms. Barsha Amrendra and Ms. Shreya Shukla made persistent efforts in conceptualizing, revising and drafting these guidelines. The Ministry acknowledges the exhaustive work done by IIT Roorkee and by the team of National Institute of Urban Affairs (NIUA) for the entire process ranging from developing content, reviewing to gathering inputs from various stakeholders. The efforts made by Shri Hitesh Vaidya, Director NIUA and his team - Utsav Choudhury and Kanika Bansal are deeply acknowledged for the tireless engagement in the development of these guidelines.

Gratitude is also extended to the officers of Central Public Works Department, particularly Shri Surender Singh (ADG-Works), Shri Abhishek Bose (Senior Architect- Works) and their team - Rajesh Singh, Renu Bhutani, Nidhi Gupta and Deepali Mishra for their coordination and constant involvement in detailed discussions on all aspects of Harmonised Guidelines.



The revision of Harmonised Guidelines would not have been possible without the valuable inputs and suggestions provided by so many other participants and contributors including the reviews carried out by the Chief Commissioner of Persons with Disabilities and Ministry of Social Justice and Empowerment.

The authors and the teams duly acknowledge the support rendered by countless anonymous individuals whose individual case studies, experiential insights and interactions with them added value to the preparation of this document. We are humbled with their valued contributions and express our sincere gratitude to all those who have been associated with the journey of this preparation and also would extend it to the implementation in times to come.

# Contents

Message by Minister, MoHUA	iii
Message by Minister of State, MoHUA	v
Message by Secretary	vii
Preface	viii
Acknowledgements	x
Acronyms	xvii

---

## 1

### **INTRODUCTION** **1**

1.1	Introduction	1
1.2	Objectives	2
1.3	National Policy Perspectives	3
1.4	International Policy Perspectives	7
1.5	Methodology of Guide Development	9
1.6	Applications and Stakeholders	10
1.7	Guiding Philosophy	12

---

## 2

### **ACCESSIBILITY, DIVERSITY AND UNIVERSAL DESIGN** **17**

2.1	Diversity and Inclusion : Perspectives to Accessibility	18
2.2	Understanding Universal Design	18
2.3	Understanding Disability & Diversity	25
2.4	Accessibility Needs for Persons with Disabilities	28
2.5	Accessibility Needs for Diverse User Groups	31

2.6	Barriers to Accessibility in Built Environments	34
2.7	Basic Anthropometry and Space Allowances	48
2.8	Accessibility Framework for Built Environments	48

# 3

## **EXTERNAL ELEMENTS 57**

3.1	Master Planning	57
3.2	Site Planning	62
3.3	Site Entrances	63
3.4	Parking	63
3.5	Access Routes / Walkways	75
3.6	Levels, Grooves and Gratings	80
3.7	Kerb Ramps	84
3.8	Pedestrian Crossings	84
3.9	Tactile Guiding Surface Indicators (TGSIs)	91
3.10	External Ramps	104
3.11	Handrails and Grab Bars	105
3.12	Outdoor Drinking water provision	115
3.13	External Sanitary Provisions	119
3.14	Street Furniture Elements	122
3.15	External Landscapes	129

# 4

## **INTERNAL ELEMENTS 151**

4.1	Building Entrances	151
4.2	Waiting Areas and Seating Spaces	154
4.3	Reception Areas, Service or Information Counters	157
4.4	Internal Corridors and Access Routes	160
4.5	Staircase	164
4.6	Internal Ramps	168
4.7	Lifts and Escalators	171
4.8	Accessible drinking water stalls	185
4.9	Internal Sanitary Provisions	188
4.10	Internal Doors & Fixtures	238
4.11	Windows	243
4.12	Guest Rooms	245
4.13	Eating Spaces	245
4.14	Wardrobes and Storage Shelves	250
4.15	Controls and Operations	251

# 5

## **INFORMATION & WAYFINDING SYSTEMS 259**

5.1	Information System Perspectives	259
5.2	Signage and Wayfinding	260
5.3	Location	270
5.4	Visual Comfort and Colour Contrast	270
5.5	Tactile and Multi Sensory Information Systems	275
5.6	Tactile maps	276



---

# 6

## **BUILDING TYPOLOGIES 291**

6.1	Residential Buildings	301
6.2	Education and Research Buildings	309
6.3	Transportation and Supporting Infrastructure Services	315
6.4	Office and Public Buildings	340
6.5	Healthcare Buildings	342
6.6	Retail and Commercial Buildings	346
6.7	Cafeterias, Restaurants and Dining Facilities	350
6.8	Hotels and Hospitality Buildings	351
6.9	Assembly Buildings	354
6.10	Judicial and Legal Buildings	356
6.11	Urban Public Spaces	358
6.12	Sports Buildings and Infrastructure	367
6.13	Religious Buildings	368
6.14	Recreational Buildings and Spaces	370
6.15	Heritage Buildings and Sites	372
6.16	Industrial Buildings	372
6.17	Bank ATMs and Vending Machines	373

---

# 7

## **BUILDING OPERATIONS & MAINTENANCE 381**

7.1	Building Access Strategy	381
7.2	Building Management	382
7.3	Emergency Evacuation Needs	386

7.4	Building Operations and Accessible Technologies	391
7.5	Retrofitting	391

---

# 8

## **EVALUATING ACCESSIBILITY** **397**

8.1	Access Audits	397
8.2	Accessibility Rating Mechanism	399
8.3	Developing Accessibility Report	399
8.4	Accessibility Checklists	401

---

# 9

## **APPENDICES** **421**

Appendix 1: References	421
Appendix 2: Slip resistance materials	423
Appendix 3: Glossary	425

# Acronyms

BRTS	Bus Rapid Transit System
DTC	Delhi Transport Corporation
FOB	Foot Over Bridges
HL	Hearing Loss
LRV	Light reflectance value
MCD	Municipal Corporation of Delhi
MoHUA	Ministry of Housing and Urban Affairs
MRTS	Mass Rapid Transit System
MSJ&E	Ministry of Social Justice & Empowerment
NDMC	New Delhi Municipal Council
NIUA	National Institute of Urban Affairs
NGO	Non-Government Organization
PRM	Persons with Reduced Mobility
PWD	Public Works Department
PwDs	Persons with Disabilities
RFID	Radio Frequency Identification
ROW	Right of Way
RPwD	Rights of Persons with Disabilities
TGSI	Tactile Ground Surface Indicators
TRB	Transport Research Board
ULB	Urban Local Body
UNCRPD	United Nations Convention on Rights of Persons with Disabilities
WwD(s)	Woman / en with Disability / ies

# List of Figures

Figure 1.1	Holistic Framework for Universal Accessibility Implementation	2
Figure 1.2	National and International Policy Perspectives	4
Figure 1.3	Methodology for developing Harmonised Guidelines 2021	8
Figure 1.4	Stakeholder Framework	11
Figure 1.5	Key features of Guiding Approach	12
<hr/>		
Figure 2.1	Accessibility framework for Built Environment	17
Figure 2.2	The Seven Principles of Universal Design	20
Figure 2.3	Universal Design: The Eight Goals	22
Figure 2.4	Universal Design India Principles	24
Figure 2.5	Understanding Disability & Diversity	25
Figure 2.6	Minimum widths of a clear walkway for diverse user groups	49
Figure 2.7	Reach ranges for wheelchair users	50
Figure 2.8	Wheelchair dimensions	50
<hr/>		
Figure 3.1	Accessible site entrances: Typical detail A	64
Figure 3.2	Accessible site entrances: Typical detail B	65
Figure 3.3	Vehicle parking (two wheeler parking/ adapted scooters)	69
Figure 3.4	Accessible car parking bays: Plan Layout/Section	72
Figure 3.5	Accessible car parking bays: 3d Visualization	73
Figure 3.6	Typical accessible car parking unit: Type A	74
Figure 3.7	Typical accessible car parking unit: Type B	75
Figure 3.8	Accessible street grating typologies	82
Figure 3.9	Accessible street grating details: Sectional elevation	83
Figure 3.10	Accessible street grating details: Plans layout	83
Figure 3.11	Accessible kerb ramp: Typical detail A	86
Figure 3.12	Accessible kerb ramp: Typical detail B	87

Figure 3.13	Tactile guiding surface indicators (TGSIs) detail	94
Figure 3.14	Typical TGSi junction details	97
Figure 3.15	Configuration and layout of tactile guiding and warning tiles	98
Figure 3.16	TGSi layout details around manhole covers on sidewalks	102
Figure 3.17	Handrail detail	107
Figure 3.18	Handrail Extensions	108
Figure 3.19	Sectional view of edge protection for ramps	109
Figure 3.20	Handrail profiles and fixing details	110
Figure 3.21	Contrasting colour, Coloured bands and detectable warning surfaces on ramps	111
Figure 3.22	Staircase: Step profile and detectable warning strips	112
Figure 3.23	Ramp: Step profile and detectable warning strips	113
Figure 3.24	Outdoor water fountain	115
Figure 3.25	Drinking water fountain details: Type A	116
Figure 3.26	Drinking water fountain details: Type B	117
Figure 3.27	Outdoor seating: Elevation	123
Figure 3.28	Outdoor seating: 3d visualization Type A	123
Figure 3.29	Accessible seating typologies: 3d visualization Type B	125
Figure 3.30	Bollard Details	127
Figure 3.31	Street obstruction: Typical detail type A & B	130
Figure 3.32	Street obstruction: Typical detail type C & D	131
Figure 3.33	Street obstruction: Typical detail type E & F	132
Figure 3.34	Typical ticket counter details showing accessible heights	133
Figure 3.35	Vending machine	135
Figure 3.36	Information display board	135
Figure 3.37	Outdoor phone unit	136
Figure 3.38	Accessible paved pathways with grass pavers	138
Figure 3.39	Dimension and space requirement for seating in parks and green spaces	142
Figure 3.40	Dimension and space requirement for water edge/ waterfront seating	143

Figure 4.1	Typical configurations of waiting areas with reserved accessible seating	156
Figure 4.2	Reception counter with accessible heights	159
Figure 4.3	Accessible Service and Information Counters	159
Figure 4.4	Dimension and space requirement for right-angled accessible corridor	160
Figure 4.5	Dimension and space requirement for accessible corridor	161
Figure 4.6	Accessible corridor widths for diverse contexts	161
Figure 4.7	Staircase details with accessibility features	165
Figure 4.8	Typical details of Straight ramp	168
Figure 4.9	Typical details of 'U' Shaped ramp	168
Figure 4.10	Typical details of 'L' Shaped ramp with steps: Type A	169
Figure 4.11	Typical details 'L' Shaped ramp with steps: Type B	170
Figure 4.12	Typical details of L Shaped ramp: Type C	171
Figure 4.13	Accessible lift car layout and controls	174
Figure 4.14	Accessible lift cars in parallel layout	175
Figure 4.15	Typical section of an accessible lift car	176
Figure 4.16	Wheelchair platform stairlifts for straight staircase	182
Figure 4.17	Wheelchair platform stairlifts for 'U' shaped staircase	183
Figure 4.18	Lift platform dimensions	184
Figure 4.19	Platform lift	185
Figure 4.20	Enclosed platform lift	185
Figure 4.21	Typical layouts for accessible drinking water fountain	188
Figure 4.22	Accessible public toilet layout: Type A	195
Figure 4.23	Accessible public toilet layout: Type B	196
Figure 4.24	Family Toilet detail	197
Figure 4.25	Detail of accessible washroom with double swing door: Plan Layout	202
Figure 4.26	Detail of accessible washroom with sliding door: Plan layout	203
Figure 4.27	Detail of accessible washroom: Sectional elevation	204

Figure 4.28	Detail of accessible Indian washroom with sliding door: Plan layout	205
Figure 4.29	Detail of accessible Indian washroom with double swing door: Plan layout	208
Figure 4.30	Detail of accessible Indian washroom: Sectional elevation	209
Figure 4.31	Ambulant Toilet detail: Plan Layout	211
Figure 4.32	Ambulant Toilet detail: Sectional elevation	212
Figure 4.33	Ambulant Indian Toilet detail: Plan layout	213
Figure 4.34	Ambulant Indian Toilet detail: Sectional elevation type A	214
Figure 4.35	Ambulant Indian Toilet detail: Sectional elevation type B	215
Figure 4.36	Detail of accessible washroom: Sectional elevation	220
Figure 4.37	Accessible Urinals	224
Figure 4.38	Changing room with seat details	228
Figure 4.39	Typical Residential Toilet detail: Type A	236
Figure 4.40	Typical Residential Toilet detail: Type B	237
Figure 4.41	Minimum maneuvering space for two aligned doors in a series	239
Figure 4.42	Minimum Doorway Manoeuvring Space in Series	240
Figure 4.43	Doors	241
Figure 4.44	Door details	242
Figure 4.45	Unobstructed view	244
Figure 4.46	Storage space for a wheelchair user	250
Figure 4.47	Electrical controls mounting details	251
<hr/>		
Figure 5.1	Information Display Counter	262
Figure 5.2	Height and placement of signages	279
<hr/>		
Figure 6.1	Adapted Mobility Pyramid	315
Figure 6.2	Road Intersection with accessible features	316
Figure 6.3	Bus shelter details	320



Figure 6.4	Taxi drop off stand	324
Figure 6.5	Configuration and layout of tactile guiding and warning tiles for metro	328
Figure 6.6	Accessible public building	341
Figure 6.7	Accessibility examples from India	376
<hr/>		
Figure 7.1	Fire Safety and Evacuation Features: Elevation View	387

---

**Note**      *All dimensions in the figures are in mm, unless specified*

# LIST OF IMAGES

Image 2.1	Inaccessible information design at bus shelter	34
Image 2.2	Barrier: Legibility	35
Image 2.3	Absence of adequate visual contrast in steps	36
Image 2.4	Inaccessible entrance	36
Image 2.5	Improper parking management	37
Image 2.6	Inaccessible entrance with inadequate visual contrast in steps	37
Image 2.7	Improper ramp gradient and slippery floor finish	38
Image 2.8	Rumble granite strip on ramps as a barrier	38
Image 2.9	Curved ramp with improper detailing and design	39
Image 2.10	Inadequate visual contrast	39
Image 2.11	Inadequate colour contrast	40
Image 2.12	Planters as barrier and inadequate ramp slope	40
Image 2.13	Absence of kick plate and lever handle	41
Image 2.14	Improper ramp detailing	41
Image 2.15	Improper edge detailing of level change	41
Image 2.16	Inaccessible heights for wheelchair users and children	42
Image 2.17	Inconsistent tactile markings and physical obstructions on sidewalks	42
Image 2.18	Poor visual contrast in entrance steps	43
Image 2.19	Poor maintenance of sidewalks and tactile pathways	43
Image 2.20	Inconsistent laying of tactile guiding tiles	43
Image 2.21	Obstructions on tactile pathway	44
Image 2.22	Improper space and traffic management	44
Image 2.23	Inaccessible street infrastructure	44
Image 2.24	Improper ramp detailing and management	45
Image 2.25	Inaccessible counter heights	45
Image 2.26	Typical Barrier in built environment	46
Image 2.27	High kerbs and absence of kerb ramps near zebra crossing	47

Image 3.1	Accessibility in Master Planning urban infrastructure	58
Image 3.2	Integrating accessibility through Site Planning	60
Image 3.3	Accessible reserved Vehicle parking	66
Image 3.4	Accessible reserved parking bays	68
Image 3.5	Parking space requirement for adapted scooter	68
Image 3.6	Accessible four wheeler parking bays	70
Image 3.7	Access Routes in outdoor landscapes	76
Image 3.8	Access Routes in outdoor landscapes	76
Image 3.9	Pedestrian pathways	77
Image 3.10	Access Ramps with steps	77
Image 3.11	Accessible Pedestrian Pathway	79
Image 3.12	Accessible grating details ( Perforated grating type)	81
Image 3.13	Accessible flared kerb ramp at pedestrian crossing	85
Image 3.14	Accessible road intersection with pedestrian crossing	88
Image 3.15	Pedestrian crossing with pelican signals	89
Image 3.16	Accessible Pedestrian crossing	90
Image 3.17	Accessible transportation environment with Tactile Pavers with good visual contrast	92
Image 3.18	Tactile pavers road layout	99
Image 3.19	TGSI pathway in horizontal circulation	100
Image 3.20	Accessible ramps at building entrance	103
Image 3.21	Accessible horizontal circulation with handrail	106
Image 3.22	Handrails as support in accessible staircase and escalators	114
Image 3.23	Accessible drinking water provision	118
Image 3.24	Faucets: Not recommended	121
Image 3.25	Faucets: Recommended	121
Image 3.26	Street Furniture typical example seating	124
Image 3.27	Seating with external landscapes	126
Image 3.28	Typical bollard placement for accessible sidewalk with tactile pavers: Church Street	128

Image 3.29	Ticket counters	134
Image 3.30	Outdoor telephone unit	137
Image 3.31	Accessible external landscape with tactile pathways	139
Image 3.32	Street Pavers	140
Image 3.33	Ramp with guard rails	144

---

Image 4.1	Access to building	153
Image 4.2	Accessible waiting area	155
Image 4.3	Accessible seating spaces	155
Image 4.4	Accessible service and information Counter	158
Image 4.5	Internal corridor with tactile tiles	163
Image 4.6	Staircase with color contrast and tactile tiles	166
Image 4.7	Accessible Lift door	173
Image 4.8	Accessible call buttons in the lift	177
Image 4.9	Tactile pavers layout towards the lifts access	178
Image 4.10	Accessible control panel in the lift	179
Image 4.11	Wheelchair stairlift	181
Image 4.12	Accessible Drinking water facility	187
Image 4.13	Accessible Drinking water fountains	189
Image 4.14	Accessible Unisex/Gender neutral washroom	198
Image 4.15	Vending Machine for sanitary napkins	200
Image 4.16	Accessible gender neutral washroom	201
Image 4.17	Accessible Washroom	206
Image 4.18	Accessible Toilet	210
Image 4.19	Grab bars in the Accessible Washroom	216
Image 4.20	Accessible Washroom	217
Image 4.21	Accessible Washbasin	219
Image 4.22	Accessible sensor based faucet	221
Image 4.23	Accessible Urinals	223
Image 4.24	Accessible Urinal with grab bar	225
Image 4.25	Accessible Washroom with SOS facility	226
Image 4.26	Shower seats	228

Image 4.27	Accessible child-sized Wash basin	230
Image 4.28	Accessible Washroom with diaper changing station	230
Image 4.29	Child Protection Seat	231
Image 4.30	Accessible Baby changing facility	232
Image 4.31	Signage for accessible toilets	233
Image 4.32	Indian WC Signage	234
Image 4.33	Fold-able seat for changing room	235
Image 4.34	Accessible entry to an eating space	246
Image 4.36	Typical accessible seating furniture	247
Image 4.35	Typical accessible seating arrangement	247
Image 4.37	Accessible furniture in an eating space	249
Image 4.38	Accessible digital kiosk	253
Image 4.39	Accessible hand sanitiser units	254
<hr/>		
Image 5.1	Signage and Wayfinding	261
Image 5.2	Directional sign with multi-lingual text and complementing pictograms	263
Image 5.3	Emergency exit signage	264
Image 5.4	Lift controls integrated with Braille	264
Image 5.5	Identification signs on the golf cart in the airport	266
Image 5.6	Identification signs on airport buggy	266
Image 5.7	Instructive signs in the washroom	267
Image 5.8	Instructive signs in the toilet	267
Image 5.9	Instructive signs at an accessible telephone unit	268
Image 5.10	Instructive signs at an accessible drinking water unit	268
Image 5.11	Floor signage at a transportation hub	269
Image 5.12	Braille sign on handrail bars	269
Image 5.13	Colour contrast on staircase	272
Image 5.14	Braille cum tactile sign board	275
Image 5.15	Braille cum tactile route map	277
Image 5.16	Braille cum tactile sign board	278
Image 5.17	Public toilet signage	



Image 5.18	Wayfinding Signs	280
Image 5.19	Wayfinding signs on the street: Pune	281
Image 5.20	Reserved accessible sign in public transport	282
Image 5.21	Assembly point sign	283
Image 5.22	Indian Sign Language	284
Image 5.23	Bharati Braille	285
Image 5.24	Priority seating signs	286
Image 5.25	Lift priority Signs	286
<hr/>		
Image 6.1	Accessible green areas	302
Image 6.2	Accessible ramp at the entrance of an apartment building	303
Image 6.3	Accessible outdoor play space with safety child seating	307
Image 6.4	Accessible outdoor play equipment with safe surface material	307
Image 6.6	Accessible indoor play arena	308
Image 6.5	Accessible play room interiors	308
Image 6.7	Accessible indoor sensory play areas	309
Image 6.8	Accessible classroom facility	311
Image 6.9	Accessible computer laboratory	312
Image 6.10	Accessible playground with variety of play options	314
Image 6.11	Accessible approach for bus shelter	317
Image 6.12	Accessible bus station: Ahmedabad BRTS	318
Image 6.13	Accessible bus shelter	318
Image 6.14	Accessible bus station with level approach	319
Image 6.15	Accessible bus interiors	321
Image 6.16	Accessible buses with level approach: Ahmedabad BRTS	322
Image 6.17	Accessible buses with folding ramp	322
Image 6.18	Accessible Taxi: pick up and drop off	323
Image 6.19	Accessible metro rail	325
Image 6.20	Leveled approach on accessible train platform	327

Image 6.21	Inclusive vertical circulation in train station enabled with Lift, staircase and escalator	327
Image 6.22	Accessible metro rail coach design and seating	329
Image 6.23	Accessible metro station entrances: Kochi Metro Station	330
Image 6.24	Color contrast and Leveled platform, Koch Metro Rail	330
Image 6.25	Color contrast and TGSi layout: Koch Metro Rail	331
Image 6.26	Color contrast and Illumination on Metro Platform	331
Image 6.27	Reserved accessible seating inside metro rail coach	332
Image 6.28	Accessible automatic fare collection (AFC) system in Metro Stations	333
Image 6.29	Accessible airport facilities: Tactile ground surface indicator used inside airport	334
Image 6.30	Accessible ramps for aircraft boarding	335
Image 6.31	Golf carts at the airport	336
Image 6.32	Accessible baggage belt at the airport	337
Image 6.33	Accessible Travellator at the airport	337
Image 6.34	Accessible aerobridge for boarding the passenger	338
Image 6.35	Accessible entrance for office building	340
Image 6.36	Accessible hospital beds, emergency call button and Golf carts at the hospital	343
Image 6.37	Accessible internal ramp in the hospital	344
Image 6.38	Accessible retail space	348
Image 6.39	Accessible book store	350
Image 6.40	Outdoor access to retail spaces	351
Image 6.41	Accessible cafe	352
Image 6.42	Accessible digital kiosk	353
Image 6.43	Accessible restaurant seating arrangement	355
Image 6.44	Accessible seating in a convention center	357
Image 6.45	Accessible open air theatre	360
Image 6.46	Accessible public space features: Dilli Haat, Delhi	361
Image 6.47	Accessible public space features: Garden of five senses, Delhi	362
Image 6.48	Accessible public space features: Chandini Chowk, Delhi	

		363
Image 6.49	Accessible public space features: Sabarmati Riverfront, Ahmedabad	364
Image 6.50	Accessible public space features: Indian Music Experience Museum	365
Image 6.51	Accessible public space features	365
Image 6.52	Seating provision on the street	366
Image 6.53	Accessible seating	366
Image 6.54	Accessible smart public toilet	367
Image 6.55	Accessible sports infrastructure	368
Image 6.56	Accessible Religious building complex	369
Image 6.57	Accessible heritage building	371
Image 6.58	Accessible entrance to a bank ATM	374
Image 6.59	Accessible ATM Machine	375
<hr/>		
Image 7.1	Emergency exit door	385
Image 7.2	LED Beacon	389
Image 7.3	Fire Alarm Bell	389
Image 7.4	Fire Alarm	389
Image 7.5	Cardiac emergency	390
Image 7.6	Retrofitted ramp as an accessible entrance of a guest house	392
Image 7.7	Retrofitted accessible entrance through ramps in a heritage building	393

---

**Note**

*The images shown in the guidelines are reference images for showcasing good practices of accessibility. However, for the purpose of implementation, it is recommended to use drawings / illustrations only.*

# List of Tables

Table 2.1	Understanding Disability & Diversity	26
Table 2.2	Children’s Reach Ranges	48
<hr/>		
Table 3.1	Accessible Reserved Parking (Four Wheeler)	67
Table 3.2	Changes in levels	80
Table 3.3	Luminance Contrast	96
Table 3.4	Gradient and Length of Ramps	104
<hr/>		
Table 4.1	Design recommendations for universally accessible washroom design	190
<hr/>		
Table 5.1	Wheelchair parking space requirement	258
Table 5.2	Wayfinding process	260
Table 5.3	Arrow alignment, typology and hierarchy	265
Table 5.4	Schedule of Colour Contrast for Signs	271
Table 5.5	Size of signage	273
Table 5.6	Viewing distance and height of letters	274
Table 5.7	Illuminance	274
<hr/>		
Table 6.1	Classification of Building Typologies	291
Table 6.2	Minimum Accessibility Provisions in Different Building Occupancies	294
Table 6.3	Accessible Seating Ratios	356
<hr/>		
Table 8.1	Accessibility Rating Scale [ARS] ©	398
Table 8.2	Site entrance checklist for accessibility	402
Table 8.3	Parking checklist for accessibility	402
Table 8.4	Access routes checklist for accessibility	403
Table 8.5	Kerb ramps checklist for accessibility	404
Table 8.6	Ramps checklist for accessibility	404

Table 8.7	Main entrance checklist for accessibility	405
Table 8.8	Reception and information counters checklist for accessibility	406
Table 8.9	Corridors checklist for accessibility	407
Table 8.10	Doors checklist for accessibility	407
Table 8.11	Lifts checklist for accessibility	408
Table 8.12	Staircase checklist for accessibility	409
Table 8.13	Handrails checklist for accessibility	410
Table 8.14	Sanitary Provisions checklist for accessibility	411
Table 8.15	Drinking Water checklist for accessibility	412
Table 8.16	Outdoor eating outlet checklist for accessibility	413
Table 8.18	Emergency evacuation checklist for accessibility	414
Table 8.19	Public telephones checklist for accessibility	415
Table 8.20	Resting facilities checklist for accessibility	415





GATEWAY DELHI  
6 6

Rajiv Chowk  
राजिव चौक

Act Smart • Travel Safe • Use Smart Card  
SMART CARDS BY RAJIV CHOWK CUSTOMER CARE CENTRE  
DELHI METRO

NO  
RIGHT TURN

राजिव चौक  
RAJIV CHOWK  
राजिव चौक





*Today, on the International Day of Persons with Disabilities we reaffirm our commitment to keep working towards an inclusive, accessible and equitable future for our Divyang sisters and brothers. Their fortitude and accomplishments in various fields inspire all of us.*

**Shri Narendra Modi**  
**Prime Minister, India**

Twitter Post by @narendramodi, 3 Dec 2019,  
Address on International Day of Persons with Disabilities



*United Nations : Convention on the Rights of Person with Disability | Accessible India Campaign | R P W D Act*







*The problem is not how to wipe out all differences, but how to unite with all differences intact.*

*-Rabindranath Tagore*





# INTRODUCTION

## 1.1 Introduction

The idea of universality, non discrimination, equity and inclusion of diversity both in symbolic and real terms is well reflected in the Indian context as stated in the given quote by Gurudev Rabindranath Tagore.

The progressive reality of twenty first century India needs to extend these thoughts into practice of urban futures and built environments, which at times play a crucial role in disabling or enabling a human experience. Universal accessibility in a broader sense forms one of the key means to include all, ranging from persons with disabilities to other diverse user groups in the urban Indian context. Creating human centric, safe and inclusive environments for all, will perhaps be the surest ways to prepare for the demographic transformations and challenges of age, ability, gender and cultures in Indian futures.

Key elements of an urban built environment, information systems, infrastructure developments and their internal services play an active role in shaping one's accessibility experience. Missing out on a small component amongst the above can also exclude several humans with special needs and likewise, presence of small and apt

features can enhance inclusion for many.

The complex Indian diversity and pluralistic approach requires to be further strengthened through envisioning, creating and maintaining inclusive built environments for all without compromise. This could only be possible through sustained efforts to improve sensitisation towards accessibility among all stakeholders responsible for the conceptualisation and realisation of built environments along with common citizens.

Persons with disabilities, elderly, women and children along with other vulnerable population groups like ones with terminal health conditions, expectant mothers, persons with obesity or other invisible disorders, etc. need to be considered at all levels of design and planning decisions in built environment and services alongwith procurement and implementation processes. The Harmonised Guidelines for Universal Accessibility 2021 succeeds the earlier version of Harmonised Guidelines 2016 amidst new transformations and visions for urban futures and built environments in India. The new guidelines and standards complement the parallel existence of the National Building Code 2016, Model Building Bye Laws 2020 and other relevant codes while adhering to the mandates of the Rights of Persons with Disabilities Act, 2016.



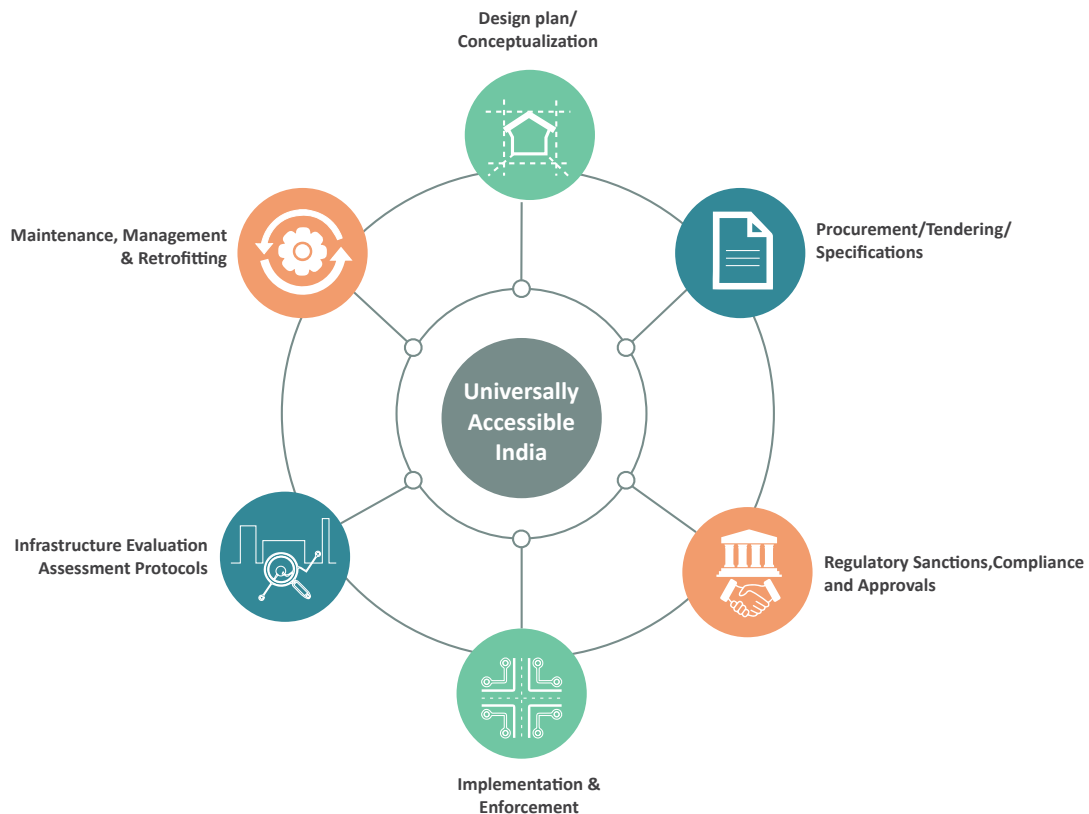


Figure 1.1 Holistic Framework for Universal Accessibility Implementation

Emerging futures of built environments, human diversity and new technologies together share an immense potential to be mutually inclusive and leaving no one behind. This, as a key approach of Universal Design, forms the core principle for these guidelines to shape the implementation of our built infrastructures in various sectors of housing, mobility, education, health, work and recreation.

Accessibility needs to become a unifying feature in all built environments and an expected experience of all services rendered to a wide range of population groups. Progressive national policies and campaigns towards implementation of accessibility in various facets of Indian built environments shall further render these guidelines handy towards their grounded implementation.

## 1.2 Objectives

The proposed universal accessibility guidelines aim to sensitize, guide and facilitate the approach towards implementing accessibility in all facets of built environment and beyond. It intends to build a focus towards the creation of inclusive environments for all, by meeting wide ranging accessibility needs of persons with disabilities, elderly, women, children and all others through the universal design approach. Guided by the Model of holistic approach to Universal Accessibility (Refer Fig: 1.1), following are the key objectives of these guidelines:

1. Sensitize diverse stakeholders regarding the various accessibility needs and provisions for diverse population groups in the built environment.
2. Introduce and orient universal design

perspectives to all stakeholders for creating inclusive built environments for all.

3. Recommend specific built environment elements along with their accessibility attributes and specifications.
4. Develop a holistic approach to accessibility through integration of appropriate technologies.
5. Guide accessibility assessment and implementation in built environments.

### 1.3 National Policy Perspectives

Over the past few years, several National policies have evolved in India that orient the perspectives of shaping built environments and services towards greater accessibility for all.

#### 1.3.1 Rights for Persons with Disabilities Act, 2016

Rights of Persons with Disabilities Act, 2016 is a landmark act which reinforces the idea of equity and non discrimination for persons with disabilities in its various sections. Not only does it endorse accessibility as an essential requirement for all built environments and in all walks of life, it also clearly advocates the idea of non discrimination in all services rendered both by public and private sectors in diverse domains. This implies accessibility as a mandatory provision in all building typologies including housing, education, mobility or transportation, health, work or employment, recreation and any other domain of built forms not listed above.

The RPWD Act, 2016<sup>22</sup> specifies twenty one types of disabilities within the ambit of the law and also introduces a category

of 'persons with benchmark disabilities' beyond the specified disabilities. The specified disabilities include

1. Physical Disability
  - a. Leprosy cured persons
  - b. Cerebral Palsy
  - c. Dwarfism
  - d. Muscular Dystrophy
  - e. Acid attack victims
2. Visual Impairment
  - a. Blindness
  - b. Low vision
3. Hearing Impairment
  - a. Deaf
  - b. Hard of Hearing
4. Speech and Language disability
5. Intellectual Disability
  - a. Specific learning disabilities
  - b. Autism spectrum disorder
6. Mental Behaviour
  - a. Mental illness
7. Disability caused due to
  - a. Chronic neurological conditions viz.
    - (i) Multiple sclerosis
    - (ii) Parkinson's disease
  - b. Blood disorder viz.
    - (i) Haemophilia
    - (ii) Thalassemia
    - (iii) Sickle cell disease
8. Multiple Disabilities (more than one of the above specified disabilities) including deaf blindness.

In adherence to the above Act and responsiveness to an inclusive urban future, it is vital to progressively work towards accessible infrastructures in



Figure 1.2 National and International Policy Perspectives

built environments Provisions under this act not only highlight their relevance but also make it mandatory for built environments to make them accessible.

Chapter VIII of the RPWD Act clearly highlights the idea of non discrimination in built environments.

A brief reiteration of Section 40 and 44 from the RPWD, 2016 is stated below to highlight the focus on accessibility through Harmonised guidelines. It also highlights the accessibility perspectives as per the law. Besides that, it mentions the other relevant Sections 41, 42 and 43.

#### Section 40 Accessibility

The Central Government shall, in consultation with the Chief Commissioner, formulate rules for persons with disabilities laying down the standards of accessibility for the physical environment, transportation, information and communications, including appropriate technologies and systems, and other facilities and services provided to the public in urban and rural areas.

#### Section 41 Access to Transport

#### Section 42 Access to information and communication technology

#### Section 43 Consumer Goods

#### Section 44 Mandatory observance of accessibility norms.

1. No establishment shall be granted permission to build any structure if the building plan does not adhere to the rules formulated by the Central Government under section 40.
2. No establishment shall be issued a certificate of completion or allowed to take occupation of a building unless it has adhered to the rules formulated by the Central Government.

It would be important for all those involved in the development or management of built environments to be conscious of the mandates as issued by the RPWD Act and should render the creation of built environments in compliance to the same.

### 1.3.2 Accessible India Campaign, 2015

The Government of India launched the Accessible India Campaign (Sugamya Bharat Abhiyan) in 2015 to facilitate barrier-free urban development for Persons with disabilities in three broad domains i.e. Built Environment, Information Technology and Transportation. The Department of Empowerment of Persons with Disabilities (DEPwD), Ministry of Social Justice & Empowerment remains the nodal agency for the successful implementation of the Campaign. It has been a nation-wide flagship campaign to achieve universal access and enablement for persons with disabilities through infrastructure ecosystems involving built environment, transportation and Information & Communication technologies.

Several measures have been taken to spread awareness and drive implementation programmes of access under this campaign. Predominantly, the Accessible India Campaign has shaped the discourse of accessibility into wide ranging possibilities and inter sector responsibilities. The campaign drives the agenda into a holistic vision of accessibility as a norm for Indian living environments.

### 1.3.3 Smart Cities Mission

The Smart City Mission (SCM) of the Ministry of Housing and Urban Affairs launched in June 2015, aimed to transform 100 cities in a span of one five-year plan. The mission focuses on sustainable and

inclusive development, with an idea to look at compact areas, create a replicable model which will act as a lighthouse to other aspiring cities. It caters to the core infrastructural elements and provisions like Efficient urban mobility and public transport, affordable housing (especially for the poor), Robust IT connectivity and digitalization, Good governance (especially e-Governance and citizen participation), safety and security of citizens.

Many innovative projects including Sensory Park for persons with disabilities in Chandigarh, Chennai, Visakhapatnam, a Multi Sports Centre in Bhagalpur, Barrier free stadium in Varanasi; Smart roads in Belagavi, Kanpur, Jaipur and Nashik; Smart pedestrianized roads in Chennai etc. have adopted the principles of universal design in their project formulation.

The Smart City Mission anchors the idea of human centric approaches keeping in view the Indian diversity and technological progress. Cities with greater inclusion will pave way for smarter futures and a more public friendly environment. In the future, Indian urban cities need to further incorporate accessibility perspectives in various stages of city scale implementation of infrastructure projects.

### **1.3.4 National Policy on Elderly**

The National Policy for Elderly, 2011 values “an age-integrated society” and intends to strengthen integration between generations, facilitate interaction between the old and the young as well as strengthen bonds between different age groups. It believes in the development of a formal and informal social support system to strengthen the capacity of the family to take care of senior citizens, and they continue to live in the family. It also attempts to incorporate the action

points as highlighted in the “Madrid Plan of Action and Barrier Free Framework”. It works towards an inclusive, barrier-free and age-friendly society.

The policy brings the concerns of older persons, especially older women, into the national development debate with priority to implement mechanisms already set by governments and supported by civil society and senior citizens associations. It also supports promotion and establishment of senior citizens associations, especially amongst women. It also focuses on the promotion of the concept of “Aging in Place” through accessible housing, income security and home care services, old age pension and access to healthcare insurance schemes and other programmes and services to facilitate and sustain dignity in old age.

### **1.3.5 National Policy on Women**

The National Policy on Women 2001 provisions gives special attention to the needs of women with regard to providing drinking water, sewage disposal, toilet facility, sanitation within acceptable reach of the household and incorporation of a gender lens to housing policies and provision of shelter. It also advocates provisions of support services for women like child care facilities at workplaces and educational institutions.

### **1.3.6 National Policy on Children**

National Policy on Children, 2013 strengthens the need for affordable and accessible quality education and incorporation of age-specific initiatives for safe spaces for play, sports, recreation, and leisure.

UN-CRPD, UN-Safe cities, Madrid Plan of Action and Barrier Free Framework, Age-Friendly Cities (WHO), Beijing Declaration

and Platform for Action, Child Friendly city initiative (UNICEF) have been some of the other commitments focusing on the need for inclusive and universally accessible urban development. India has been committed to all the international treaties and has been working towards mainstreaming inclusion into urban policies and planning.

## **1.4 International Policy Perspectives**

Globally, several initiatives have been launched over the years towards an inclusive development and sustainable urban futures. Some of the key international policies that are oriented towards equity, access and inclusion for all, are represented below to provide an insight.

### **1.4.1 UN Convention for Rights of Persons with Disabilities, 2007**

At a global level landmark initiatives like the UN Convention for the Rights of Persons with Disabilities have brought the world together towards inclusion of Persons with Disabilities by all means. Amongst one of the early signatories, India ratified the United Nations Convention on the Rights of Persons with Disabilities (CRPD) in the year 2007.<sup>26</sup>

The purpose of the present Convention is to promote, protect and ensure full and equal enjoyment of all human rights and fundamental freedoms by all persons with disabilities, and to promote respect for their inherent dignity. Persons with disabilities include those who have long-term physical, mental, intellectual or sensory impairments which in interaction with various barriers may hinder their full and effective participation in society on

an equal basis with others. Article 3 of the UNCRPD guides the following general principles as its foundation:

- a. Respect for inherent dignity, individual autonomy including the freedom to make one's own choices, and independence of persons;
- b. Non-discrimination;
- c. Full and effective participation and inclusion in society;
- d. Respect for difference and acceptance of persons with disabilities as part of human diversity and humanity;
- e. Equality of opportunity;
- f. Accessibility;
- g. Equality between men and women;
- h. Respect for the evolving capacities of children with disabilities and respect for the right of children with disabilities to preserve their identities

Accessibility for all in built environments would remain one of the critical ways to achieve the visions of achieving an inclusive society and the goals of UNCRPD.

### **1.4.2 The New Urban Agenda**

The New Urban Agenda represents a shared vision for a better and more sustainable future - one in which all people have equal rights and access to the benefits and opportunities that cities can offer, and in which the international community reconsiders the urban systems and physical form of our urban spaces to achieve this.<sup>27</sup>

In the pursuit of a sustainable urban future, the new urban agenda reflects a global commitment to an inclusive

future which is focused on equitable aspects of urban development, ensuring quality of life and environmental safety for all. The concept of accessibility in built environments overlaps several such dimensions of the New Urban Agenda which could steer us towards sustainable futures and a more inclusive world. Harmonised guidelines shares the collective vision of commitments made in the new urban agenda through a focused approach towards accessibility.

### 1.4.3 Sustainable Development Goals

The Sustainable Development Goals have adopted inclusion as an overarching theme. The key focus of Goal 11 is to **“Make cities inclusive, safe, resilient and sustainable.”** The SDG 11 lays down 10 Targets as part of its agenda measured with 15 indicators. The outcome targets include: Safe and affordable housing, Affordable, accessible and sustainable transport systems for all; Inclusive and sustainable urbanization; Safeguard world’s cultural and natural heritage; Reduce the adverse effects of disasters

on people; Reduce the adverse per capita environmental impact of cities; Provide universal access to safe, inclusive and accessible, green and public spaces.

### 1.4.4 Incheon Strategy

The adoption of the 2030 Agenda for Sustainable Development presents an opportunity to leverage the synergies with the Incheon Strategy to “Make the Right Real” for Persons with Disabilities in Asia and the Pacific. Both the Incheon Strategy and the 2030 Agenda are based on the respect for human rights, and take a people centred and gender-sensitive approach to development.

## 1.5 Methodology of Guide Development

The Harmonised Guidelines for Universal Accessibility have evolved through the following methodological process, as listed below. (Refer Fig: 1.3)

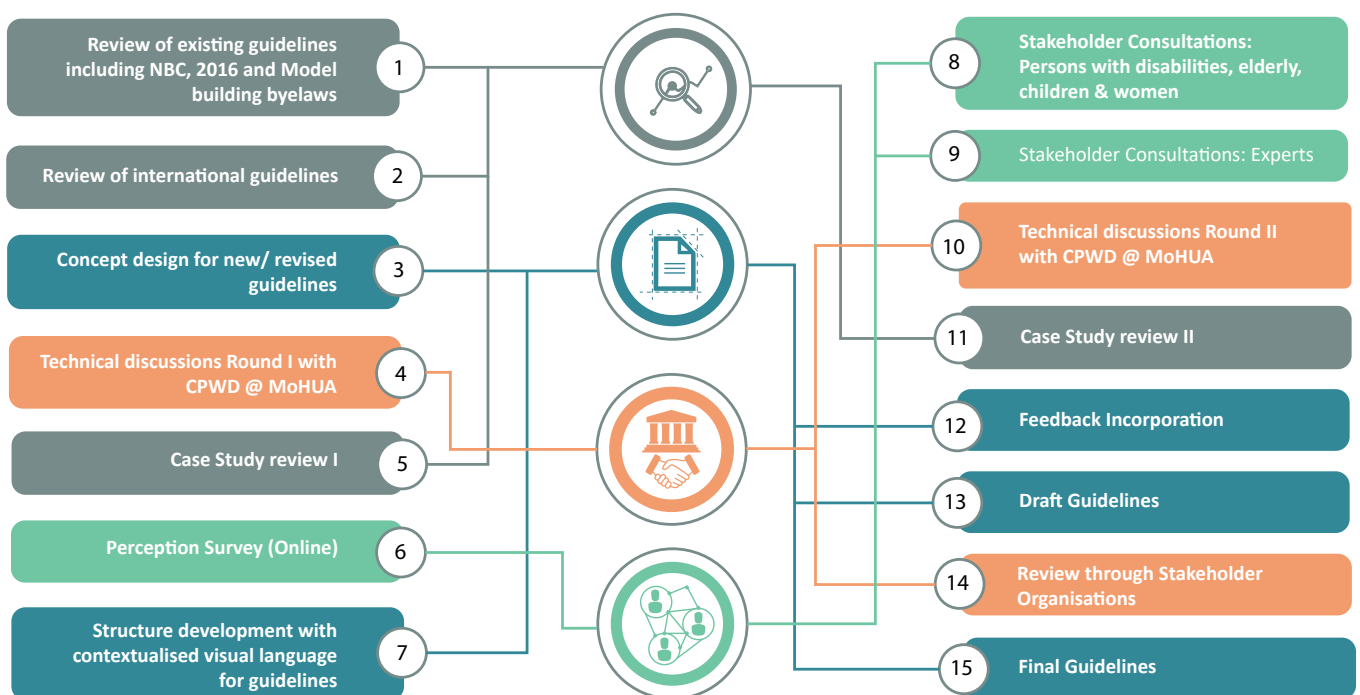


Figure 1.3 Methodology for developing Harmonised Guidelines 2021

### **Phase 1 – State of the art Review**

1. Review of existing guidelines including NBC, 2016 and National Building Bye Laws
2. Review of International Guidelines, such as Singapore, Canada, Germany, Dubai, USA, etc.
3. Identification of key gaps and strategies to overcome
4. Initial discussions with stakeholders about accessibility, implementation perspectives in the Indian context

### **Phase 2 – Perception Survey and Draft Conceptualisation**

1. Online Perception Survey
2. Perception of Accessibility examples from India
3. Review of National and International Case Studies
4. Technical Discussions on Various Accessibility Codes

### **Phase 3 – Stakeholder Participation and Critical Feedbacks**

1. Online Stakeholder Participation and Consultations (Persons with Disabilities and, Elderly)
2. Online Stakeholder Participation and Consultations (Women and Children)
3. Documentation and Incorporation of Feedbacks
4. Perception of Accessibility - examples from India.
5. Review of National and International Case Studies
6. Technical Discussions on Various Accessibility Codes

### **Phase 4 – Final Review and Draft Guidelines**

Development of Draft for Review of Harmonised Guidelines

1. Review through Stakeholder (Expert

Groups)

2. Development of Final Draft of Harmonised Guidelines
3. Issue of Final document for Public Domain

## **1.6 Applications and Stakeholders**

These guidelines have an overarching role to guide the process of implementing accessibility, in addition to specifying the key elements of built environments along with their desirable attributes (physical, dimensional or sensory) for accessibility for all. It is to be well understood that accessibility does not merely restrict towards a one time design conceptualization or an act of accessible construction, but needs to become part of built environment functioning, operations and maintenance as well. This implies responsible agencies (both public and private) taking initiatives towards greater awareness, sensitization of all, in collaboration with those responsible for the built environments. It is further recommended to review and align the procurement policies, tendering procedures, schedule of rates and all other relevant codes used in practice in built environments in order to incorporate accessibility in every aspect. Extensive capacity development of human resources in municipal bodies, development authorities and all other sector specific domains towards accessibility must be conducted regularly and on high priority.

### **1.6.1 Holistic Framework of Application & Implementation**

A holistic framework for application and implementation of accessibility in built environments is being proposed starting from conceptualisation of a project



to realisation of the same and even beyond as shown in Fig: 1.3. It is highly recommended to ensure accessibility as an integral feature of every stage of creating a built environment to truly develop an inclusive experience for everyone.

#### **Stage 1: Planning, Design or Conceptualisation**

This stage implies understanding the design or planning brief, the development of project requirements and the development of final design for implementation. Incorporation of universal accessibility at levels from site planning to detailed working drawings of the project would ensure clearance at this stage.

#### **Stage 2: Procurement, Tendering or Specifications**

Drafting specifications and incorporation of accessible features, materials, details and technologies in a holistic way are required to be done at this stage in Tender documents and construction drawings. Predominantly, a procurement policy of all built environment features, materials, etc. must follow a universal design.

#### **Stage 3: Regulatory Sanctions or Approvals**

Project feasibility or implementation related sanctions and approvals need to ensure accessibility compliance through reviews of project documents including final plans, design drawings and specifications. It would be advisable to also incorporate project management checks for the construction phase of the building.

#### **Stage 4 : Site or Project Implementation**

Site implementation is the final stage of any design which requires regular accessibility quality checks for issuing occupancy certificates. Respective agencies or authorities need to develop standardised protocols in order to ensure accessibility checks for site or project

implementation. The same applies for redevelopment or retrofitting projects of existing built environments.

#### **Stage 5 : Infrastructure Evaluation or Assessment**

Accessibility assessment in the form of access audits or detailed reviews needs to be carried out for all built infrastructure projects in order to make a realistic check on the existing infrastructure and create high benchmarks in accessibility for new infrastructure. These assessments could be carried out as a mandatory Post Occupancy Evaluation of accessibility in built environments before handing in the occupation of the buildings.

#### **Stage 6 : Maintenance, Operations or Management**

After the realization of an accessible infrastructure, the experience of accessibility in built environments further depends on how well it's maintained, operated and managed. This requires sensitization of manpower, development of efficient protocols for accessibility and role of embedded and assistive technologies for ease of access, safety and agile response to diverse users. Accessibility in building management and operations may include domains like security services, sanitation services, mobility services, emergency services, etc.

### **1.6.2 Stakeholders**

To achieve the long term goals of universal accessibility and sustainability through inclusive and accessible practices in built environments, a continued engagement with diverse stakeholders is of high significance. Urban futures and built environments are not merely created by construction as an activity but require a wide-range of steps, starting from policy up to planning and design, in order to implement and enforce compliance with regard to accessibility, which requires

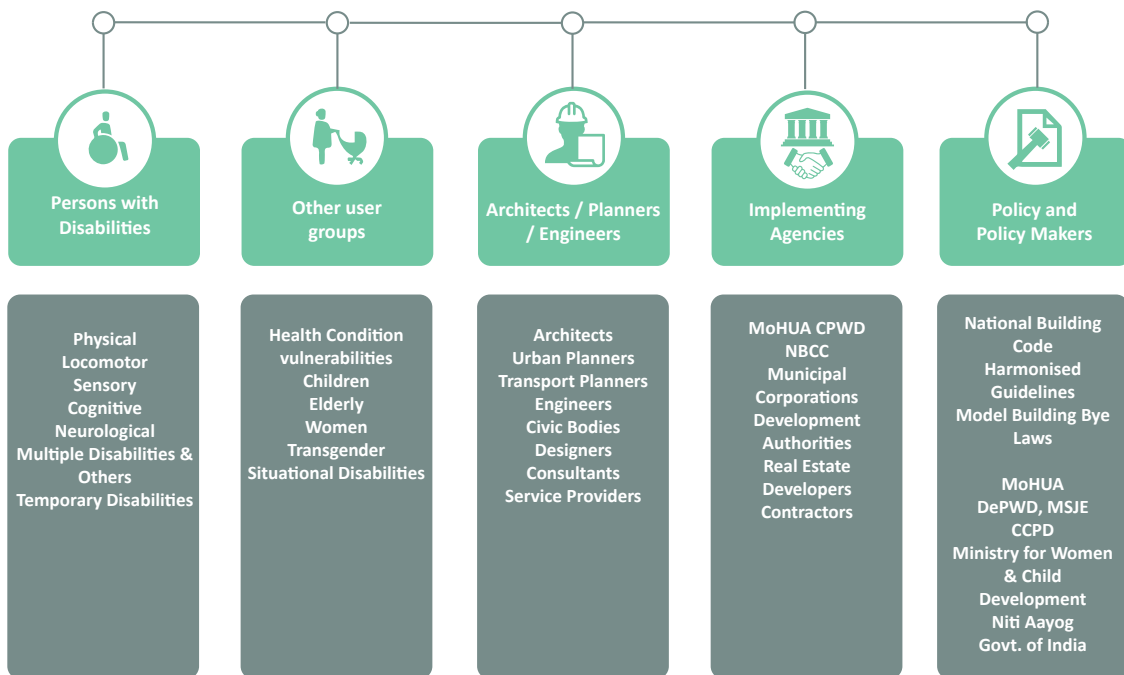


Figure 1.4 Stakeholder Framework

seamless incorporation at all levels.

A constant engagement with stakeholders from levels of awareness to levels of advancing the universal accessibility requires training and capacity development programmes along with grounded implementation involvements.

The stakeholders who can play a vital role in transforming these guidelines into an inclusive urban reality shall include policy makers, architects, planners, engineers, designers, real estate developers, construction and project management agencies, technology developers, manufacturers, etc. Educational institutions or organisations involved in the discipline of architecture, planning and design as active stakeholders shall play a vital role in contributing to accessibility as a guiding principle in future practices of built environments.

In addition to the above, diverse user group engagements involving persons with disabilities, children, elderly,

women, transgender population groups, persons with health concerns or other vulnerabilities, etc. shall pave a participatory approach for stakeholders to contribute towards accessibility in our built environments. It is however anticipated that every citizen, layperson could use these guidelines to be made self aware or for purposes beyond to advocate, guide or sensitize others towards the role of accessibility and inclusion in urban futures.

Any built environment involves wide ranging stakeholder groups towards its creation and successful usage. As stakeholders, key decision or policy makers, built environment professionals like architects, planners, engineers, designers and all other from the construction industry, are involved. It is however anticipated that every citizen, layperson could use these guidelines to be made self aware or for purposes beyond to advocate, guide or sensitize others towards accessibility in built environments.

## 1.7 Guiding Philosophy

The Harmonised guidelines have been envisioned with a key guiding philosophy of universal design contextualized towards the Indian perspectives of built and socio cultural environments. These guidelines intend to bring a shift in our approach, attitudes and deliverables to built environment conceptualization, retrofitting and implementation. A clear shift from a minimum compliance approach to an approach for creating best practices of universal design and inclusion is what this document intends as its core spirit. The guidelines imbibe in their philosophy the idea of responsiveness to the needs of diverse users including persons with disabilities, women, elderly, children and several other vulnerable sections of society with special needs.

The five key pillars of this **philosophy** are

### a. Human Centric

### b. Universal accessibility

### c. Equity & Inclusion

### d. Safety

### e. Participatory

The above philosophy guided the key features to revise and transform the existing harmonised guidelines. The three key features of the guiding approach being viz. bringing a shift from barrier free to universal design approach, evolve visual contextualization and enhance readability towards ease in implementation (Fig: 1.5).

The spirit of this philosophy can be integrated in the built environment by enabling wider choices in access, incorporation of technologies, affordable and customizable designs, developing innovative alternatives and most importantly by educating built environment professionals and users towards a holistic approach to accessibility.

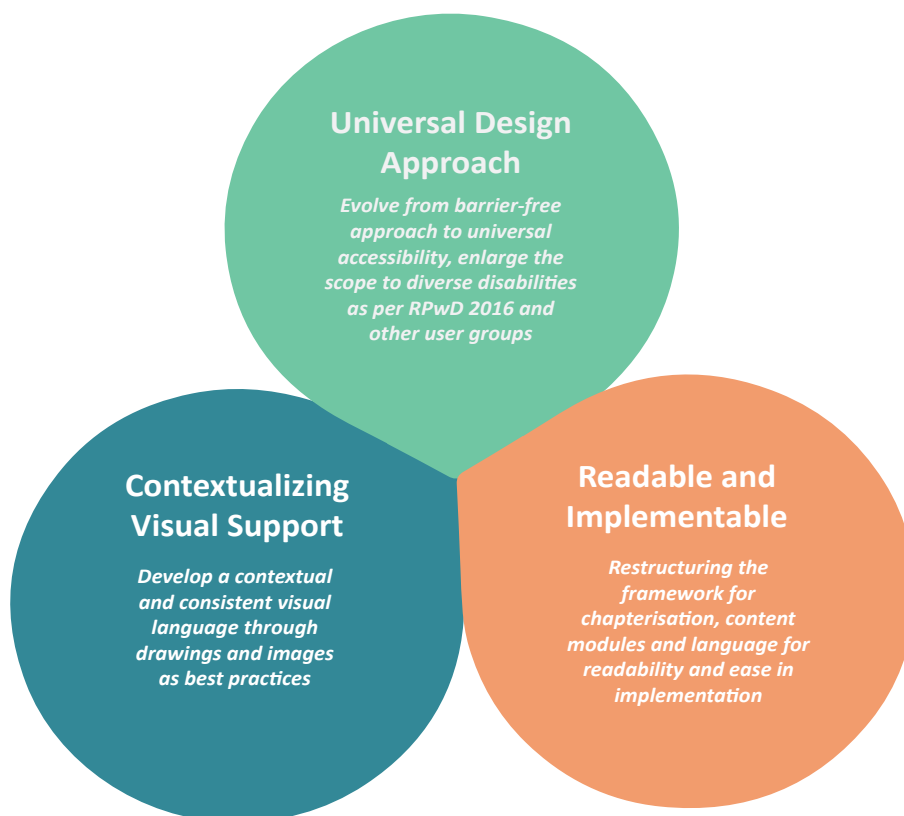
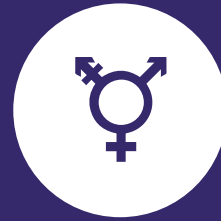
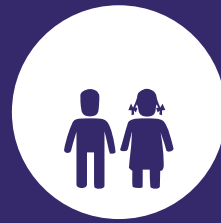


Figure 1.5 Key features of Guiding Approach







# Accessibility, Diversity and Universal Design

- 2.1 Diversity and Inclusion :  
Perspectives to Accessibility
- 2.2 Understanding Universal Design
- 2.3 Understanding Disability & Diversity
- 2.4 Accessibility Needs for Persons with  
Disabilities
- 2.5 Accessibility Needs for Diverse User  
Groups
- 2.6 Barriers to Accessibility in Built  
Environment
- 2.7 Basic Anthropometry and Space  
Allowances
- 2.8 Accessibility Framework for Built  
Environment







*Accessibility allows us to tap  
into everyone's potential*

*-Debra Ruh*





# ACCESSIBILITY, DIVERSITY AND UNIVERSAL DESIGN

# 2

In reference to the quote by Debra Ruh, it would be ideal to understand that accessibility plays an enabling role in human lives. Body limitations, cognitive challenges or personal situations need not limit one's independent functioning or social participation, if the living environments provide accessibility in a holistic way. It's important to understand that we are all temporarily able bodied individuals and may go through body, sensory or cognitive challenges in different phases of life. Access to information, infrastructure and services then becomes a basic human

requirement to sustain life. Accessibility, therefore need not be merely projected a basic human right but also an integral responsibility of our environments that host human diversity and its variety of functions.

Accessibility is a multi layered, multi dimensional and multi contextual aspect of built environment. Amidst various existing definitions of the term, these guidelines specify the key framework for accessibility into three key dimensions i.e. Information, Infrastructure and Services / Management (Fig: 2.1).

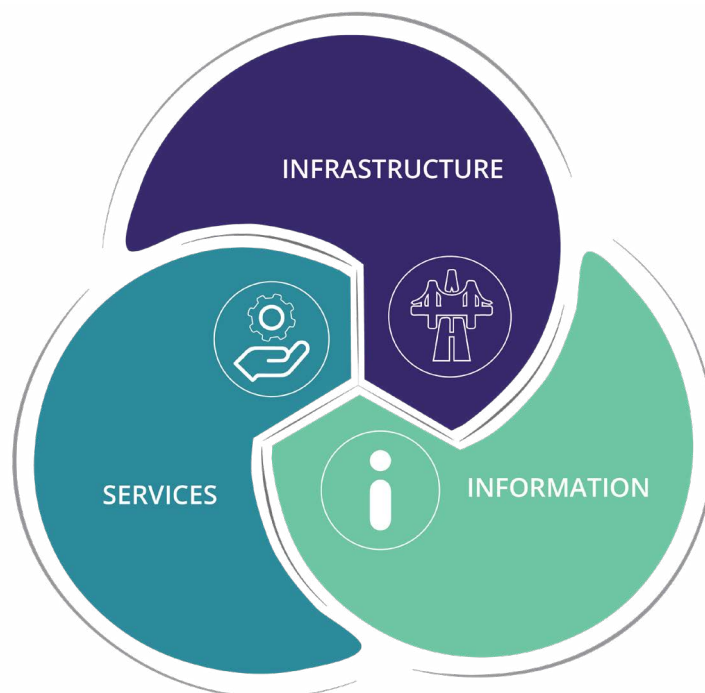


Figure 2.1 Accessibility framework for Built Environment



Accessibility is basic to human existence, ranging from access to basic living requirements, or to move or functionally perform in diverse living environments. On the contrary, inaccessibility poses immense challenges to human lives, self esteem and human dignity alongwith posing an immense cost of exclusion from society, which would be hard to evaluate in tangible terms.

Accessibility is not merely a physical attribute of built environment but also a sensory, cognitive and multi faceted impactful need of all humans including those with disabilities. The unique Indian context provides specific aspects of its culture and diversity that it's vital to bring certain sense of uniformity in the levels of accessibility in the built infrastructure of the nation across all urban towns and cities. Assistive technologies and new advancements pose new avenues to enhance individual accessibility for diverse user groups.

### **2.1 Diversity and Inclusion : Perspectives to Accessibility**

India is uniquely positioned because of its diversity in culture, traditions, geographic locations, climatic zones and everything else originating from them be it languages, folk arts, living environments, etc. Amidst such perspectives of diverse coexistence of majority world populations, diversity across its population also needs to be seen from a perspective of age, ability, gender, health condition, economy and various other aspects of human vulnerabilities.

Inclusion and reasonable accommodation for all the above contexts including persons with disabilities, children, elderly, women, transgender, health conditions, etc. in our built environments remains critical to provide dignified living and inclusive social participation to all. The

need to address these concerns can't be overemphasized in today's context when our demographic projections into a future reflect ageing, ailing and increased percentages of disabilities as a regular phenomenon

### **2.2 Understanding Universal Design**

#### **2.2.1 Definitions**

Universal Design is an approach, philosophy and a guiding code that aims to provide a constructive and inclusive mindset to respond to the needs of diverse population types including all and free from any form of stigma on the basis of age, gender, ability or any other human attribute. Coined as a term by a well known American Architect, Ronald L.Mace, the earliest definition of Universal Design is:

---

***“The design of products and environments to be usable by all people, to the greatest extent possible, without the need for adaptation or specialized design.”***

***Ronald L.Mace***

---

Over the years, Universal Design as a concept and approach has further evolved and grown resulting in the creation of Eight Goals beyond the well known Seven Principles. A new and revised Definition of Universal Design states:

---

*“Universal Design as a process that enables and empowers a diverse population by improving human performance, health and wellness, and social participation.”*

*Steinfeld and Maisei, 2012*

---

Besides these well founded international origins of Universal Design as an approach, a group of Indian experts also formulated and created a theory and philosophy in 2011, popularly known as Universal Design India Principles (UDIP). The idea was to contextualise and advance Universal Design for Indian perspectives. Universal Design continues to evolve and expand its perspectives, understandings and implementation in time, keeping the core values of accessibility and inclusion of everyone as larger goals.

It is crucial to also understand that the application of universal design approach, right from the design inception stage of projects eliminates the need to make changes or retrofits to built environment at a later stage for specific adaptations.

Elaborate understanding of Universal Design is discussed in the following sections.

### **2.2.2 The Seven Principles of Universal Design<sup>5</sup>**

The seven (07) Principles of Universal Design were developed in 1997 by a

working group of architects, product designers, engineers, and environmental design researchers, led by Architect Ronald Mace. The Seven Principles alongwith their guidelines are mentioned below:

#### **Principle 1 Equitable Use**

The design is useful and marketable to people with diverse abilities.

Guidelines –

- a. Provide the same means of use for all users: identical whenever possible; equivalent when not.
- b. Avoid segregating or stigmatizing any users.
- c. Provisions for privacy, security, and safety should be equally available to all users.
- d. Make the design appealing to all users.

#### **Principle 2 Flexibility in Use**

The design accommodates a wide range of individual preferences and abilities.

Guidelines –

- a. Provide choice in methods of use.
- b. Accommodate right- or left-handed access and use.
- c. Facilitate the user’s accuracy and precision.
- d. Provide adaptability to the user’s pace.

#### **Principle 3 Simple and Intuitive Use**

Use of the design is easy to understand, regardless of the user’s experience, knowledge, language skills, or current concentration level.



Figure 2.2 The Seven Principles of Universal Design

Guidelines –

- a. Eliminate unnecessary complexity.
- b. Be consistent with user expectations and intuition.
- c. Accommodate a wide range of literacy and language skills.
- d. Arrange information consistent with its importance.
- e. Provide effective prompting and

feedback during and after task completion.

**Principle 4 Perceptible Information**

The design communicates necessary information effectively to the user, regardless of ambient conditions or the user's sensory abilities.

Guidelines –

- a. Use different modes (pictorial, verbal, tactile) for redundant presentation of essential information.
- b. Provide adequate contrast between essential information and its surroundings.
- c. Maximize “legibility” of essential information.
- d. Differentiate elements in ways that can be described (i.e., make it easy to give instructions or directions).
- e. Provide compatibility with a variety of techniques or devices used by people with sensory limitations.

#### **Principle 5 Tolerance for Error**

The design minimizes hazards and the adverse consequences of accidental or unintended actions.

Guidelines –

- a. Arrange elements to minimize hazards and errors: most used elements, most accessible; hazardous elements eliminated, isolated, or shielded.
- b. Provide warnings of hazards and errors.
- c. Provide fail safe features.
- d. Discourage unconscious action in tasks that require vigilance.

#### **Principle 6 Low Physical Effort**

The design can be used efficiently and comfortably and with a minimum of fatigue.

Guidelines –

- a. Allow user to maintain a neutral body position.

- b. Use reasonable operating forces.
- c. Minimize repetitive actions.
- d. Minimize sustained physical effort.

#### **Principle 7 Size and Space for Approach and Use**

Appropriate size and space are provided for approach, reach, manipulation, and use regardless of user’s body size, posture, or mobility.

Guidelines –

- a. Provide a clear line of sight to important elements for any seated or standing user.
- b. Make reach to all components comfortable for any seated or standing user.
- c. Accommodate variations in hand and grip size.
- d. Provide adequate space for the use of assistive devices or personal assistance.

### **2.2.3 Universal Design : The Eight Goals**

In 2012, the Center for Inclusive Design and Environmental Access at the University of Buffalo expanded the definition of the principles of universal design to include social participation, health and wellness. Rooted in evidence based design, the eight goals of universal design were also developed as follows:

#### **1. Body Fit**

Accommodating a wide range of body sizes and abilities.

#### **2. Comfort**

Keeping demands within desirable limits of body function and perception.

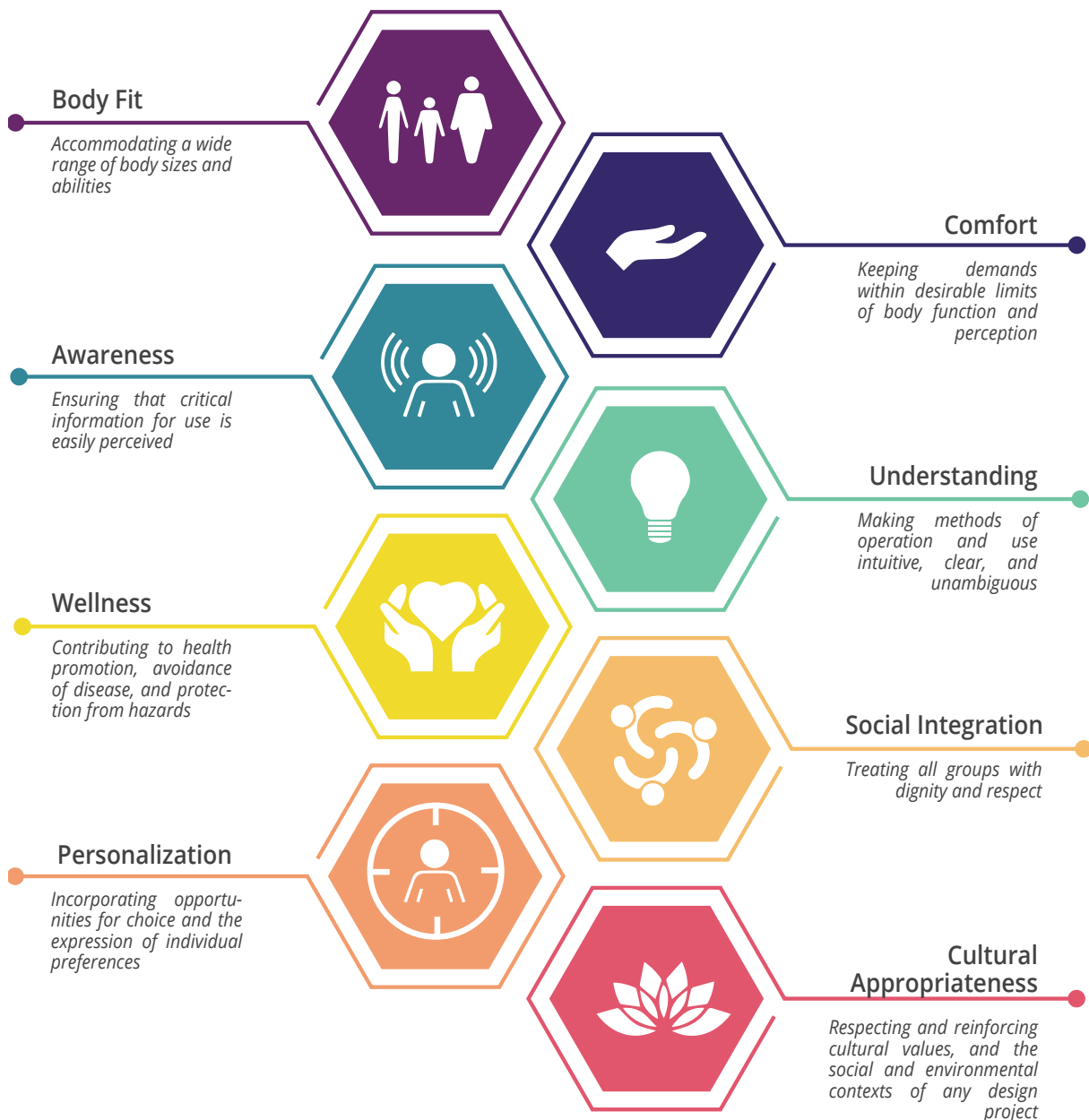


Figure 2.3 Universal Design: The Eight Goals

**3.Awareness**

Ensuring that critical information for use is easily perceived.

**4. Understanding**

Making methods of operation and use intuitive, clear, and unambiguous.

**5.Wellness**

Contributing to health promotion, avoidance of disease, and protection from hazards.

**6. Social Integration**

Treating all groups with dignity and respect.

**7.Personalization**

Incorporating opportunities for choice and the expression of individual preferences.

**8. Cultural Appropriateness**

Respecting and reinforcing cultural values, and the social and environmental

contexts of any design project.

The first four goals are oriented to human performance: anthropometry, biomechanics, perception, cognition. Wellness bridges human performance and social participation. The last three goals address social participation outcomes.

#### **2.2.4 Universal Design India Principles : The Five Principles<sup>19</sup>**

The UDI principles are stand alone universal design ideologies that focus on Indianness and inclusivity as they relate to age, gender, disability, caste, class, religion, poverty and urban/rural background. UDI principles neither make any connection nor build on the seven Universal Design Principles. They recognize the overarching importance of seven Principles and extend it to Five Principles to contextualise their relevance to India. They are:

##### **1. Equitable (Samaan)**

The design is fair and non-discriminating to diverse users in the Indian context.

Guidelines -

1. Avoid prejudices against people of all ages, gender, disability, sizes, caste, class and religion.
2. Consider different capabilities of users and build in many levels of engagement.
3. Provide choices in access and use through flexibility and customization.
4. Allow personalization through inclusion of adjustable and adaptable options.
5. Provide equality in challenge, opportunity and energy requirement.

##### **2. Usable (Sahaj)**

The design is operable by all users in the Indian context.

Guidelines -

1. Provide independence, comfort, safety and support during use.
2. Facilitate access, operation and convenience by diverse users.
3. Include adaptations for those experiencing difficulty in use.
4. Provide clarity in use, operation and maintenance to minimize instruction and avoid confusion and error.
5. Adopt simple means to overcome complex operations.

- Follow cultural norms to address user expectations.
- Offer multi-sensory feedback to point in the right direction.
- Build in intuitive operation and innate understanding of problems.
- Allow easy adaptation to facilitate use by people with diverse abilities.
- Prevent costly mistakes and unintended consequences from misuse.

##### **3. Cultural (Sanskritik)**

The design respects the cultural past and the changing present assist all users in the Indian context.

Guidelines -

1. Maintain social and traditional qualities in design.
2. Include Indian idioms to make historic and social connections.
3. Present in many languages for inclusive comprehension.
4. For all castes and society levels.
5. Respond to the local context and conditions.

6. Employ appropriate technology to match user expectations.

#### 4. Economy (Sasta)

The design respects affordability and cost considerations for diverse users in the Indian context. However, it does not imply 'Sasta' as a compromise on quality and adequacy. Rather it intends to promote economic value and reasonable accommodation as a guiding principle.

Guidelines –

1. Ensure affordability, durability and maintainability.

2. Use local materials for energy savings and cost effectiveness.

3. Focus on low unit cost through wide distribution.

4. Adopt a modular approach to offer choice in features and price range.

#### 5. Aesthetics (Sundar)

The design employs aesthetics to promote social integration among users in the Indian context.

Guidelines –

1. Employ aesthetics to enhance universal appeal and use.



Figure 2.4 Universal Design India Principles <sup>19</sup>

2. Allow personalised aesthetics through flexibility, adaptability and modularity of color, form, texture and interaction.
3. Employ appearance to inform use and safety.
4. Bridge wide range of meaning and comprehension gaps.

Universal Design India Principles paves a context specific direction towards achieving greater accessibility and inclusion of diverse population groups in Indian contexts. This may include diverse population contexts, low resource settings, diverse geographical and regional locations alongwith new technological paradigms.

### 2.3 Understanding Disability & Diversity

India is a host to majority population of the world which is uniquely diverse, distinct and pluralistic in its spread and existence. Therefore, contextual studies have to be initiated to understand the specific needs of this wide range of

population which may have its own uniqueness when compared to other global contexts.

As contextual stakeholders of built environments, it is important to value and understand the specific needs of diverse user groups sensitively. This forms the first step towards achieving better accessibility and greater inclusion in our living environments. Universal design thinking advocates this as a core principle to acknowledge diversity and sensitively map their needs while planning built infrastructures. This section broadly has two parts viz. one that profiles diverse user types and their special characteristics and second that maps built environment needs.

Age, ability, gender form the crucial parameters of population diversity that require sensitivity and interventions in our built environments and everyday lives to create more accessible features and inclusive spaces for all. Table 2.1 maps the diverse human typologies alongwith their special characteristics, which is adapted from the Enabler Model.<sup>23</sup>







































Figure 2.5 Understanding Disability & Diversity<sup>23</sup>






































Chapter 2: Understanding Accessibility

Table 2.1 Understanding Disability & Diversity<sup>23</sup>

Special Characteristics Requiring Attention	User Group				
	Infants and Children (up to 8 years old)"	Expectant Mothers	Older Persons (more than 50 years old)	Persons with Hearing impairments	Persons with Visual Impairments
Difficulty in Interpreting Information					
Poor or Complete Degradation of Sight					
Poor or Complete Degradation of Hearing"					
Prevalence of Poor Balance					
Prevalence of Poor Coordination and Orientation					
Poor or Inability in Handling					
Poor or Inability in using Upper Extremities					
Poor or Inability in using Lower Extremities					
Limitations of Stamina					
Limitations of Strength					
Vertically and Horizontally Challenged (in terms of height and weight)					
Require Physical Assistance or Supervision					
Require Family-Friendly Facilities					
Use of Movement Aids					
Others		Increased visits to toilet.			Use of walking cane to detect obstructions

Harmonised Guidelines and Standards for Universal Accessibility in India 2021

User Group					
Cognitive Impairments	Persons with Neurodiverse conditions	Persons with Physical Injuries (upper and lower body)	Wheelchair Users	Health Condition (Cardiac, Terminal Illness, Temporary Disabilities, etc.)	Situational Contexts ( Luggage, Weather, Disaster, Technology adaptation)
					
					
					
					
					
					
					
					
					
					
					
					
					

## 2.4 Accessibility Needs for Persons with Disabilities

Accessibility needs in the context of built environments for diverse user groups provide a specific yet generic perspective towards creating enabling built environments for all. While the following chapters specify details of various elements of built environments, this section provides a broad perspective on the various attributes of accessibility for persons with disabilities.

### 2.4.1 Physical Disabilities

Persons with disabilities too exist in diverse forms and with varying degrees of disabilities. Certain disabilities of physical nature may be visible through body structures while several disabilities impair the invisible body functions which may require adaptation at various levels in built environments. Some of the common accessibility needs for diverse disability types in built environments are stated below.

#### a. Ambulant Disabilities

This includes persons with lower limb difficulties which may be temporary or permanent in nature leading to requirements for body support, slow movement, etc. Persons with ambulant disabilities may use assistive devices like crutches, cane, walking frames, rollators, etc. while some may move without assistive devices. Built environments need to accommodate their needs, through some of the following features:

- Adequate Parking spaces for adapted scooters, tricycles or other assistive devices
- Grab rail support in circulation spaces for movement.
- Nonslip surfaces alongwith periodic maintenance of walking spaces.

- Low kerb heights and level crossings in street environments
- Provision of resting spaces in public spaces, side walks, etc.
- Providing adaptive or accessible washroom facilities with support features like grab rails, hooks, space to keep assistive devices like cane, crutches, etc.

#### b. Non ambulant disabilities / Wheelchair users

Non ambulant disabilities may occur as a result of various reasons, either naturally or due to an accident. Persons with non ambulant disabilities may use wheeling devices like wheelchairs (manual, powered, etc.) or tricycles or ground mobility devices as assistive technologies for their mobility needs. Negotiating levels in built environments remains a critical challenge to their accessibility and safety needs. The following features may enhance accessibility:

- Parking spaces with wider access and circulation
- Step free and wider entrances with adequate landing spaces for wheelchair or powered chair maneuvering, etc.
- Adaptive spaces for wheelchair users in outdoor and indoor environments.
- Provision of ramps with gentle gradient, maneuvering spaces, edge protections, grab rails and non slippery surfaces.
- Accessible elevator with maneuvering spaces and appropriate level differences.
- Clear space of 900 mm minimum for all circulation areas like corridors, doors, street bollards, etc. to accommodate a wheelchair user.
- Low height controls for easy reach in room interiors, elevators, etc.

- Knee space clearances below counters, lavatories, etc. in washrooms, reception counters, etc.
- Providing accessible washrooms and other accessible facilities like parking.
- Sturdy and non slippery flooring material allowing easy maneuverability of the wheelchair and other mobility devices.
- Emergency alarms and evacuation services with access to public assembly areas

### **c. Upper Limb Extremities**

Upper limb extremities may result from consequence of various health conditions or life situations. This may pose challenges to performing activities involving lifting, reaching, gripping, etc. Built environments could sensitively respond to their accessibility needs through the following accessibility approaches or support:

- Easy to operate doors or other interior features
- Provision of lever type handles in openable systems (doors, cabinets, etc.)
- Grab rail supports in circulation spaces
- Foot operated controls like latches, switches etc. in doors or windows
- Avoiding sharp corners and edges wherever shoulder or body push features are required
- Flexible furniture systems for ease in body adjustments in absence of upper limb limitations
- Provision of support surfaces at various heights to keep belongings
- Non slip surfaces, especially in wet areas like washrooms, etc.

### **2.4.2 Visual Impairments**

Visual impairments include various forms of sight related disorders ranging from low vision to peripheral loss of vision to partial or complete blindness, etc.

#### **a. Low Vision**

People with partial loss of vision can usually find it very difficult to navigate in and around the built environment, especially in unfamiliar settings. While excessive contrast can create problems of glare, inadequate contrast can make it difficult for persons with low vision to discern objects or details in the environment.<sup>2</sup>

- Adequate visual contrast in level changes and surfaces
- Adequate illumination
- Larger Font size in signage
- Effective colour combinations keeping in mind the needs of the colour blind
- Glare free light
- High resolution (readable characters) for example with LCD
- Use of assistive technologies like screen magnifiers, screen readers, text to speech or voice recognition software, etc.
- Obstruction and Protrusion free paths for movement
- Avoid slippery surfaces

#### **b. Blindness**

- High contrast environments
- Provision of Tactile Pavers guides people with visual impairment to move independently.
- Provision of safe and level pedestrian crossings in street environments
- High contrast color markings at the edges wherever there are level

changes.

- Braille plates as information systems to be integrated with elements like handrails in staircase / ramps or grab rails in circulation spaces.
- Provision of Multi-lingual signage alongwith Braille.
- Tactile floor plan or tactile models with consistency to be provided for in built environments especially public buildings, transportation hubs, etc.
- Use of Digital Signage system with Audio-Video public announcements.
- Good acoustic treatment indoors which does not distort sound.
- Radio Frequency Identification systems and new state of the art technologies for enhanced sensory communication may be employed to enhance accessibility in mobility and other functional spaces of built environments.
- Use of sensory landscapes, micro climate features, soundscapes using water, etc. as features in built environment for ease in navigation.
- The handrails at staircase / ramps should have information of Floor Number in Braille.

### 2.4.3 Hearing Impairment

Hearing quality is crucial for communication of information or detection of hazards while moving through a range of built environments especially in high traffic zones or environments with high background noise. Hearing loss (HL) is classified as Mild for HL in range 26 to 40 db, Moderate for HL range 41 to 55, moderately severe from 56 to 70 db, Severe for 71 to 90 db and profound HL for range 91 db or more. Considering a range of HL across individuals with hearing impairments, built environments

need to reinforce their visual order, communication systems especially for emergency services and evacuation to ensure that persons with hearing impairments are not neglected. Built environment spaces and infrastructure needs to facilitate oral -aural or sign language communication through its operations and services to be inclusive to persons with hearing impairments. A few of the accessibility needs in this context are stated below:

- Audio alerts can be substituted with visual alerts.
- Users should be able to configure the frequency and volume of audible cues wherever made available.
- Use of efficient wayfinding system which allows a user to reach a destination independently.
- Use of Digital Signage system with Audio-Video public announcements.
- Good acoustic treatment indoors which does not distort sound and enhances its quality.
- Minimising Background noise especially in transportation systems, street environments and public spaces.
- Assistive technology supports like Headphones, Hearing aids, Ear implants (Cochlear implants) for individuals
- Devices like Induction Loop Systems, Infrared transmission systems (IR), Radio transmission systems (FM) may be employed as Assistive Technologies in built environment.

### 2.4.4 Speech Impairment

- Facilitation of two way communication to minimize barriers to hearing low and indistinct speech.
- Use of appropriate wayfinding,

signage systems.

- Use of efficient wayfinding system which allows a user to reach a destination independently.
- Use of visual icons or pictograms in addition to text characters.
- Use of Digital Signage system with Audio-Video public announcements.

#### **2.4.5 Cognitive Impairments**

- Provision of physical and sensory cues such as touch, sound, smell and tactile or audible information.
- Simplified designs, layouts for ease in mind mapping.

#### **2.4.6 Neurodiversity**

Neurodiversity refers to the wide range of differences in the manner in which the human brain processes information. It refers to alternative thinking styles, such as Dyslexia, Autism spectrum condition, Attention Deficit Hyperactivity Disorder (ADHD), Dyspraxia, Dyscalculia, etc.

- Wider aisle widths with legible and neat visual order in built spaces.
- Visual comfort through adequate lighting.
- Different light intensities have an impact on how every person handles a task. It can have a greater impact when neurodiversity is a factor, sometimes making it extremely difficult to complete tasks unless a suitable degree of visual comfort is provided.
- For neurodiverse building occupants, excessive noise - or even certain types of noises - can elevate stress levels and disrupt (or even halt) productivity. Flooring can be used to manage excessive noise.

- Soft landscapes around level changes to prevent injury in case of slips or falls.
- Grab rail support in circulation spaces.
- Avoiding sharp corners in built environment or its internal furniture.
- People with neurodiversity may process navigational information in a non-traditional way, so standard wayfinding may not be sufficient. Additional measures may include lighting and flooring effects.

#### **2.4.7 Multiple Disabilities**

Persons with multiple disabilities may reflect a combination of the above mentioned needs in built environments in addition to specific support for their functioning and performing activities of daily living.

### **2.5 Accessibility Needs for Diverse User Groups**

Human abilities vary in diverse ranges of physical, sensory and mental capabilities. Built environments need to be mindful to accommodate a widest possible range of human abilities through design of various elements, features and overall services as part of it. For better understanding, the accessibility needs of some diverse user groups are listed below:

#### **2.5.1 Infants, Toddlers and Children**

Infants, toddlers and children in their early life stages require special care and support in built environments, including spaces for family members and play areas. It is pertinent to include and accommodate for children with special needs through therapeutic play areas and systems.

- Family friendly features in public



## Chapter 2: Understanding Accessibility

areas, urban spaces, transportation hubs.

- Baby changing stations to be made available in both Female and Male washrooms, lactation rooms, creche support in built environments like work places, etc.
- Child friendly facilities in all public spaces, etc.
- Walkable, friendly, and wide kerb ramps in street infrastructure to be provided for using baby prams.
- Children play areas in neighborhoods with provision of soft landscapes.
- Therapeutic play areas or parks for children with special needs.
- Adequate information and signage support for various child friendly facilities in built environment.
- Low height basins, mirrors, faucets, counters, etc. to accommodate children of various age groups.

### 2.5.2 Women

Built environment accessibility needs for women should consider diverse age groups, diverse cultural contexts and diverse life situations in which women operate. As an expectant mother, as a working professional or as an elderly mother, built environments require to be sensitive to gender specific needs while retaining an inclusive and safe character to our environments. Diverse forms of women clothing (saris, salwar kameez, etc.) and footwear (heels, kolhapuri chappals, etc.) require a certain orientation to built environment elements and their detailing.

- Uniform and low kerb heights and level crossings in sidewalks
- Perforated pavers or grass pavers should be avoided as they pose

barriers or challenges for women wearing different kinds of shoes like shoes with heels and Kolhapuri Chappals etc.

- Well maintained pathways, free from uncobbled surfaces to avoid any challenges for expectant mothers in public spaces or in transition from public transport facilities.
- Provision of lactation or feeding rooms in organisations / work places and transportation hubs.
- Child protection seats in public washroom facilities for women.
- Wider footpaths to enable the caregiver role of women or families accompanying young children, elderly parents or carrying bags full of supplies for their homes.
- Provision of resting spaces and other public amenities for expectant mothers in public spaces.
- Well illuminated street and public space environments.

### 2.5.3 Transgender

Inclusion of transgender populations in built environments requires to sensitively respond to the following aspects in addition to most of the above mentioned accessibility needs, such as:

- Inclusion of Transgender through provision of proper signage and visual information wherever shared facilities need to be provided in public spaces.
- Provision of unisex washrooms or gender neutral washrooms to be made available in Public Spaces, Transportation hubs, etc.

### 2.5.4 Elderly

Ageing as a human life stage integrates

several dimensions of human diversity with usual challenges of loss of mobility, dexterity, hearing, sight, memory, strength or stamina. Elderly citizens are prone to falls and slip accidents in wet areas like the washrooms or floors under maintenances. The phenomenon of ageing induces multiple forms of physical, sensory and cognitive challenges which have to be addressed in built environments that not only minimize physical effort, but also render services with care, priority and inclusion. The accessibility needs listed below must be considered while planning and designing built environments.

- Provision of supporting element in built environment like Grab rails, Nonslip surfaces, adequate colour contrast in level changes.
- Use of efficient wayfinding system which allows a user to reach a destination independently.
- Provision of priority queuing systems
- Provision of ramps with gentle gradient, accessible elevator access and appropriate level differences.
- Large and readable fonts with adequate colour contrast in signage systems.
- Digital signage systems with real time information and audio-video public announcements.
- Adaptive and supportive features like grab rails, high WC seat, etc. in residential and public washrooms.
- Well maintained, non-slippery flooring surfaces.
- Good acoustic treatment indoors which does not distort sound and enhances its quality.
- Providing emergency alarms in private spaces of the elderly which can warn the caregiver, in the event of any

accidents or emergency situations.

- Provision of resting spaces and accessible washroom facilities in public spaces.

#### **2.5.5 Health Conditions (Cardiac, Blood Pressure, Terminal Illness, Post Operative contexts, Temporary Disabilities, etc.)**

Health conditions may be temporary or permanent in diverse human population groups. Contemporary living environments reflect people with cardiac disorders, blood pressure, terminal ailments like cancer, post operative challenges, knee replacements, etc. as part of our societies. Supportive and accessibility elements in built environments would enhance their inclusivity. Some of their needs include:

- Provision of supporting element in built environment like Grab rails, Nonslip surfaces, adequate colour contrast in level changes.
- Provision of ramps with gentle gradient, accessible elevator access and appropriate level differences.
- Use of efficient wayfinding system which allows a user to reach a destination independently.
- Use of Digital Signage system with Audio-Video public announcements.
- Good acoustic treatment indoors which does not distort sound and enhances its quality.
- Provision of resting spaces and accessible washroom facilities in public spaces.
- Grab rail support in staircases, ramps, corridors, etc.
- Minimum level changes or level surface routes.

## 2.6 Barriers to Accessibility in Built Environments

Anything that limits access to daily living functional activities or a dignified inclusion in built environments could be considered as a barrier to accessibility. Predominantly, the barriers to accessibility can be classified in four distinct typologies viz. Information & Communication, Built Infrastructure & Assistive Technologies, Services & Operations, Institutional & Policy Management.

Any experience in existing built environments must have an integrated approach to first assess and review the presence of any such barriers and then develop strategies and ways to remove them. For all new buildings or urban environments which are in the stages of conceptualization or yet to be built must evolve a holistic accessibility structure to ensure universal accessibility and barrier free experience for all categories of diverse users.

Some of the commonly found barriers in our built environments various categories include :

### 2.6.1 Information & Communication Barriers

Barriers in information and communication include some or more of the following aspects like

- Provision of information in digital and alternative formats.
- Adequate signage and wayfinding system for any built environment in multi lingual and easy to
- Building or Spatial environment maps in visual, tactile and audio formats for wayfinding
- Visual ergonomics for readability of Text in signage
- Poor visual contrast in signage or wayfinding systems
- Digital information systems for various built environment features like transportation, etc.
- Non availability of realtime information (For eg. Bus Route or Arrival Information) Refer Image: 2.1

### 2.6.2 Built Infrastructure Barriers

1. Steps at entrances
2. Absence of adequate support and



Image 2.1 Inaccessible information design at bus shelter

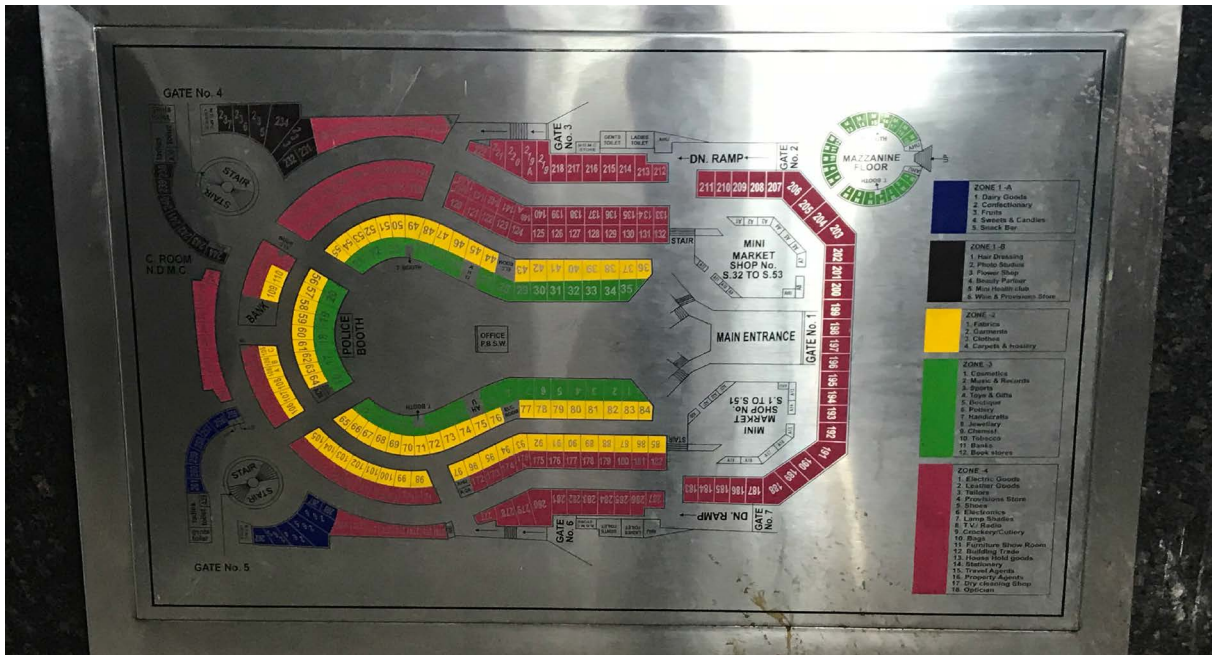


Image 2.2 Barrier: Legibility

- grab rails
3. Steep slope or slippery surfaces on ramp slopes
4. Faulty configuration or layouts of ramps
5. Steep slope ramps
6. Ramps with inappropriate configurations causing risk
7. Absence of grab rails for support movement
8. Street Crossing with high kerbs
9. Entrance Doors with no or little landing space
10. Drinking water stalls at high levels
11. Low visual contrast in steps / staircase

12. Open Air Theatre with inaccessible stage
13. Sidewalks with broken flooring
14. Unmaintained washrooms in public spaces
15. Physical barriers in between Tactile Guide paths

### 2.6.3 Services & Operations

- Provision of Capacity Building & Training to Manpower to attend to various needs of Persons with disabilities and other diverse user groups.
- Maintenance and periodic check of various accessibility features





Image 2.4 Inaccessible entrance



Image 2.3 Absence of adequate visual contrast in steps





Image 2.5 Improper parking management



Image 2.6 Inaccessible entrance with inadequate visual contrast in steps





Image 2.7 Improper ramp gradient and slippery floor finish



Image 2.8 Rumble granite strip on ramps as a barrier





Image 2.9 Curved ramp with improper detailing and design



Image 2.10 Inadequate visual contrast





Image 2.11 Inadequate colour contrast



Image 2.12 Planters as barrier and inadequate ramp slope





Image 2.13 Absence of kick plate and lever handle

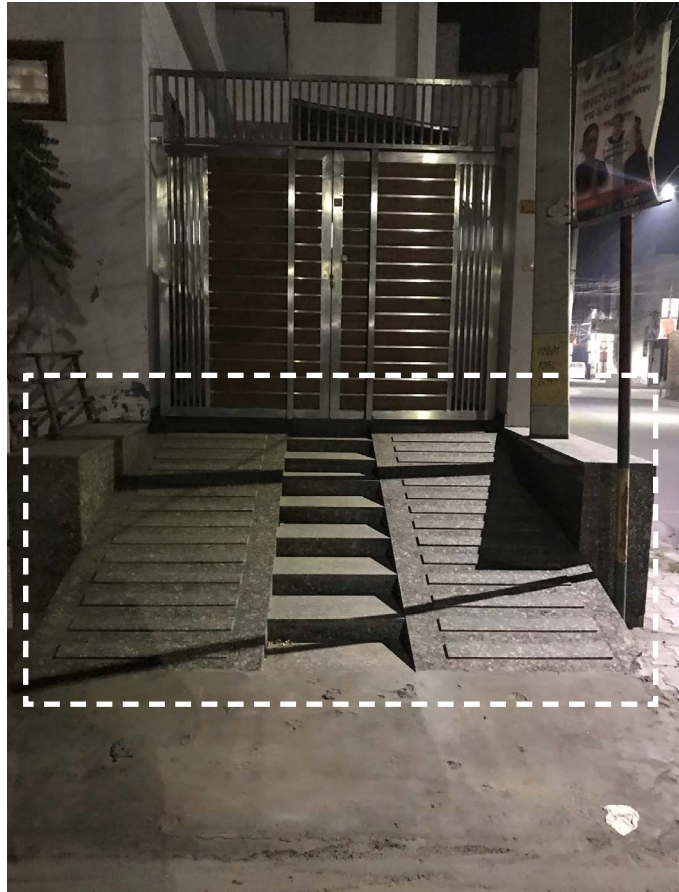


Image 2.14 Improper ramp detailing



Image 2.15 Improper edge detailing of level change





Image 2.16 Inaccessible heights for wheelchair users and children



Image 2.17 Inconsistent tactile markings and physical obstructions on sidewalks





Image 2.18 Poor visual contrast in entrance steps

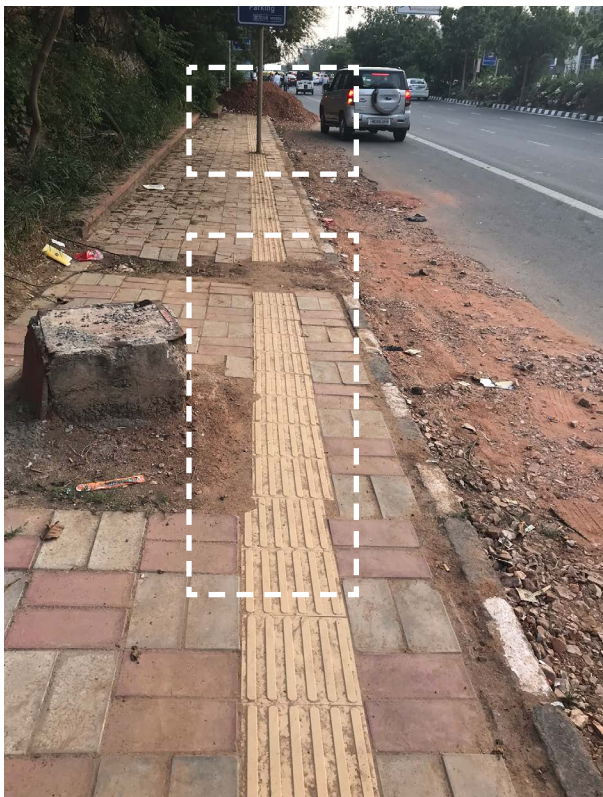


Image 2.19 Poor maintenance of sidewalks and tactile pathways



Image 2.20 Inconsistent laying of tactile guiding tiles



## Chapter 2: Understanding Accessibility



Image 2.21 Obstructions on tactile pathway



Image 2.22 Improper space and traffic management



Image 2.23 Inaccessible street infrastructure





Image 2.24 Improper ramp detailing and management



Image 2.25 Inaccessible counter heights



## Chapter 2: Understanding Accessibility



Image 2.26 Typical Barrier in built environment





Image 2.27 High kerbs and absence of kerb ramps near zebra crossing

- Regular maintenance of sanitary facilities
- Mock drills and preparedness for emergency response to situations like panic falls in accessible washrooms, attending to emergency alarms, rescue of persons with disabilities or ones with restricted mobility in case of fire or other natural disasters, etc.
- Parking and services management
- Wet and slippery floors
- Uncobbled and broken surfaces
- Broken or vandalised street furniture
- Non availability of water, litter bins, etc.
- Wear and Tear of Tactile Guide Pathways

- Unmaintained landscape with tree branches as obstructions
- Low or no illumination levels at various aspects of infrastructure like

#### 2.6.4 Policy Management

- Organisational policy and protocols for accessibility services and their provisions.
- Periodic Accessibility assessment and review policy for built environment or organisations.
- Policy for retrofitting or adaptive space transformations for accessibility.
- Policy to create Equal Opportunity Cells or Accessibility Services Offices within organisations.

## 2.7 Basic Anthropometry and Space Allowances

Anthropometric dimensions help meet the body and spatial requirements of diverse individuals. They may vary with age, gender, abilities and socio cultural distinctions of performing activities. To accommodate the needs of persons with disabilities and other diversities in an inclusive manner, it is crucial to gain sensitivity with regard to specific anthropometric requirements. For any product or element in built environments to be made accessible and inclusive, it is best to map the widest range of anthropometric possibilities and then work out the tactics of reasonable accommodation in the given context.

Some of the typical anthropometric and spatial allowance dimensions are reflected in Fig: 2.7 to 2.9 which deal with dimensions or spatial requirements for persons with walking stick or person with child in arms or wheelchair users. It also illustrates the reach of children (Table 2.2), wheelchair space requirements alongwith clear passage widths in diverse built environment contexts. It is strongly recommended to consider anthropometric requirements for diverse disabilities in the context of their assistive technologies and create room for clearances in space design. Typically, spaces for wheelchairs or baby pram maneuvering alongwith radial ranges of white canes for persons with visual impairments need to be considered with care when creating inclusive facilities in

various built environments.

Better ergonomic designs and responsive space standards facilitate human independence and efficiency in built environments while catering to the wide ranging adaptive needs of humans.

## 2.8 Accessibility Framework for Built Environments

Accessibility is a universal attribute expected from every living environment across all sectors and all scales. A city as a whole, a street as an urban design experience, a neighborhood, a home, a work place, an educational space, etc. all have to cater to an accessible experience on the whole. A framework, as shown in the table below, is proposed to achieve accessibility in built environments, in order to attain a holistic experience.

As stated in the National Building Code<sup>4</sup> 2016, the entrance, use and evacuation of buildings should be safe and easy for individuals, families and groups which include persons with disabilities. The main considerations are as follows:

1. Pedestrian access into site
2. Designated vehicular parking near the main entrance
3. Accessible path to the entrance
4. Appropriate external lighting
5. Accessible external furniture (seats,

Table 2.2 Children’s Reach Ranges<sup>2</sup>

FORWARD OR SIDE REACH	AGES 3 AND 4	AGES 5 THROUGH 8	AGES 9 THROUGH 12
HIGH (MAXIMUM)	915 mm (36 inch)	1015 mm (40 inch)	1120 mm (44 inch)
LOW (MINIMUM)	510 mm (20 inch)	455 mm (18 inch)	405 mm (16 inch)

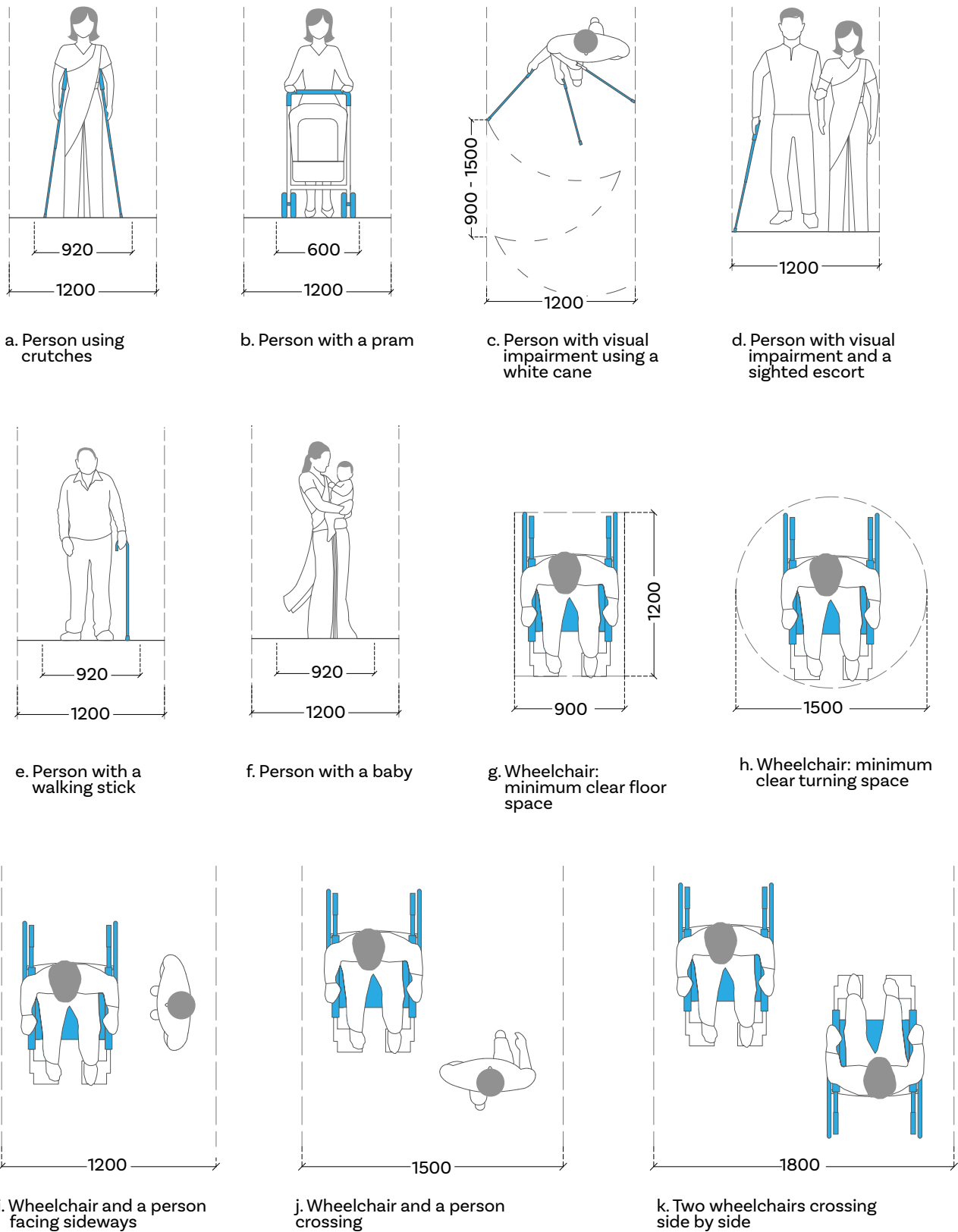


Figure 2.6 Minimum widths of a clear walkway for diverse user groups



Chapter 2: Understanding Accessibility

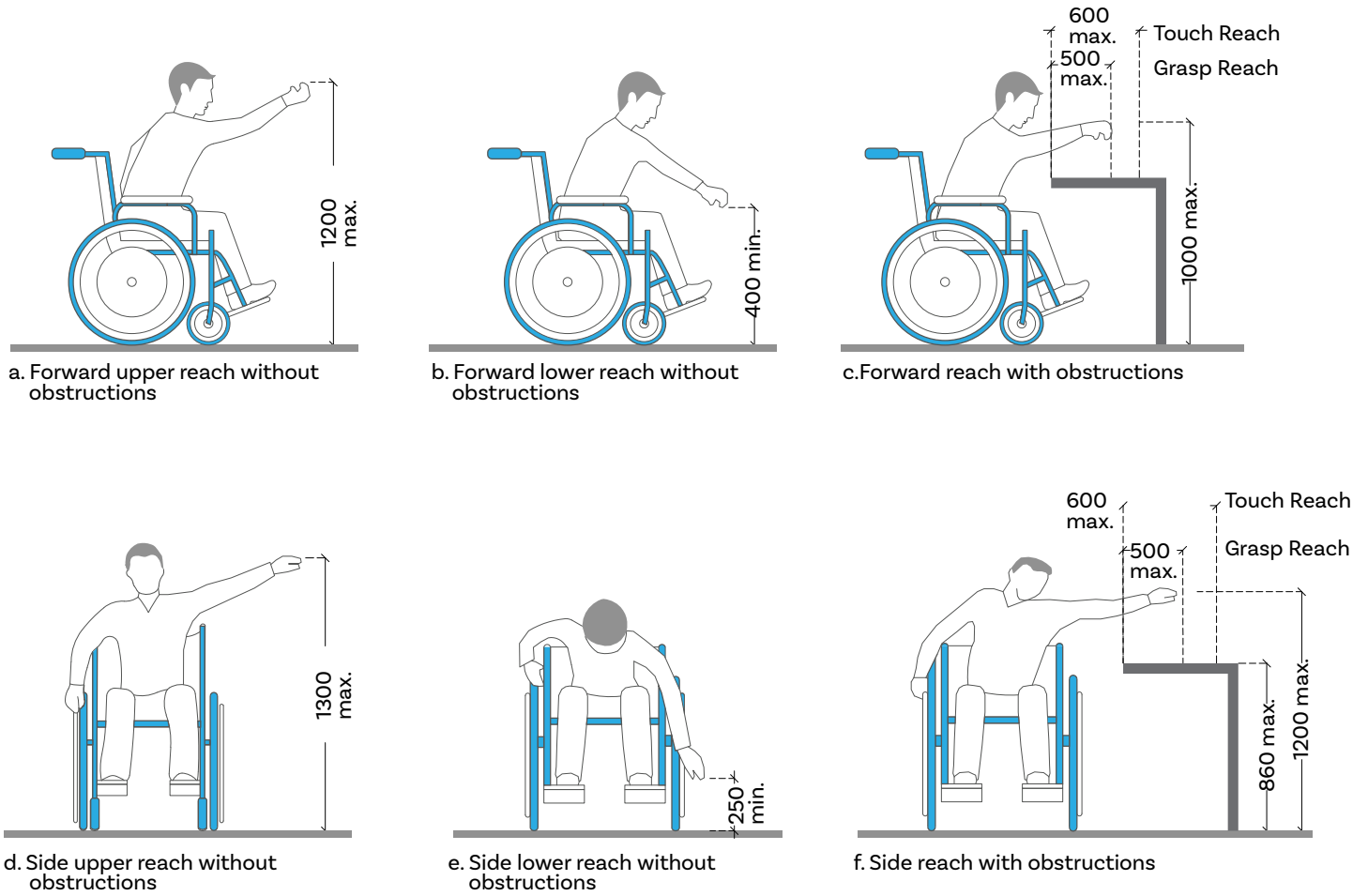


Figure 2.7 Reach ranges for wheelchair users<sup>5</sup>

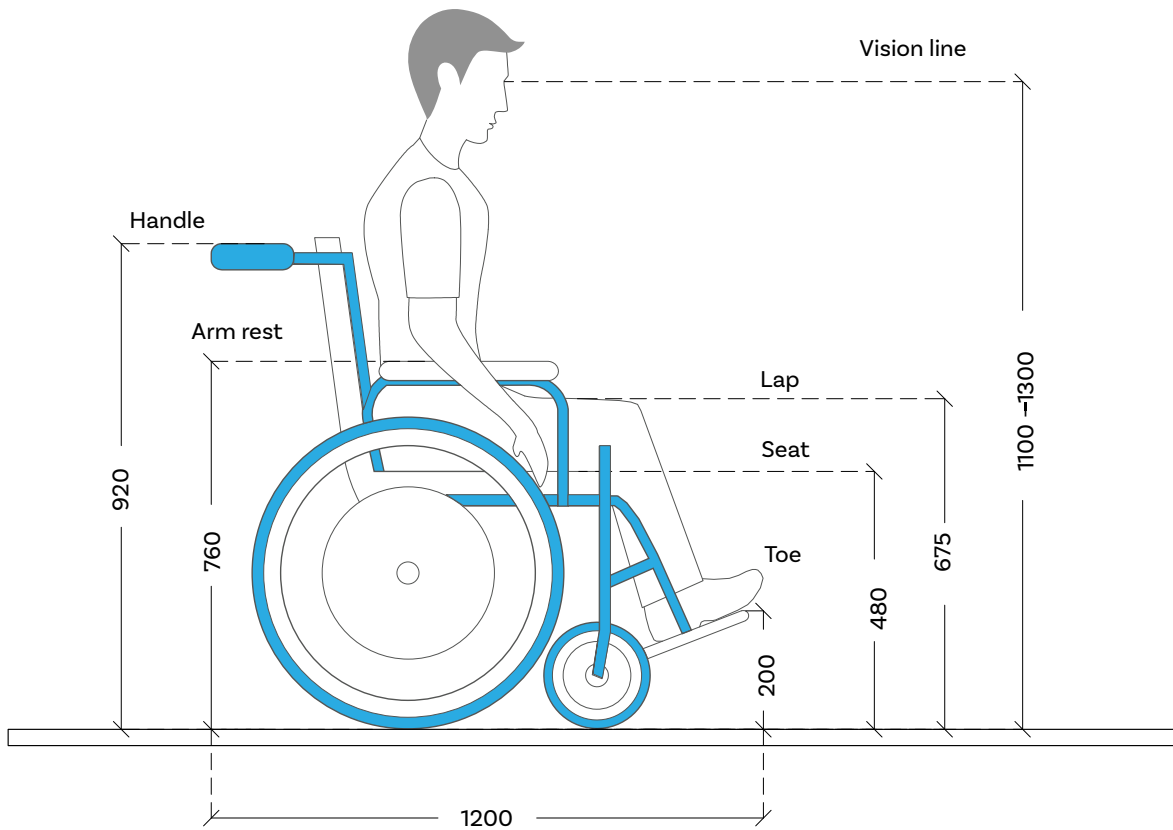


Figure 2.8 Wheelchair dimensions

- bins, etc)
6. Accessible information at the entrance to the site
  7. Suitable drop-off point near main entrance
  8. Reduced traveling distances
  9. Level entrances and exits
  10. Simple and logical layouts
  11. Unobstructed level circulation
  12. Easy access to information desks, lifts and toilet compartments for disabled persons
  13. Intuitive, obvious and accessible means of egress
  14. Spacious lifts
  15. Safe stairs that are easy to use, and facilitate safe assisted evacuation/rescue in emergencies
  16. Slip-resistant walking surfaces
  17. Wide door openings and easy door operation, sufficient space around doors that makes it possible to open and close them when seated in a wheelchair
  18. Adequate manoeuvring space
  19. Adequate height, location and easy operation of controls and switches
  20. Good lighting
  21. Good visual contrast of walls, floors, doors and signage
  22. Good signage
  23. Important information communicated via two senses or more (tactile, audible and visual)
  24. Good acoustics
  25. Hearing enhancement systems
  26. Management and maintenance of the built environment.

The above mentioned considerations may guide various stakeholders of built environments ranging from architects, planners to engineers and service providers, and help them develop accessibility in a consistent manner in various types of buildings. It would be crucial to understand that such considerations not only play a significant role at the design or planning stages but also matter in post occupancy stages of built environments to render a humane and an inclusive experience for all.

કોરોનાથી બચવા  
બસ સ્ટેશન પર  
સોશલ ડિસ્ટન્સ રાખજો

બસ, આટલું  
જરૂરી કરજો

૪ Platform Number 4

૧

સાથે રહેજો SAATH RUKHALIYO

કોરોનાથી બચવા  
બસ સ્ટેશન પર  
સોશલ ડિસ્ટન્સ રાખજો

બસ, આટલું  
જરૂરી કરજો

સુધી પહોંચીને બસ  
કેડ નીચે ઊતરવું  
પ્રિયક ડાક્ટર



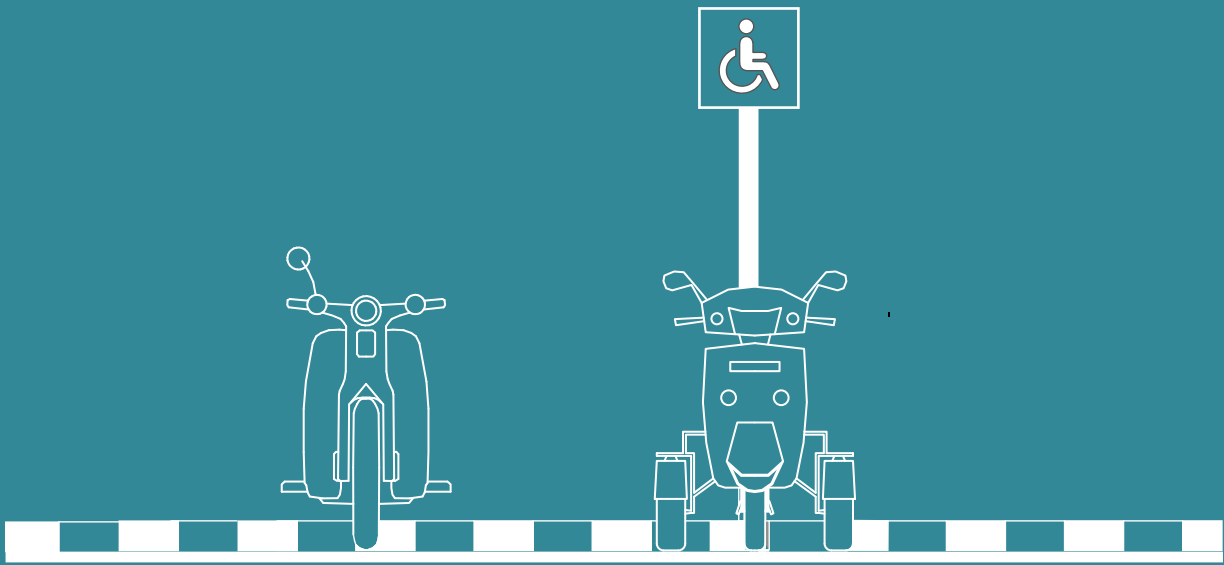


*We see a person's disability with our eyes. But our interaction tells us the person has an extra power. Then I thought, in our country, instead of using the word 'viklaang', we should use the term 'divyaang'.*

*These are people who have a limb or several limbs with divine powers which we don't have.*

**Shri Narendra Modi  
Prime Minister, India**

*Mann ki Baat, 27 Dec 2015*





# External Elements

- 3.1 Master Planning
- 3.2 Site Planning
- 3.3 Site Entrances
- 3.4 Parking
- 3.5 Access Routes and Walkways
- 3.6 Levels, Grooves and Gratings
- 3.7 Kerb Ramps
- 3.8 Pedestrian Crossings
- 3.9 Tactile Guiding Surface Indicators (TGSIs)
- 3.10 External Ramps
- 3.11 Handrails and Grab bars
- 3.12 Outdoor Drinking Water Provisions
- 3.13 External Sanitary Provisions
- 3.14 Street Furniture Elements
- 3.15 External Landscapes







***The disability is not  
the problem. The  
accessibility is the  
problem.***

***-Mohammed Jemni  
(#TED 2013)***



# 3

## External Elements

External elements in a built environment play a vital role in enhancing the accessibility of their larger ecosystem. This includes elements right from the point of entering a site of a building complex or an urban public space or any other typology. External environments make up the first integral step to provide a non discriminatory approach to inclusion of diversity by enhancing levels of accessibility across all elements. It requires a planned approach, shared coordination and periodic evaluation to truly ensure accessibility in various facets of built environment external elements. Sensitive design, features and elements of external environments shall promote inclusive societies wherein children, elderly, persons with disabilities, women, transgender and all others with or without vulnerabilities could share an equitable role in social participation and independent functioning of Activities of Daily Living (ADLs).

This chapter highlights various aspects of external environments with specific details that should be considered with regard to accessibility. Accessibility as an experience starts from the outside of a built form and must extend into all features of a building.

### 3.1 Master Planning

Accessibility as an essential attribute of built environments must be integrated at an urban scale and at a micro scale of infrastructure development. Master planning for new urban development projects, including redevelopment, revitalisation or regeneration shall ensure incorporation of universal design approach from the phase of its inception until the phase of implementation and operation. This implies master planning activity to incorporate universal accessibility features in various forms of urban futures. This includes universal accessibility in trip chain design for mobility infrastructures like multi modal interchange facilities, etc. to ensure seamless mobility for persons with disabilities in urban transportation systems, accessible neighbourhoods with adequate green and play spaces for children including play therapy for children with special needs, urban public infrastructure like accessible public washrooms for shared spaces, etc.

In an Indian context, universal access strategies must be innovated to plan for the inclusion of urban poor while enhancing approaches to include diverse abilities of physical, sensory, cognitive





Image 3.1 Accessibility in Master Planning urban infrastructure  
Photo Credits: DMRC, New Delhi









Image 3.2 Integrating accessibility through Site Planning  
Photo Credits: DMRC, New Delhi







and neuro diverse user groups. New and futuristic planning perspectives shall have to employ assistive technologies in built infrastructure to revitalise existing urban built environments.

Master planning approaches need to integrate accessibility from macro to micro scales of planning. Accessibility requires to envision implementation from first to last mile connectivity, walkability through clean well articulated legible networks/ pathways with tactile guiding systems, multi level car parks (MLCP) or pickup and drop off zones, parking, access to taxi hire points, prepaid services, provision of alternate modes of transfer, such as Non-Motorised Transportation (NMTs such as e-rickshaws, golf carts, etc.) designed for Persons with Disabilities and others, transfer zones for passengers with medical conditions with specific ambulance parking, level management through table top crossings, materials and specifications and detailing for appropriate Public Space design with landscape, lighting, external signage, urban furniture and public amenities and facilities on kerb side which are externally approachable.

Coordination amongst various stakeholders of urban built environments like transportation, civic services through municipal bodies and construction agencies like Public Works Department (PWD) etc, City level management, Information & Communication Services, etc. is required to be established at high priority in order to transform inclusive practices for procurement, tendering and construction activities.

Master planning envisions the creation of safe, human centric (child friendly, age friendly, disabled friendly, women friendly, etc.), inclusive and sustainable urban futures. This activity would also complement and be aligned with the Goal 11 of the UN Sustainable Development Goals i.e. Sustainable Cities and Communities.

### **3.2 Site Planning**

Each building and its site should be planned and designed as an integral unit from the very beginning of the design process. Site planning involves siting, locational and circulations aspects of site development for the specific built environment typology. For eg. Neighbourhood site planning shall ensure location of facilities within walkable distances or create designated pathways to reach various facilities for all.

An accessible site planning implies ease of mobility and navigation within the site, low kerb heights, adequate spaces for walkable environments, seamless connectivity, high visual contrast in elements of built environment, easily identifiable built forms and supportive infrastructure for the same including street furniture, etc.

Site planning of any campus, street or large scale urban development needs to consider the special needs of children, women, families, the elderly, in addition to ensuring accessibility for all with various disabilities.

Site planning also requires that sensitive choices are made with regard to the material for a tactile, sensory and visual experience besides physical features. Use of sensory landscapes with diverse ecological species, etc. can enhance the safety and provide wayfinding cues for people with visual impairments and also others. Public amenities in sites shall be made universally accessible to cater to a wide range of users.

Attempt should be made to minimise ambient sound/ noise levels to make sites or campuses or streets as sound proof as possible. This enhances communication possibilities for the ones with hearing and speech impairments alongwith other diverse user groups like the elderly, etc.



### 3.3 Site Entrances

Every built environment is usually approached from an external site entrance before one approaches the building entrance door. It is crucial to design for universal accessibility at every site considering various elements of a site including gate widths, security counter heights, shelter drop off spaces, clearly demarcated waiting zones, adequate illumination and connectivity with sidewalks for pedestrian routes. Needs of persons with disabilities and other diverse user groups must be considered while planning and design detailing the site entrances as shown in Fig: 3.1 and Fig: 3.2. This includes the presence of various features such as:

1. Site map with braille / tactile features along with appropriate wayfinding signage shall be part of the site entrance to aid ease of mobility for all.
2. Clear pedestrian access with inclusive features for wheeling devices such as wheelchairs, rollators, baby strollers, baggage trolleys, etc.
3. TGSIs from the point of entrance independently and safe access to the site.
4. Low height counter windows for interaction with security personnel
5. Site entrances must be designed with adequate colour contrast for legibility in context with the surrounding environment. For e.g., Mentioning Gate nos. on a site with multiple entries aids people to minimise effort and provides access.
6. Safe parking and waiting zones with adequate street furniture must be an integral part of site entrances to ensure safety for women, children, elderly, and persons with disabilities.

### 3.4 Parking

Accessible parking implies adequate parking for persons with diverse disabilities and vulnerable user groups like the elderly, etc. in built environments at all scales. Contextually, it shall include both parking for adapted scooters, tricycles, cars or any other personal vehicular system adopted by an individual with disability to reach the building premises. The following accessibility measures should be adopted for parking:

#### 3.4.1 Parking Bays

1. Reserved Parking bays for adapted scooters, tricycles or other personal mobility devices (in two wheeler category) shall have a minimum bay size of 3000 mm x 2400 mm.
2. Accessible Car Parking bay shall have a minimum size of 5000 mm x 3600 mm, which is inclusive of 1200 mm wide side transfer zone. It shall also ensure adequate space for rear transfer of persons with disabilities specially wheelchair users.
3. When two accessible bays are adjoining each other, then the 1200mm side transfer bay may be shared by the two parking bays. The transfer zones, both on the side and the rear should have yellow or white cross-hatch road markings.
4. A minimum of one accessible parking bay shall be provided in all buildings. However, built forms with higher occupancy shall follow the norm as given in table 3.1
5. The parking bay should preferably be sheltered.
6. It shall have a firm, level surface without aeration slabs or soft grounds.

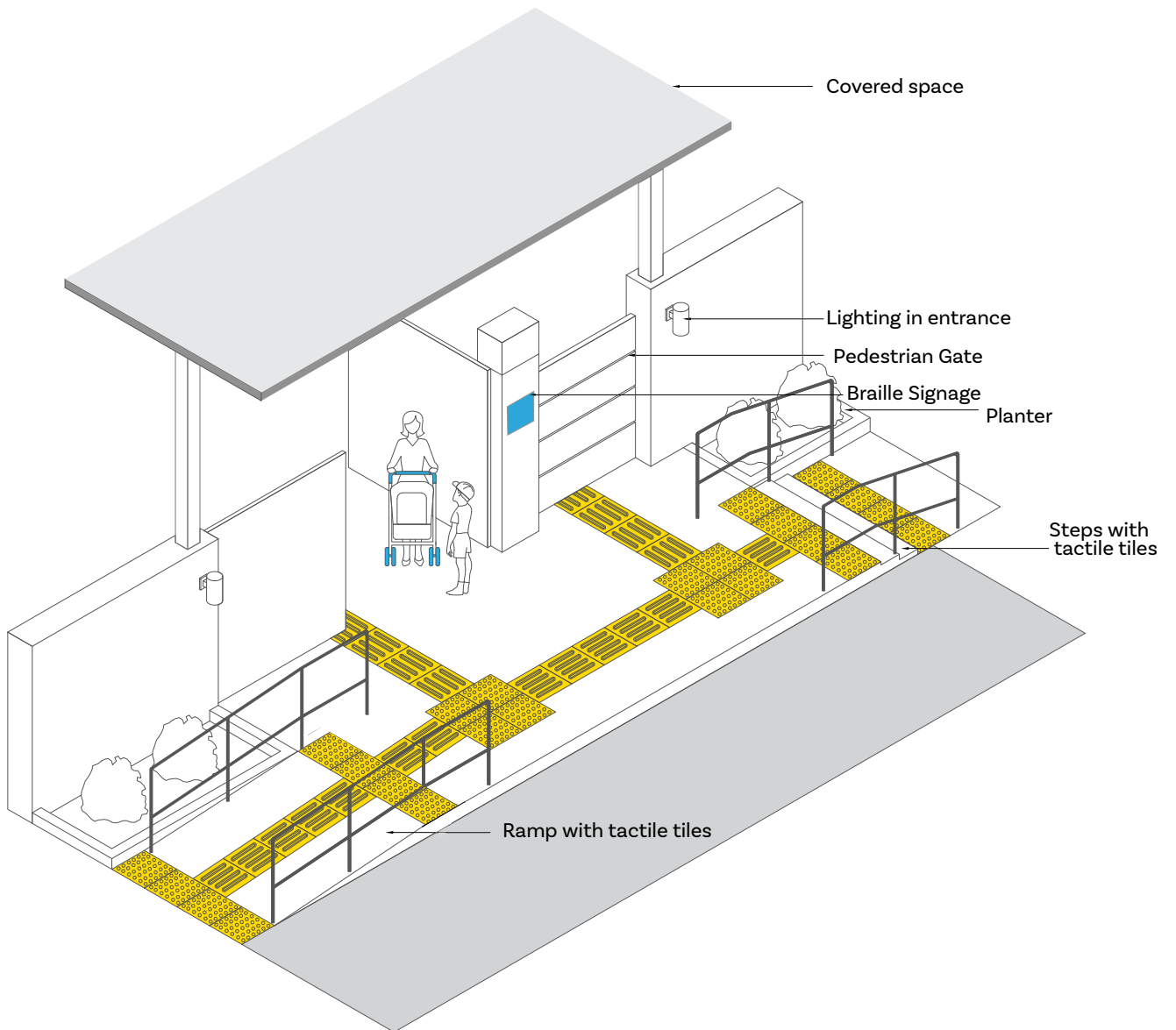
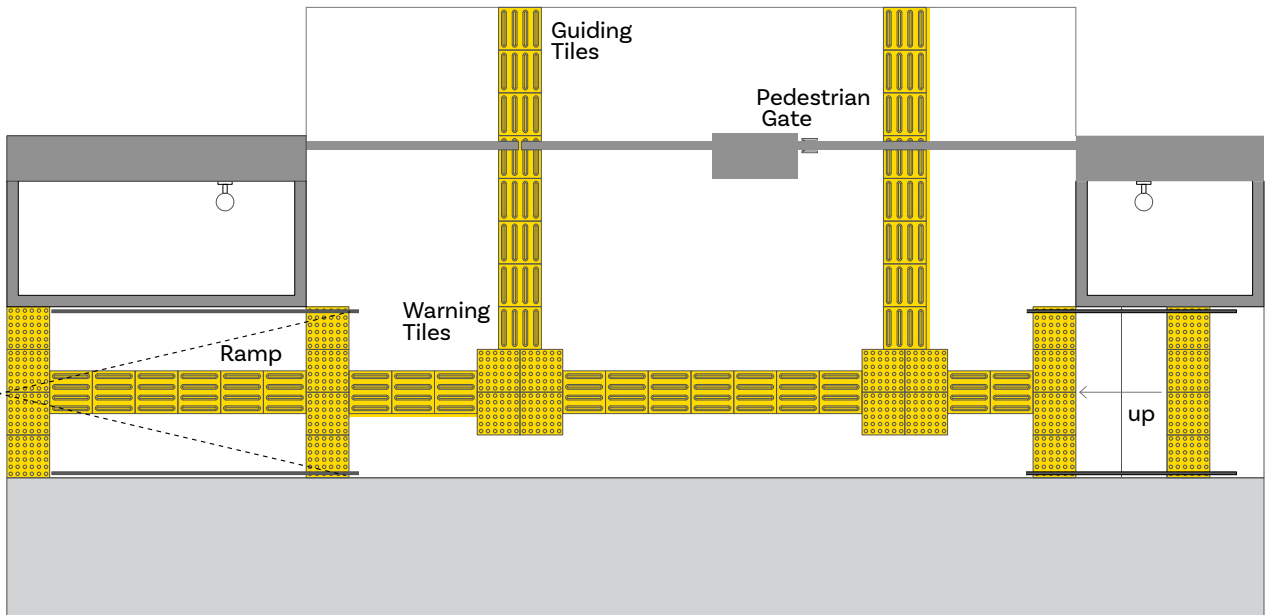


Figure 3.1 Accessible site entrances: Typical detail A

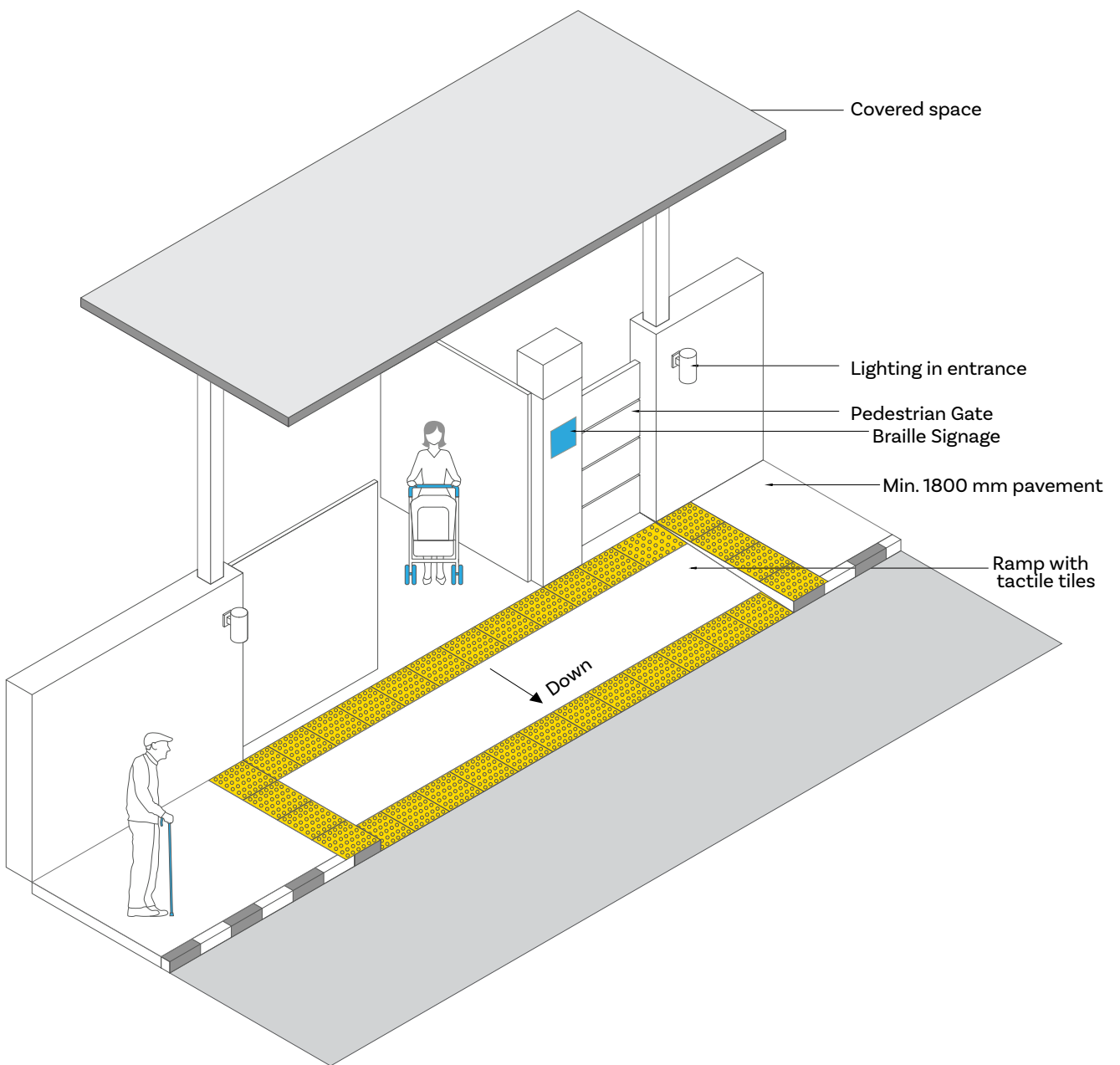
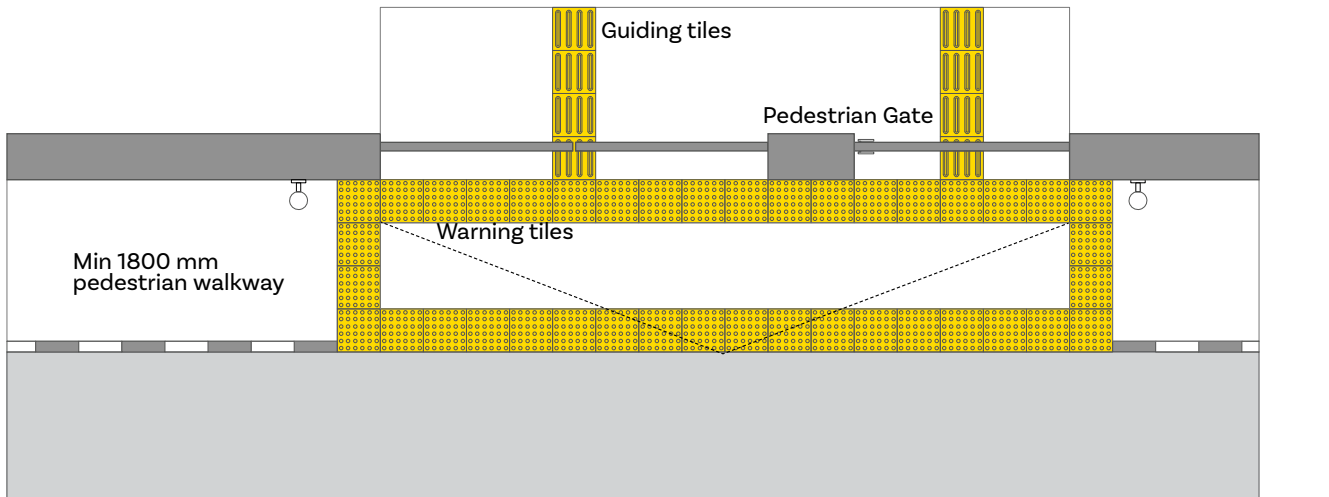


Figure 3.2 Accessible site entrances: Typical detail B





Image 3.3 Accessible reserved Vehicle parking  
Photo Credits: Dr. Gaurav Raheja



Table 3.1 Accessible Reserved Parking (Four Wheeler)

NUMBER OF VEHICLE PARKING UNITS	NUMBER OF ACCESSIBLE PARKING BAYS
For 50 parking lots (1-50)	1
Next 50 lots (51 - 100)	1
Every subsequent 100 lots or any part thereof	1

### 3.4.2 Location

- Reserved parking shall be provided within maximum distance of 30 m from the building entrances. However, efforts shall be made to preferably keep it as close as possible.
- In transport hubs such as railway stations, inter state bus terminus and airports, etc. short and long-term designated parking spaces should be provided close to the building entrance. Where there are several terminals such as in large airports, designated parking spaces should be provided close to the entrance of each terminal.
- The accessible parking bays shall be connected to the building entrance through an access route with a min. width of 1200 mm.
- Kerb ramps alongwith tactile guiding pathways shall connect the parking bays for ease in movement and to facilitate reachability to the building complex.
- Wherever the location of the accessible parking lots is not obvious or is distant from the approach viewpoints, directional signs should be placed along the route leading to the accessible parking lots.
- In underground or multi level car parks, the route from the car park to the building entrance should be accessible and easy to follow by all

car users.

- Smart Emergency Poles to be provided along pathways with two- way Audio and two-way Video Interface to control rooms ensuring safety and support to diverse user groups.

### 3.4.3 Reservation and Management

- Along with Persons with disabilities, accessible Parking provisions must integrate priority of diverse users including elderly, families with children, ones with health conditions with clearly identified signage.
- Parking management systems shall ensure keeping the reserved bays unoccupied. Except in case of medical emergency, they shall not be used by alternate users.
- Digital Parking management systems may be adopted with real time information to easily provide parking information to diverse user groups.
- It is recommended to ensure that the Parking management staff is sensitised and trained towards responding to the needs of persons with disabilities, alongwith other diverse user groups.

### 3.4.4 Signage for Parking

- Accessible parking bays shall be clearly demarcated with floor signs





Image 3.4 Accessible reserved parking bays  
Photo Credits: Dr. Gaurav Raheja



Image 3.5 Parking space requirement for adapted scooter  
Photo Credits: Dr. Gaurav Raheja



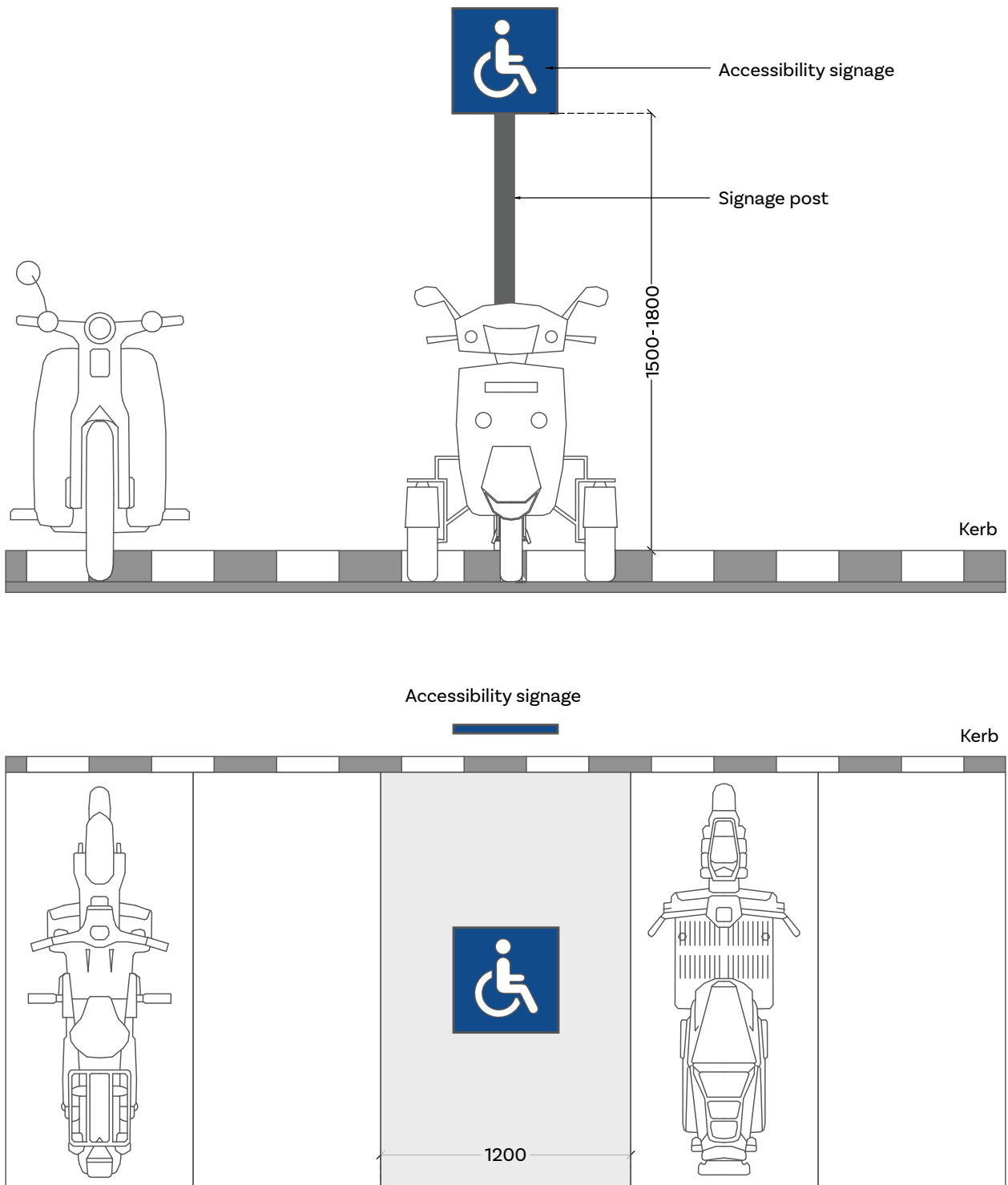


Figure 3.3 Vehicle parking (two wheeler parking/ adapted scooters)



Image 3.6 Accessible four wheeler parking bays

Photo Credits: Dr. Gaurav Raheja



G8

DL12CG7970



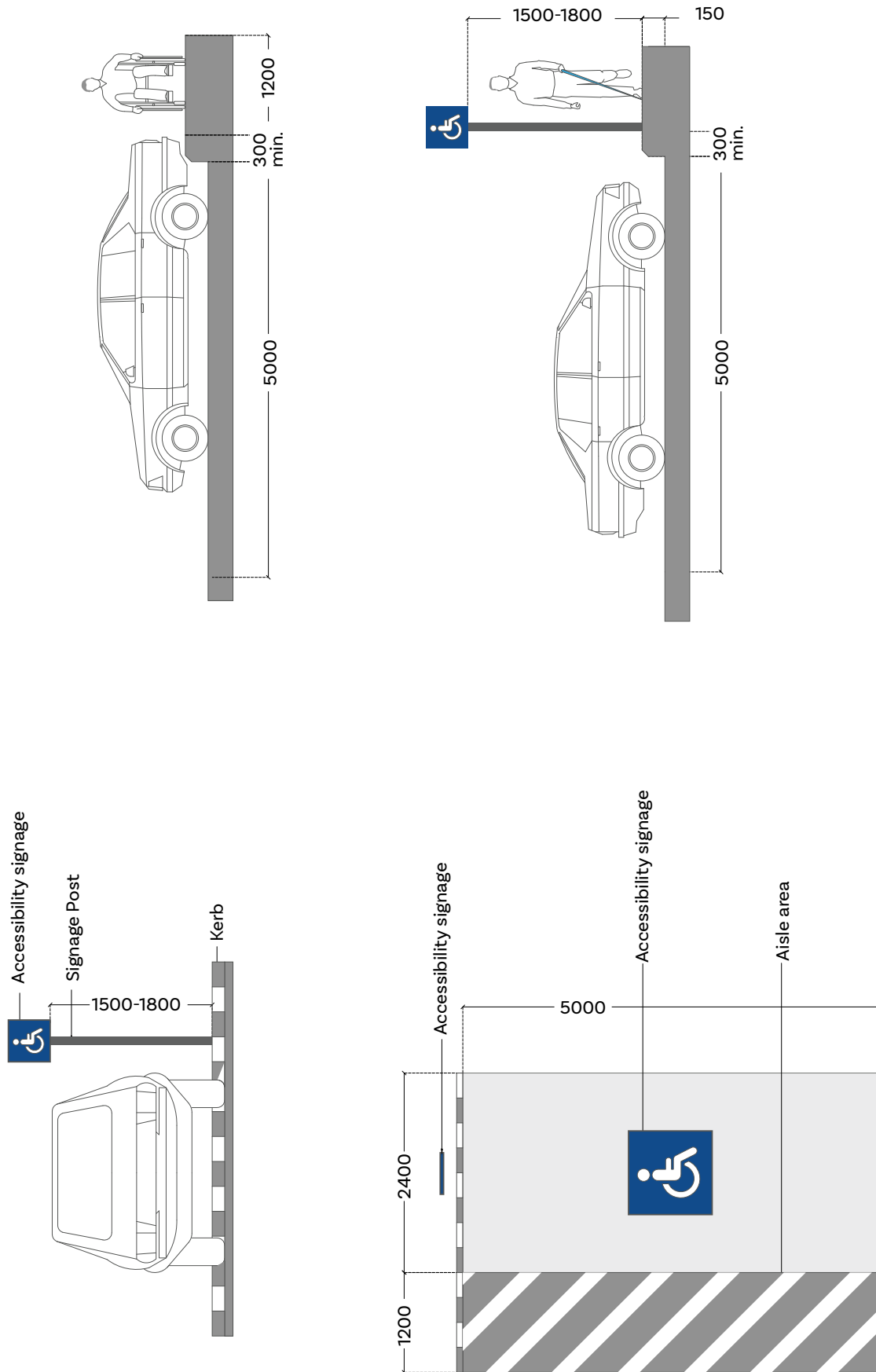


Figure 3.4 Accessible car parking bays: Plan Layout/Section

along with vertical sign posting.

2. The international symbol of accessibility (wheelchair sign) should be displayed at approaches and entrances to car parks to indicate the provision of accessible parking for Persons with Disabilities within the vicinity.
3. Directional signs shall be displayed at points where there is a change of direction to the accessible parking lot.
4. If the location of the accessible parking lot is not obvious or is distant from the approach viewpoints, the directional signs shall be placed along the route leading to the accessible parking lot.
5. Accessible parking lots should be identifiable by the International Symbol of Accessibility. The signs

should not be obscured by a vehicle parked in the designated lot.

6. Vertical signs at a visible height range between 1500 to 1800 mm shall be provided, to make it easily visible.
7. As a best practice, telephone numbers of building management or relevant authority shall be clearly printed on them for the purpose of reporting unauthorised parking.
8. Parking bay numbers shall be provided with legible colour coding to enhance visual accessibility for all in the car parking.

### 3.4.5 Symbol

International Symbol of Accessibility should be clearly marked on the accessible parking lot for drivers/riders with disabilities only. The symbol painted

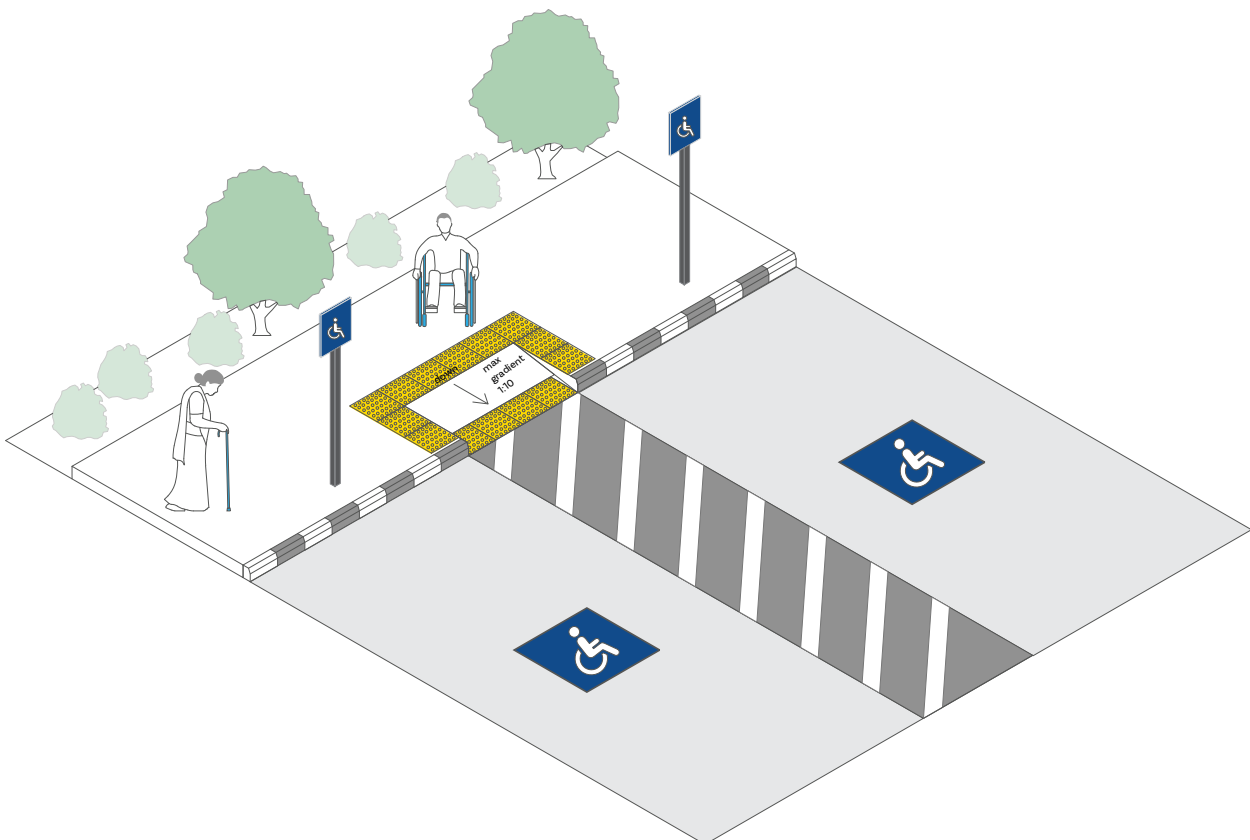


Figure 3.5 Accessible car parking bays: 3d Visualization

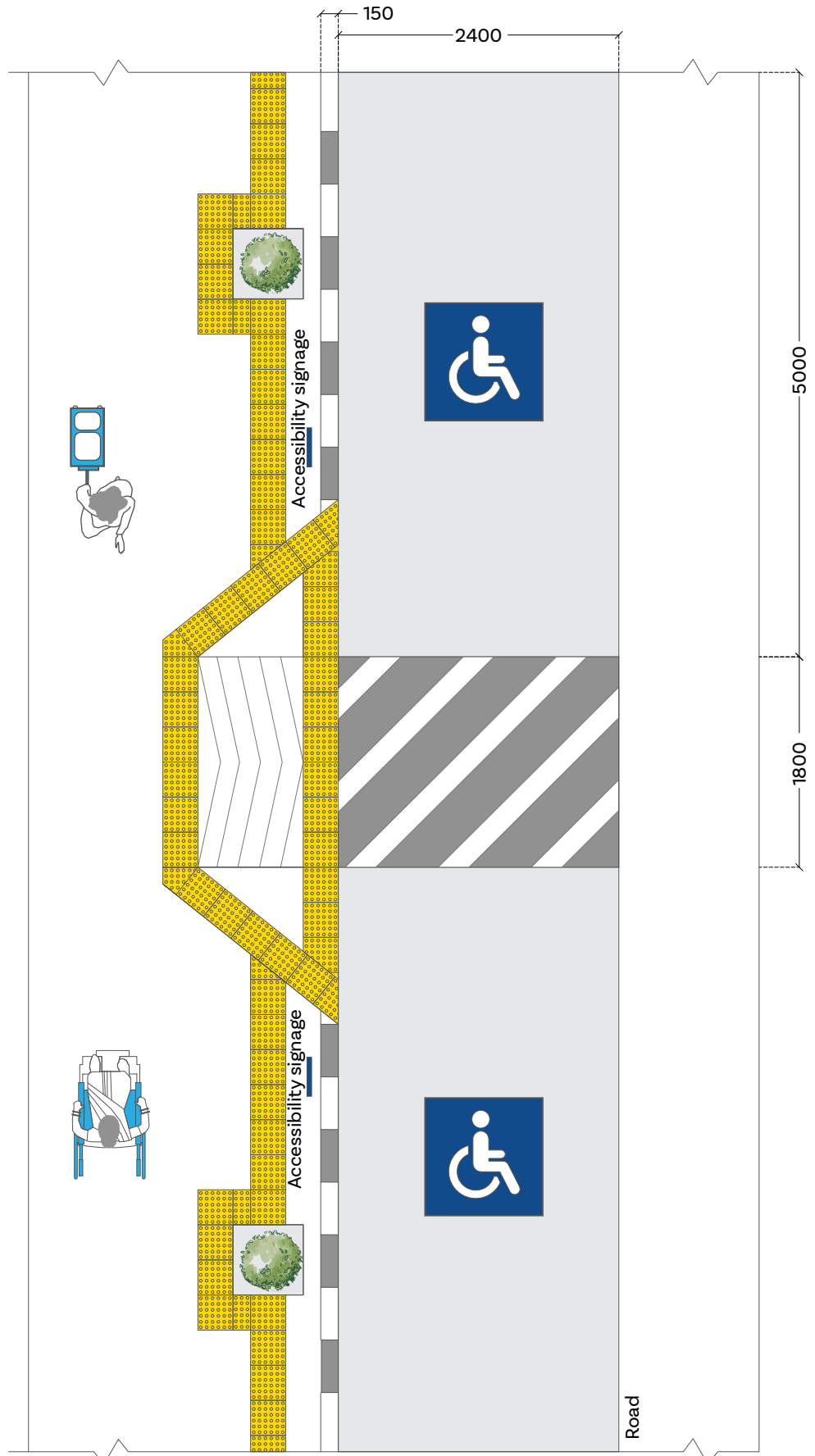


Figure 3.6 Typical accessible car parking unit: Type A



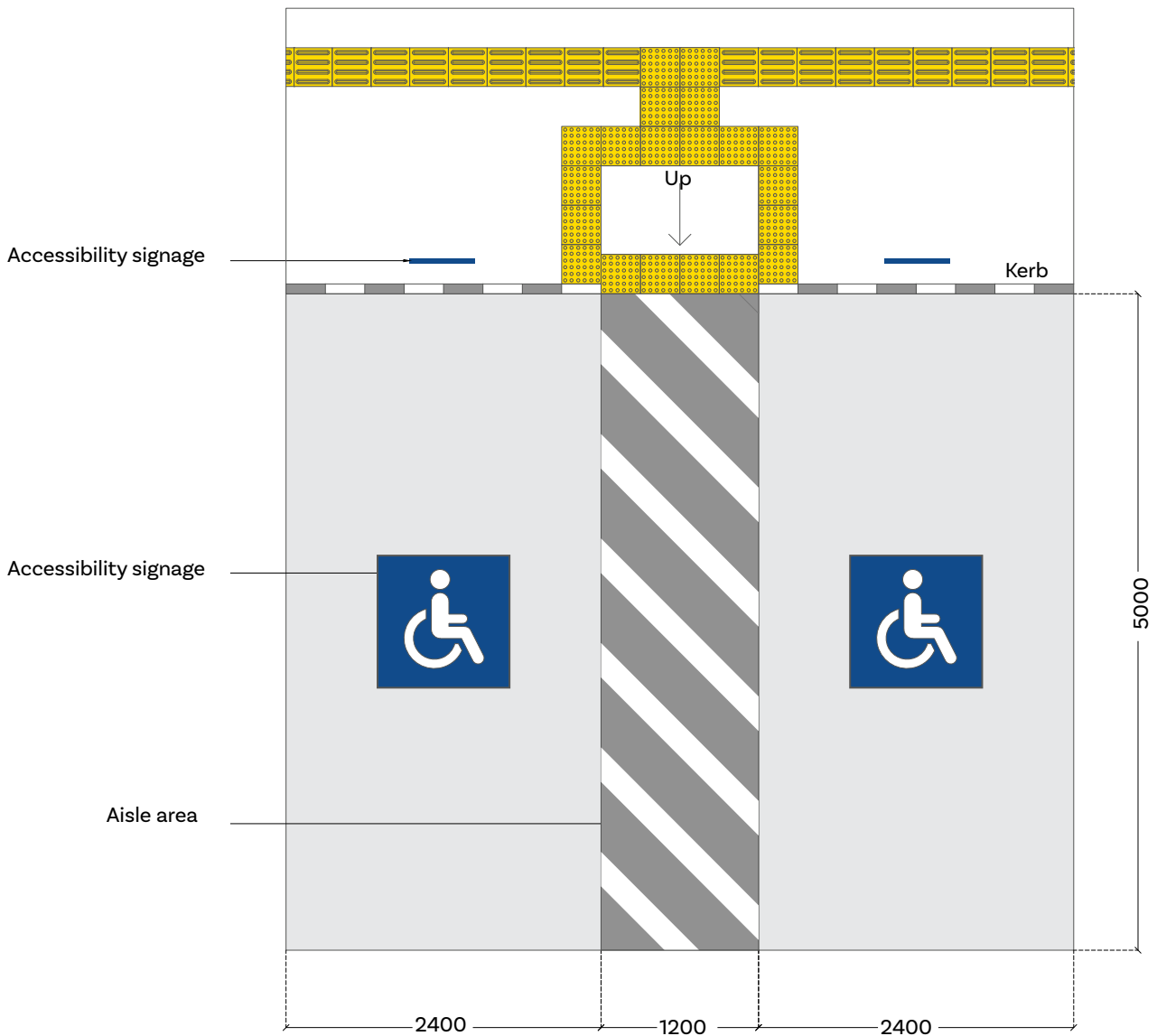


Figure 3.7 Typical accessible car parking unit: Type B

on the designated lot should consistently adhere to the norms as given below:

1. A square with dimensions of at least 1000 mm but not exceeding 1500 mm in length;
2. Be located at the centre of the lot; and
3. The colour of the symbol should be white on a blue background. For ease in standardisation the blue may be referred as UN Blue.

### 3.5 Access Routes / Walkways

Access routes and walkways define the mobility character of a site or of the built environment. In simple terms, walking routes or pathways are one of the critical elements to make sites socially inclusive allowing diverse user groups to access them. To make them universally accessible, the following recommendations shall require to be adhered to.



Image 3.7 Access Routes in outdoor landscapes  
Photo Credits: Dr. Gaurav Raheja



Image 3.8 Access Routes in outdoor landscapes  
Photo Credits: Dr. Gaurav Raheja





Image 3.9 Pedestrian pathways  
Photo Credits: Dr. Gaurav Raheja



Image 3.10 Access Ramps with steps  
Photo Credits: Dr. Gaurav Raheja



### 3.5.1 Widths and Heights

1. Minimum walkway widths shall be 1200 mm. However, for two way traffic they should be 1800mm wide. In exceptional cases (such as around trees/poles etc.); the recommended clear width could be 1500mm.
2. The walkway should not have a gradient exceeding 1:20. It also refers to cross slope.
3. For walkways greater than 60 m in length, resting spaces with street furniture shall be provided at every 30m length of it. Seating height should be between 450 mm-500 mm, have a backrest and hand rests at 700 mm height.
4. Covered walkways shall have a minimum clear height of 2200 mm.
5. Grab rails on both sides shall be provided along access routes or walking trails wherever the land terrain is sloping or undulating. The grab rails in contrasting colours shall be fixed at two levels ranging between 700 to 900 mm.

### 3.5.2 Walkway Details

1. Walkways should be smooth, hard and have a levelled surface suitable for walking and wheeling. Irregular surfaces such as cobble stones coarsely exposed aggregate concrete, bricks etc. often cause bumpy rides and should be avoided. They shall enable wheelchair users, parents with baby prams, elderly using rollators or individuals using baggage trolleys to wheel with ease.
2. Wherever grass pavers are used as materials for access routes, it may be ensured to keep a walkway of minimum 1200 mm as flat surface for mobility of diverse user groups. For

eg. Persons with ambulant disabilities like cane or crutch users, persons wearing high heels, persons carrying heavy baggage trolleys, etc.

3. The walkway shall be constructed with a non-slip material and the surface should be different from the rest of the area to avoid any slippage or falls.
4. Level changes if any, within the walkway shall be highlighted with contrasting colours or distinct material change.
5. Continuous TGSIs shall be laid on the access routes to make them universally accessible to persons with visual impairments as well. TGSIs shall be avoided to be placed on the edge of an access route with a minimum distance of 300 mm from any level change or any obstruction.
6. TGSIs with warning blocks at 300mm before and after finishing the walkway should be provided.
7. Texture change should be provided through alternative materials for persons with visual impairments in walkways adjacent to the seating by means of tactile warning tiles.
8. Walkways shall be free from any protruding objects like vegetation, furniture and sign boards.
9. As far as possible, gratings and manholes should be avoided in the middle of access routes. If they are unavoidable, then it must be ensured that they are well maintained, kept at level surface and demarcated by a colour contrast for ease in mobility for persons with low vision and others.
10. During maintenance activity, alternate access routes of temporary nature be created with similar widths and specifications.



Image 3.11 Accessible Pedestrian Pathway  
Photo Credits: Dr. Gaurav Raheja



### 3.5.3 Lighting, Illumination and Signage

1. Walkways should be well illuminated ensuring adequate visual contrast and unobstructed routes for all. Lighting fixtures not exceeding a height of 4m from ground level should be provided. This would enhance accessibility for persons with low vision.
2. If lighting intensity of the lighting fixture is increased the height of mounting the fixture from the ground level may also be increased, for providing optimum illumination level
3. Light pole may preferably be located within the tree-planting zone.
4. Lower level light poles are preferred to avoid shadow where there are high trees.
5. Universally accessible signage using pictograms for various public amenities in the built environment shall be provided along access routes for ease in navigation.
6. For access routes longer than 60 m, direction signs with distances shall also be provided to enable first time visitors or persons with diverse abilities to plan and orient their mobility better.

### 3.6 Levels, Grooves and Gratings

Level changes in built environments, grooves in construction systems and

gratings as drain covers, etc. form an integral part of infrastructure systems. The role of such elements is crucial for functional purposes, such as segregating functional areas, covering undulating terrains, accommodating material changes, responding to drainage or other underground services, etc. It is however expected that they should not become access barriers to persons with special needs, wheeling devices or with diverse abilities.

#### 3.6.1 Levels

1. Vertical level changes upto 6 mm may not need edge treatment to pass over them using wheeling devices like wheelchairs, baby prams, etc.
2. Level changes between 6 mm and 15 mm should be levelled off with a slope no greater than 1:2. Other details for level changes and gradient shall be as per Table 3.2 given below.
3. People with low vision, the elderly, expectant mothers or walking individuals on their mobile phone, may trip over level changes if not legibly contrasted and well illuminated.
4. Level changes shall have to be marked with a contrasting colour strip, preferably through a contrasting flooring material itself. However, as a retrofitting measure contrasting colour strips may be installed over the edges.

Table 3.2 Changes in levels <sup>2</sup>

CHANGES IN VERTICAL RISE (MM)	GRADIENT NOT STEEPER THAN
0 to 15	1:2
more than 15 to 50	1:5
more than 50 to 200	1:10
Exceeding 200	1:12



### 3.6.2 Grooves

1. Grooves in flooring either as expansion or construction joints or for other purposes of retrofitting need to be well covered to ensure that either they are well covered to ensure smooth access for all.
2. If not well identified, they may cause people to trip over. It is therefore recommended to provide adequate visual contrast for the same.
3. In case the grooves are temporary and cannot be covered for the entire length, an access path should be created to manage the same.

### 3.6.3 Gratings

1. Gaps in gratings and walking surfaces should not be more than 12mm in width (Refer Fig: 3.9 & 3.10 ) and be placed such that their length is perpendicular to the dominant direction of travel. This will help

prevent wheels (of wheelchairs, baby prams, baggage trolleys, etc.), walking sticks and heels from getting caught in the gaps.

2. Alternately, perforated gratings in stone or steel finish could be installed.
3. Manholes, gratings and drains should preferably be located to the side of the walkway and levelled with the ground surface. They should not be located at the centre of the path as they may become tripping hazards.
4. Grating should be flush with finished ground or floor level.
5. Drain covers should be made of materials that are non-slip in both wet and dry conditions. Metal chequered plates, which tend to be slippery when wet, should be avoided.
6. Where possible, gratings should be located outside the minimum clear width of the outdoor recreation access route.



Image 3.12 Accessible grating details ( Perforated grating type)  
Photo Credits: Dr. Gaurav Raheja

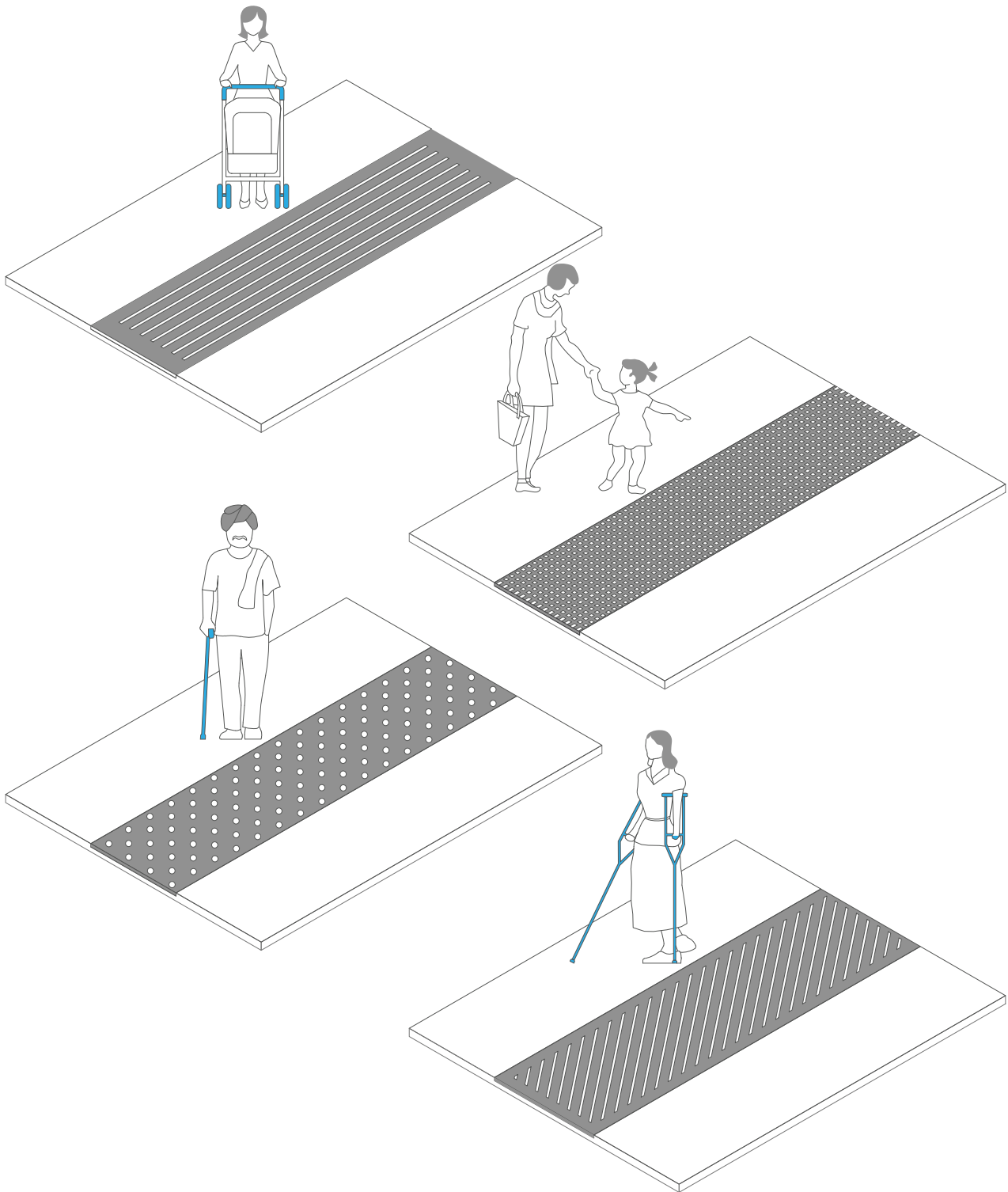


Figure 3.8 Accessible street grating typologies

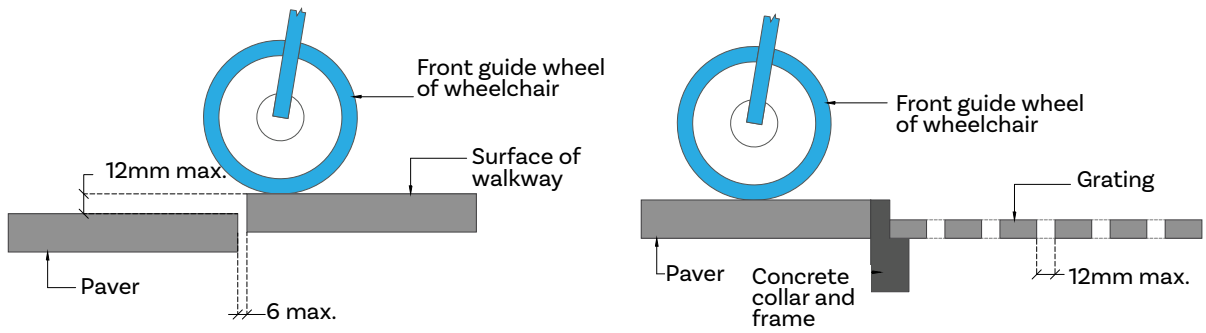


Figure 3.9 Accessible street grating details: Sectional elevation

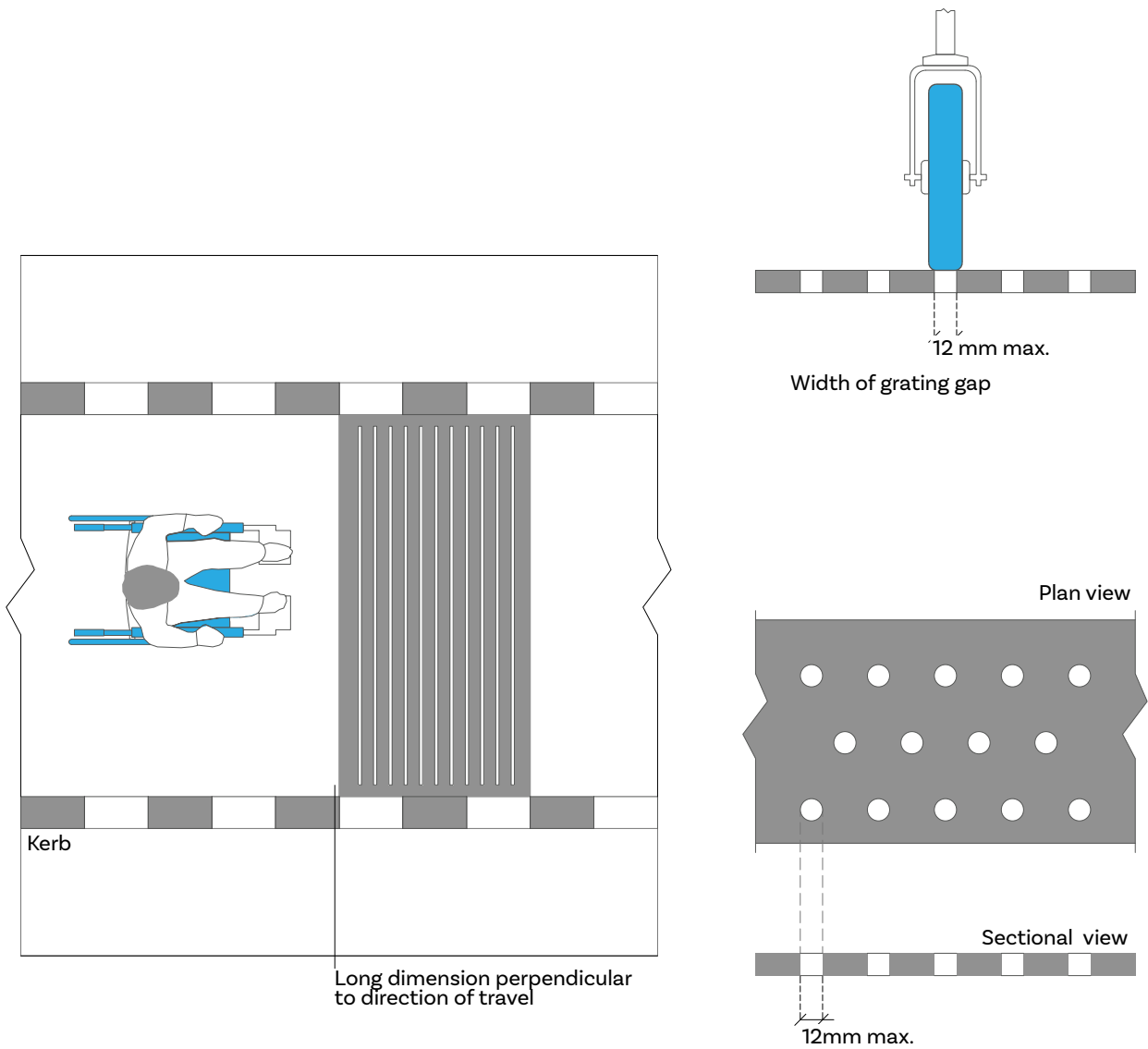


Figure 3.10 Accessible street grating details: Plans layout



### 3.7 Kerb Ramps

Kerb ramps shall be provided to make pathways, access routes and sidewalks accessible for all, enabling convenience for persons with reduced mobility, wheelchair users, parents with baby prams, elderly etc. Kerb ramps may be placed and designed with the following guidelines.

#### 3.7.1 General Characteristics

##### Kerb ramps

1. can typically be of four types viz.
  - a. With flared sides
  - b. With returned or continuous kerbs
  - c. With built up or extended kerbs and
  - d. With parallel kerbs.
2. Are provided preferably for kerb heights upto 200 mm. Kerbs higher than 200 mm may pose challenges to safe slopes for persons using wheelchairs, etc.
3. The surface finish should be slip resistant
4. Should be designed not to allow water accumulate on the walking surface;
5. Do not require handrails
6. Should not project into the road surface as they may pose a danger to users and an obstruction to vehicles
7. Edge surfaces have to be completely level with the road.
8. Should be located or protected to prevent obstruction by parked vehicles;
9. Should be free from any obstruction such as signposts, traffic lights, etc.

10. When located at road crossings or other identified paths intended for pedestrian use while crossing a vehicular way, they should have a detectable warning surface in the form of tactile warning indicators at both entry and exit points connecting the tactile guiding path on the walkway.
11. Have a detectable warning surface of 600 mm depth where the colour and texture are contrasted with the adjacent surfaces.

#### 3.7.2 Gradient

The gradient of a kerb ramp should not be steeper than 1:12; the flared sides should not be more than 1:10.

#### 3.7.3 Width

1. The width of kerb ramps is recommended to be equal to the width of the pedestrian walkway and should not be less than 900mm.
2. Wherever walkways are narrow, parallel kerbs are preferred.

#### 3.7.4 Flared Sides

1. Kerb ramps should have flared sides where pedestrians are likely to walk across them
2. The gradient of the flared side should not be steeper than 1:10

### 3.8 Pedestrian Crossings

Pedestrian crossings or street intersections play an important role in determining the walkability in street environments. Safe and accessible crossings or intersections enhance



Image 3.13 Accessible flared kerb ramp at pedestrian crossing  
Photo Credits: Dr. Gaurav Raheja

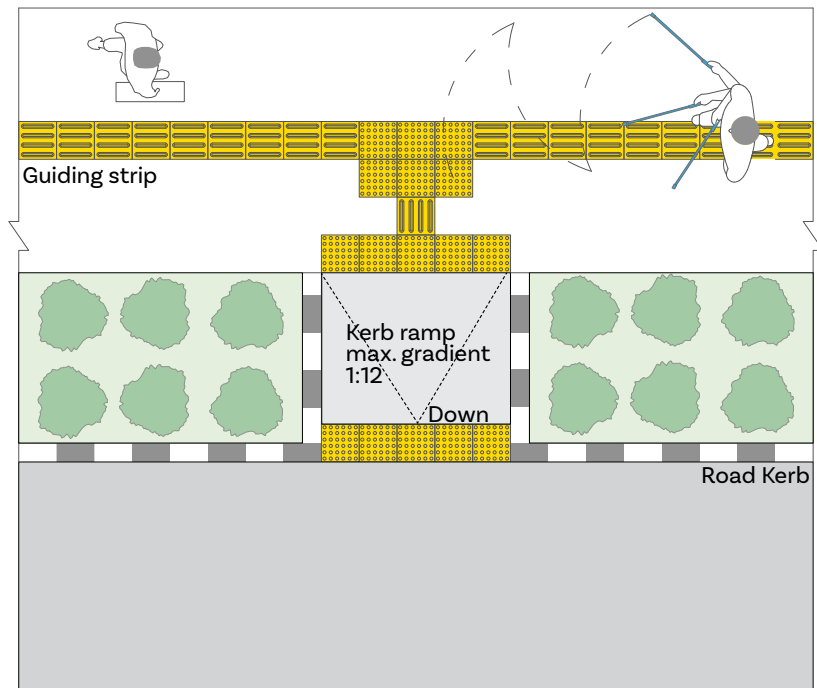
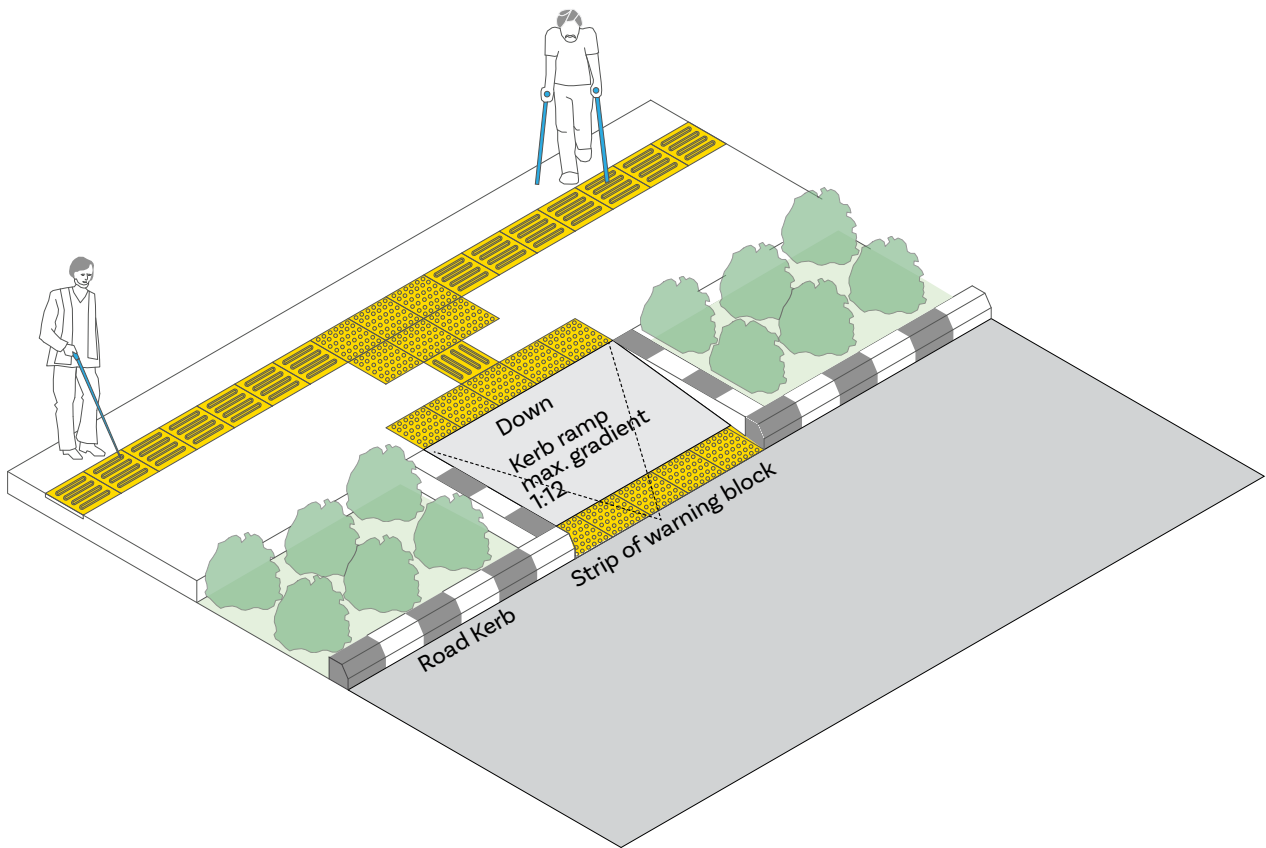


Figure 3.11 Accessible kerb ramp: Typical detail A



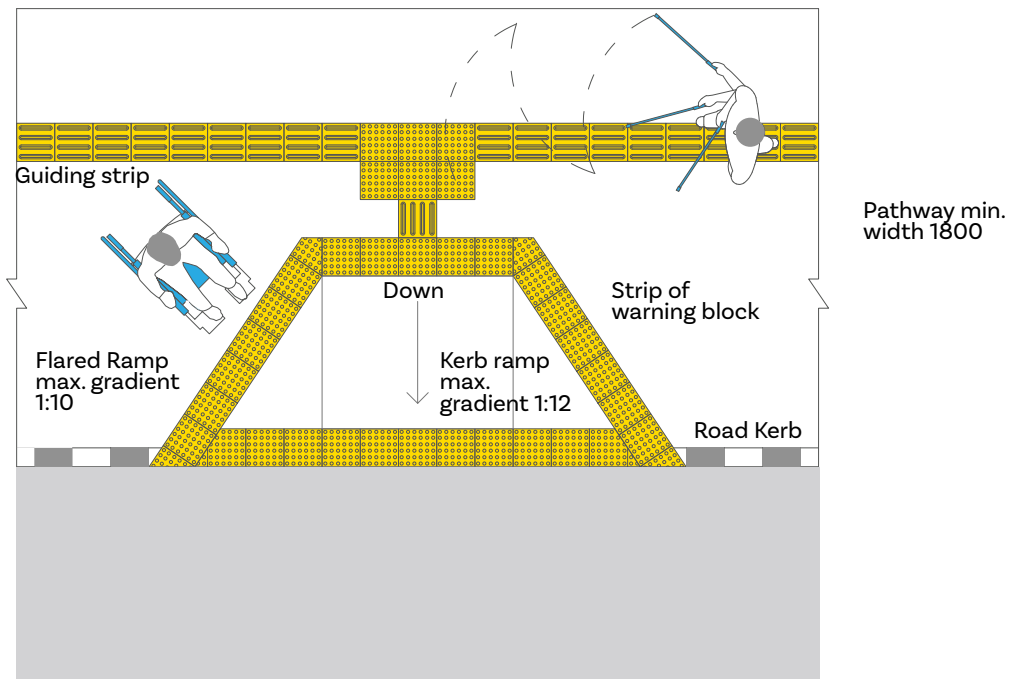
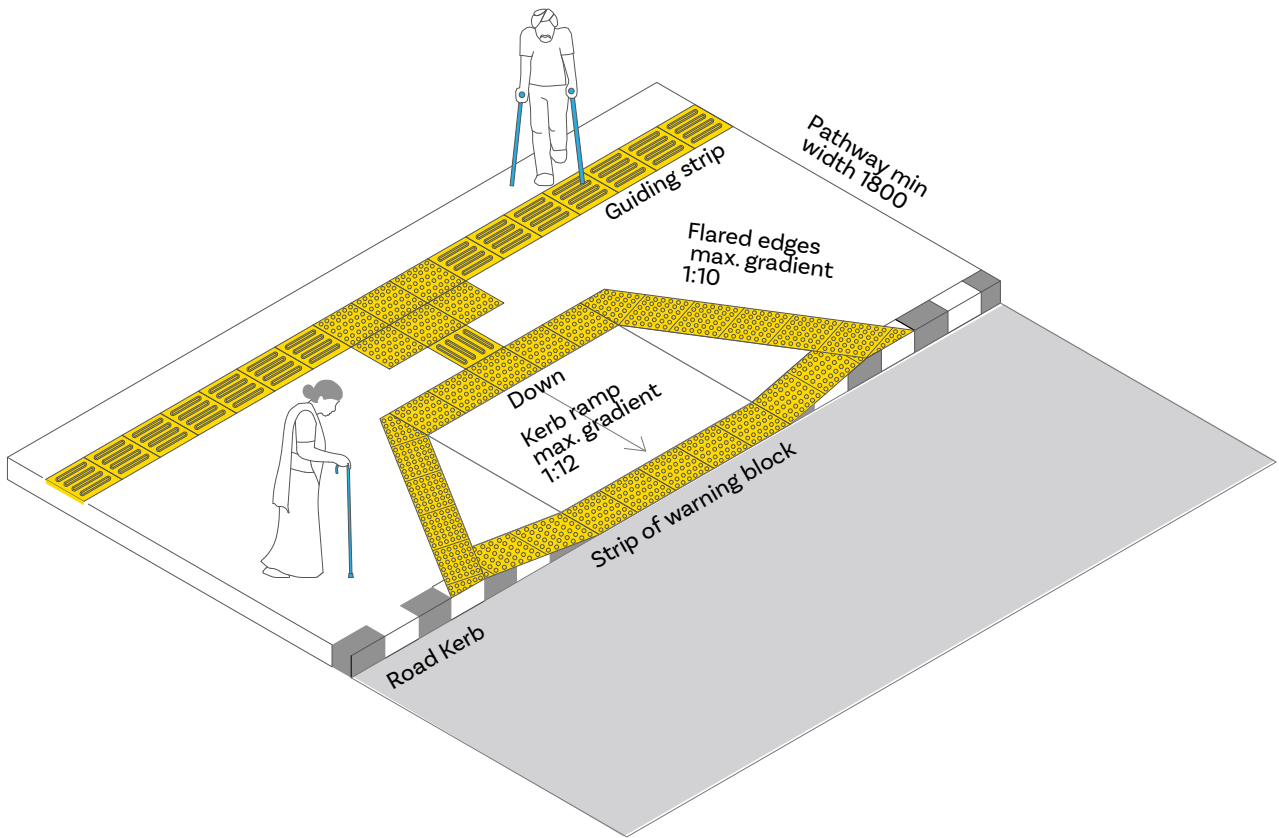


Figure 3.12 Accessible kerb ramp: Typical detail B



Image 3.14 Accessible road intersection with pedestrian crossing  
Photo Credits: Dr. Gaurav Raheja

mobility for all, including wheelchair users, baby prams or people with luggage trolleys. It also remains a vital element in trip chain connectivity for a seamless pedestrian experience.

### 3.8.1 General Characteristics

1. All intersections between pedestrian paths and roadways must be accessible in order to allow passage to all users, regardless of their functional limitations.
2. The pavement colour and texture of the surface that connects the accessible path to the crossing shall be identical to the pedestrian path.

3. If there are traffic lights or signals at the pedestrian crossings, they should meet the specifications of section 3.8.5.
4. At pedestrian crossings, tactile floor guidance should be provided in compliance with guidelines in Section 3.9

### 3.8.2 Intersections with raised pedestrian crossing

The sidewalk shall maintain a continuous surface without lowering to the roadway level during the crossing. Pedestrians should not experience any changes in ground level during the crossing of the intersection (refer Image: 3.13 & 3.14).



This intersection is considered accessible when it fulfils the following requirements:

1. The total width of the continuous raised surface above the roadway is:
  - At least 7000 mm when there are bus lanes or coaches or their passage is expected in the roadway.
  - The same crosswalk width or at least 2000 mm from the roadway ramp, without being interrupted by any obstacle or any pavement rising.
2. The surface height shall be between 100 mm and 150 mm above the road, and the longitudinal gradient of the roadway ramp cannot exceed more than 15%.
3. The crosswalk is marked on the raised surface for all its width.

4. The sidewalk edge of the pedestrian crossing should be marked with a strip of tactile warning surface. This tactile warning surface should run across the width of the pedestrian path and should fulfil the requirements established in section 3.8.
5. Roadway water evacuation solutions should be resolved without causing a level change, a step or a gap across the crosswalk.

### 3.8.3 Crossing at Road Level

1. Kerb ramps at pedestrian crossings must be wholly contained within the area designated for pedestrians' use.



Image 3.15 Pedestrian crossing with pelican signals  
Photo Credits: Dr. Gaurav Raheja



2. Detectable warning surfaces in the form of tactile surface ground indicators
3. Used at pedestrian crossings and kerb ramps must be in accordance with guidelines for TGSIs as stated in Section 3.8.

### 3.8.4 Intermediate Islands

A pedestrian speed of 0.6 m/s should be used to assess the crossing speed of pedestrians. If the time to cross the crosswalk is not enough due to the street's length, an intermediate island should be provided.

The intermediate islands should fulfill the

following requirements:

1. The length of the island shall be at least 1500 mm.
2. The island pavement should be the same colour as the pedestrian path.
3. Both island edges should be marked with detectable warning pavement at least 300 mm wide and the same width as the pedestrian crossing.

When two traffic directions are separated by an intermediate island and have different green cycles, pedestrians should be required to wait in the central island for the green light and guardrails shall be placed to guarantee that pedestrians stop in the island.



Image 3.16 Accessible Pedestrian crossing  
Photo Credits: Dr. Gaurav Raheja

The offset intermediate islands should fulfil the following requirements:

1. The entrance and exit of the pedestrian crossing at the intermediate island shall be misaligned.
2. The path between the entrance and the exit shall be protected on both sides with guardrails, dwarf walls or other protection elements.
3. The island pavement should be the same colour as the pedestrian path. Both island's edges should be marked with detectable warning pavement of at least 300 mm wide and the same width as the pedestrian path.

### 3.8.5 Accessible Pedestrian Signals

In addition to the visual traffic signals (refer Image: 3.15), accessible pedestrian signals on the accessible pedestrian crossing shall have three types of sound signals that fulfil the following requirements:

1. Activation acoustic signals: it is activated by user demand by touching the area around the traffic light button or by a mobile application that links the user's phone with the traffic light. It identifies the exact location of the transmitter signal and the location of the pedestrian crossing. This signal informs the user of the activation of the pedestrian crossing signal in the next passage cycle. It should be of short duration, with eight tones in two rounds.
2. Pedestrian crossing signals: automatically emitted during the pedestrian crossing cycle and maintained throughout the cycle. It has a distinctive tone, slow and intermittent.
3. Pedestrian signals for final crossing: it

matches the final flashing green light cycle and informs of the imminent finishing crossing time. It has a distinctive tone, fast and intermittent.

4. The time interval of the crossing should be programmed keeping in account the needs for persons with reduced mobilities or slowest movement. The sound shall be set to ensure the crossing time of the traffic light cycle, taking into account a maximum pedestrians' speed of 0.6 m/s. If this requirement cannot be fulfilled, it is mandatory to provide intermediate islands. These islands shall have traffic lights with their own systems of visual and acoustic signals.
5. Audio signals encourage safer crossing behaviour among children and regular pedestrians as well.

### 3.9 Tactile Guiding Surface Indicators (TGSIs)

Tactile paving should be used on access routes to provide warning and guidance to people with visual difficulties. The need for TGSIs is critical and requires to be laid out with a holistic integration with built environments. Partial and incorrect laying of TGSIs may cause inconvenience and may be hazardous for persons with visual impairments.

TGSIs should be well integrated and appropriately placed into external and internal spaces right from the inception stage of a built environment. It is recommended to make TGSIs part of the access route plan. For existing built environments too tactile path interventions need to be done in a phase wise manner to make infrastructures completely accessible for persons with vision impairments.





Image 3.17 Accessible transportation environment with Tactile Pavers with good visual contrast  
Photo Credits: DMRC, New Delhi



↑  **निकास**  
**Exit**

- म्युनिसिपल कॉलोनी Municipal Colony
- मॉडल टाउन - III Model Town -III
- छत्रसाल स्टेडियम Chhatrasal Stadium

**2**  
गेट न.





built environments too tactile path interventions need to be done in a phase wise manner to make infrastructures completely accessible for persons with vision impairments.

### 3.9.1 Clear continuous accessible path of travel

In essence, a clear continuous accessible path of travel is one that provides a dedicated pedestrian space which is free from barriers, hazards or obstructions

### 3.9.2 Types TGSIs's

1. This is one form of tactile indicators which, in essence, provides the blind or visually impaired a physical cue. It is detectable either underfoot or by the use of a white cane. Tactile ground surface indicators are only one source, amongst many, of orientation information. Unlike some other tactile indicators which are basically generic in nature, tactile ground surface indicators have a specific function and impart specific information about the immediate surroundings.
2. Tactile ground surface indicators act

as, and are interpreted as landmarks. There are two types of tactile ground surface indicators:

- a.Warning indicators; and
- b.Directional indicators.

### 3.9.3 Tactile Warning Indicators (Dot-type)

Warning indicators, as the name suggests, warn of either a hazard or a destination. For example, a warning indicator near the edge of a staircase landing warns of the edge of the landing which, otherwise, would pose a significant hazard to a pedestrian with low vision. As the person approaches the edge, the tactile warning treatment will be identified either by the white cane or underfoot, thus warning of an impending drop to the staircase. (Refer Fig: 3.13 a)

### 3.9.4 Tactile Guiding Indicators (Line-type)

Tactile guiding or directional indicators are used to direct the user from one point to another along a safe path of travel. They are only required when there are insufficient cues from other sources

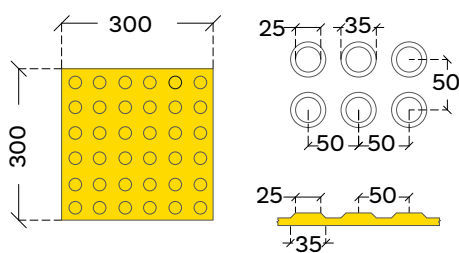


Fig a: Warning Indicators

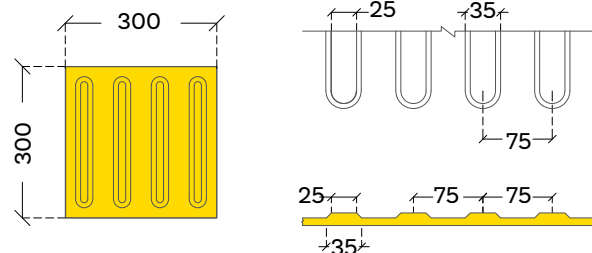


Fig b: Guiding Indicators

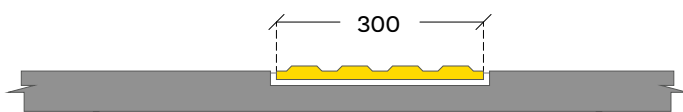


Fig c: Tactile Paver Section

Figure 3.13 Tactile guiding surface indicators (TGSIs) detail

to achieve the same result. For example, a directional indicator may be used in an open pedestrian plaza to indicate a clear path of travel in the absence of any other cues. (Refer Fig: 3.13 b)

### 3.9.5 Position of TGSIs

1. The decision to apply tactile ground surface indicators will always have to be made in light of the particular circumstances applicable at any given site. In making such decisions, consideration should be given to the orientation and mobility strategies and techniques adopted by people with visual impairments and the potential hazards and barriers existing at a given location. However, there are some obvious situations where tactile ground surface indicators must be applied.
2. Warning treatment may be required at:
  - a. Hazardous locations, such as steps, stairs, railway platforms, pedestrian crossings, waterfront edges, etc.
  - b. Destinations to provide information about the location of amenities such as ticketing machines, service counters, phone booths, etc.
3. Directional treatment may be required to assist with:
  - a. Direction, that is, to indicate a clear continuous accessible path of travel; and
  - b. Location, that is, to provide assistance to locate a target such as a pedestrian crossing, entrance to a public building, ticketing machine or phone booth.

### 3.9.6 Principles of application

When considering the application of tactile ground surface indicators, four major principles must be taken into consideration.

#### 1. Minimalist application

Tactile ground surface indicators act as landmarks. As such, its application must be targeted and minimised as far as possible. Widespread ad hoc application of tactile ground surface indicators will confuse rather than inform, and will compromise the effectiveness of the specific cue being provided.

#### 2. Dimensions

The dimensions of the treatment are critical. Remembering that tactile ground surface indicators will be identified underfoot, it is important to ensure that a minimum depth of treatment is applied. To be detectable underfoot, the treatment must make contact with the ball of the foot. To ensure this will always occur, treatments must have a minimum depth of 600 mm in the direction of travel. This dimension applies to both warning and directional treatments at their initial point of identification.

#### 3. Colour and Luminance Contrast

Tactile ground surface indicators should be coloured and contrast in luminance with their surrounding surfaces. This will greatly assist those using their residual vision to move around.

Many people with low vision also have difficulty distinguishing between different colours, particularly if they appear next to each other. For example, the "tomato effect", that is, red on green, does not provide adequate luminance contrast and, as such, will be extremely difficult to identify. For this reason, a minimum luminance contrast of 30% is required to fulfill this principle. However, a luminance contrast of 50% is recommended.



Table 3.3 Luminance Contrast

TACTILE GROUND SURFACE INDICATOR	LUMINANCE CONTRAST REQUIREMENT
Integrated	0.30 or 30%
Discrete	0.45 or 45%
Composite Discrete	0.60 or 60%

There are different ways in which tactile ground surface indicators can be installed and with different luminance contrasts. Tactile ground surface indicators can be installed as:

- a. Integrated units : tile-like units where the background and raised domes are made of the same material;
- b. Discrete units : separate domes installed to provide the effect of a tile on an existing surface. The raised domes are inserted into the background surface; and
- c. Composite discrete units : similar to discrete units, with the exception that the truncated sides of the domes or the directional markers are of a different colour to the upper surface. The composite discrete tactile ground surface indicator is generally manufactured this way to incorporate a superior slip-resistant surface.
- d. Raised domes are inserted into the background surface; and
- e. Composite discrete units : similar to discrete units, with the exception that the truncated sides of the domes or the directional markers are of a different colour to the upper surface. The composite discrete tactile ground surface indicator is generally manufactured this way to incorporate a superior slip-resistant surface.

The luminance contrast requirements of each type of tactile ground surface indicators is as in table 3.3

#### 4. Orientation and Position

- a. In general, a warning treatment should be applied in a perpendicular direction, which is at 90 degrees, to the line of approach or to the target object. In addition, a warning treatment should be set back 300 mm from the hazard or target object.
- b. A directional treatment is usually applied along the centre line of the indicated path of travel and must provide a minimum dimension of 450 mm from the edge of the accessible route, corridor or path.

#### 3.9.7 Application of TGSIs

1. TGSIs shall be applied in both external and internal environments of built infrastructure. Keeping the above mentioned guiding principles in consideration, they shall be placed in external spaces at kerb ramps, pedestrian crossings, access routes, side walks, walking trails, across pedestrian mobility routes alongwith entrance steps, ramps or any level changes in diverse typologies of built environments.
2. For internal environments, they shall be placed before staircases, escalators, ramps, lifts, corridors and as guiding

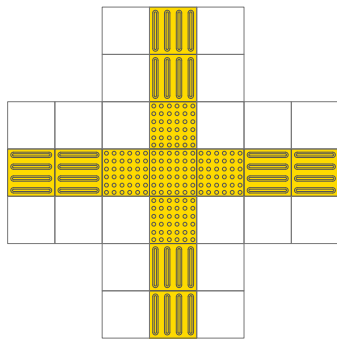


Fig a: '+' shaped junction

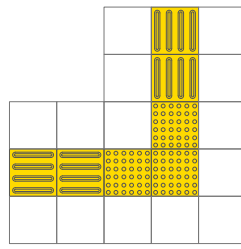


Fig b: 'L' shaped junction

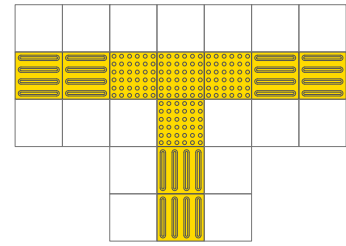


Fig c: 'T' shaped junction

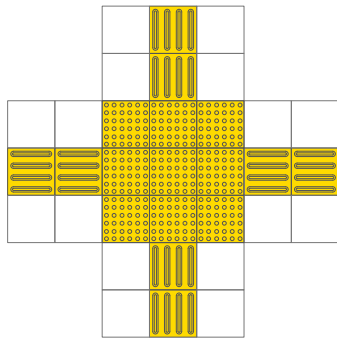


Fig d: 'Y' shaped junction

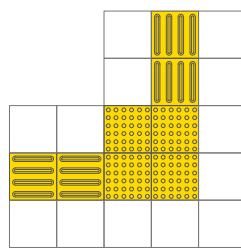


Fig e: 'X' shaped junction

Figure 3.14 Typical TGSJ junction details

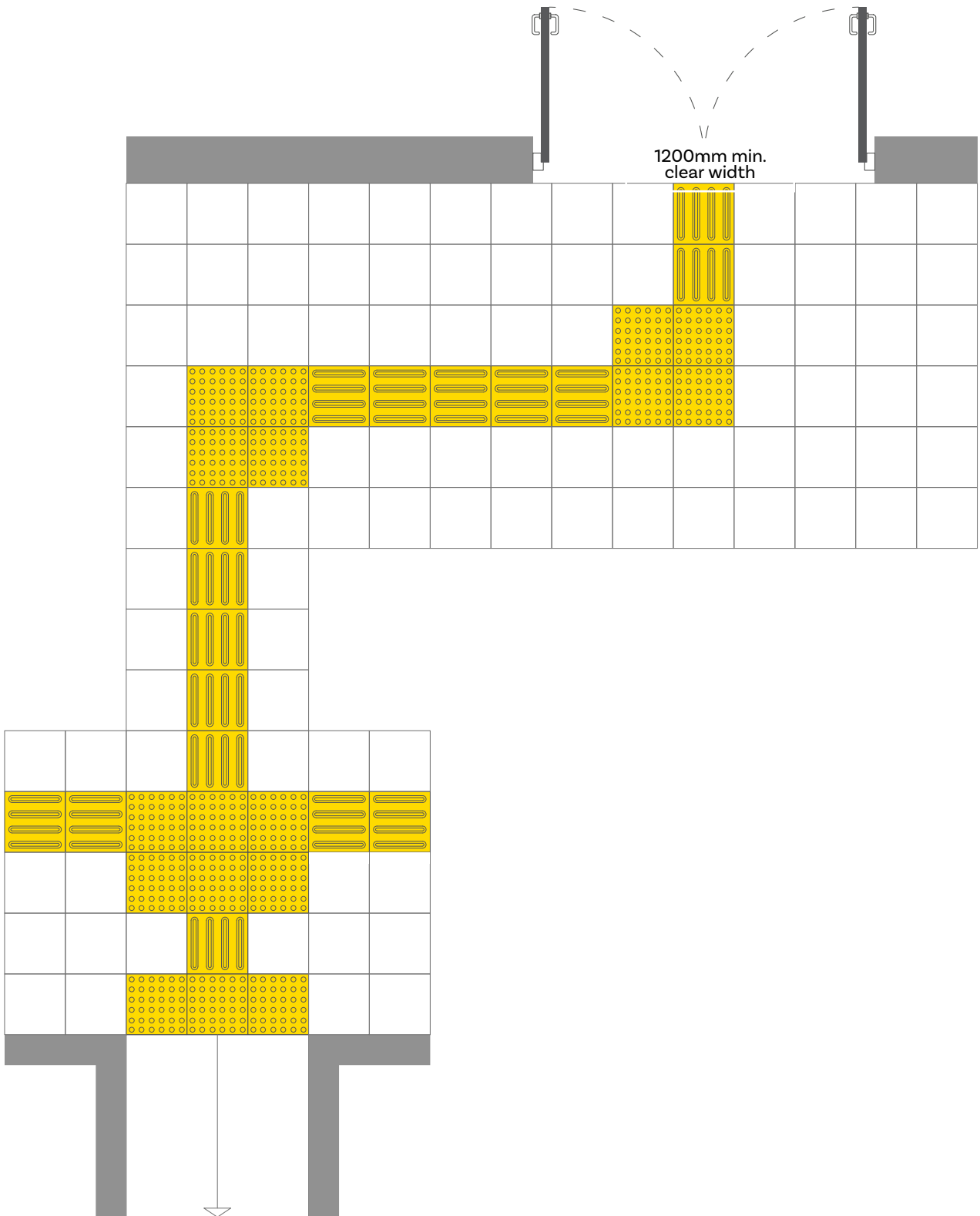


Figure 3.15 Configuration and layout of tactile guiding and warning tiles



routes for internal mobility and navigation in all building typologies. TGSI's also require to be extended strategically into washrooms to guide access to atleast one WC cubicle, urinal and a wash basin.

3. TGSI's shall be laid as per Fig: 3.14 on various junctions including '4', 'L', 'T', 'Y' and 'X' types of configurations for directional and warning indicators.
4. Care must be taken to ensure that there are no obstacles, such as trees, poles or uneven surfaces, along the route traversed by the guidance blocks.
5. Also, there should be clear headroom of at least 2.1 meters height above the tactile guidance blocks, free

of protruding objects such as overhanging tree branches and signage, along the entire length of the walk.

6. Two rows of tactile warning indicators should be installed across the entire width of the designated accessible pathway, before intersections, building entrances, obstacles such as trees, and each time the walkway changes direction.
7. Warning blocks could be placed 300 mm at the beginning and end of the ramps & stairs, at landings and entrance to any door. However, it does require contextual planning to lay TGSI's in diverse built environments to ensure safety for persons with visual impairment.

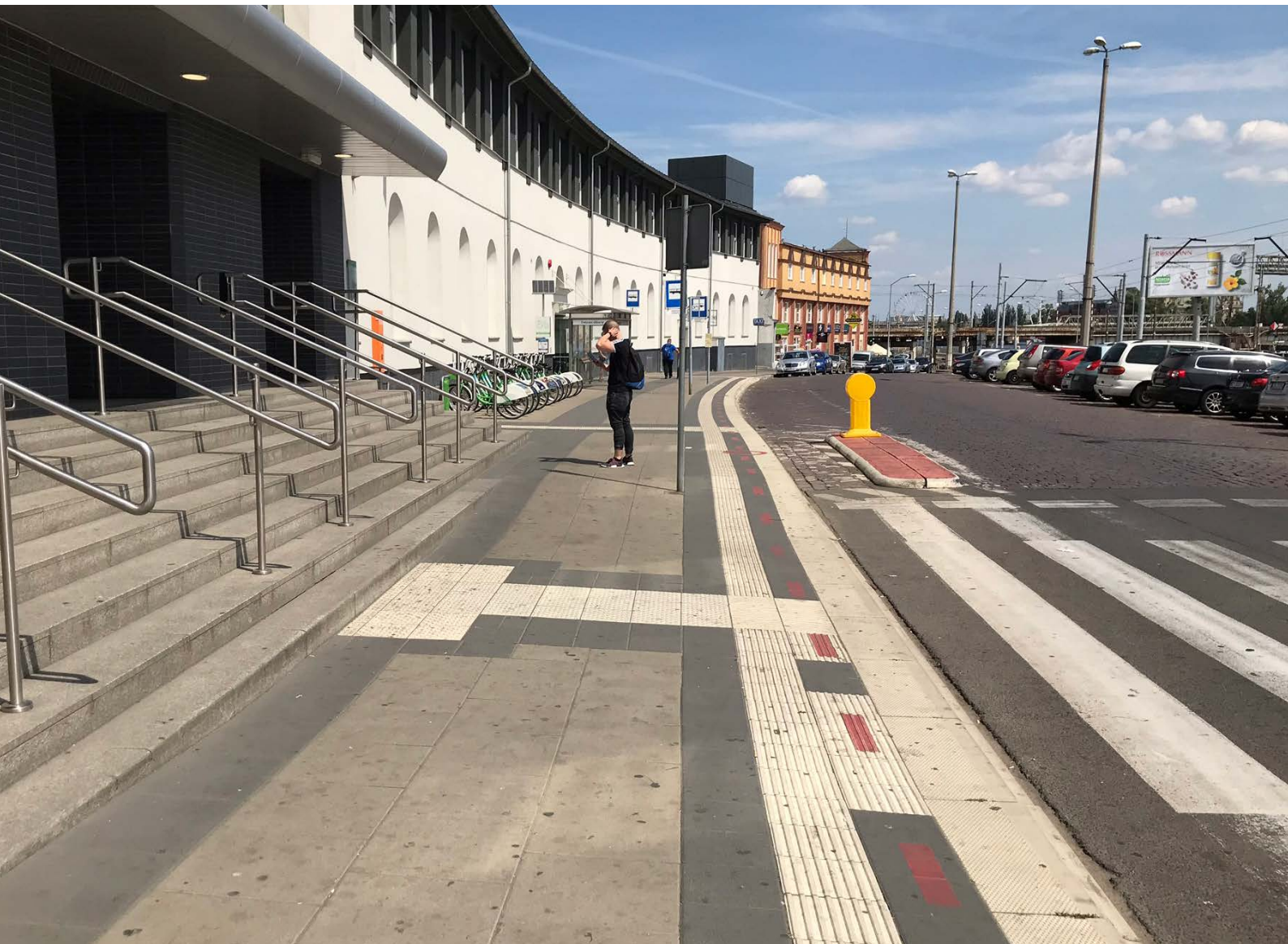


Image 3.18 Tactile pavers road layout  
Photo Credits: Dr. Gaurav Raheja



दिव्यांगजन सशक्तिकरण विभाग  
सामाजिक न्याय  
एवं  
अधिकारिता मंत्रालय  
भारत सरकार

Department of Empowerment  
of Persons with Disabilities  
Ministry of Social Justice  
& Empowerment  
Government of India

स्वावलम्बन  
Swavlamban

स्वावलम्बन  
Swavlamban

Image 3.19 TGSi pathway in horizontal circulation  
Photo Credits: Dr. Gaurav Raheja

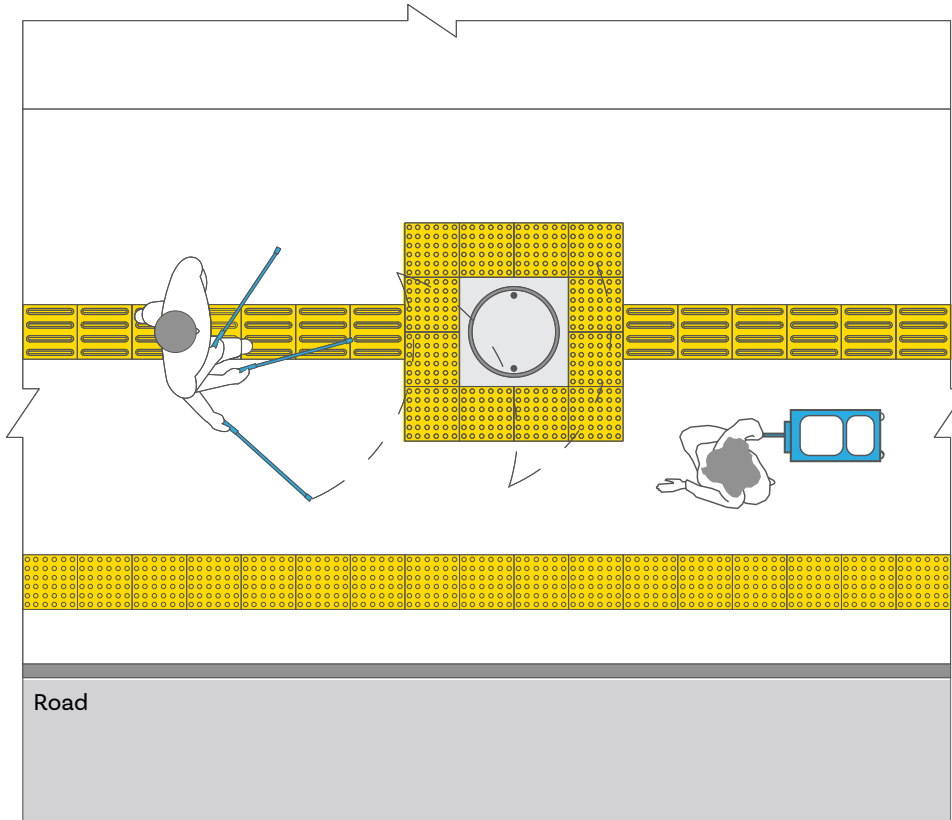


Fig a: TGS around circular profile (Manhole cover)

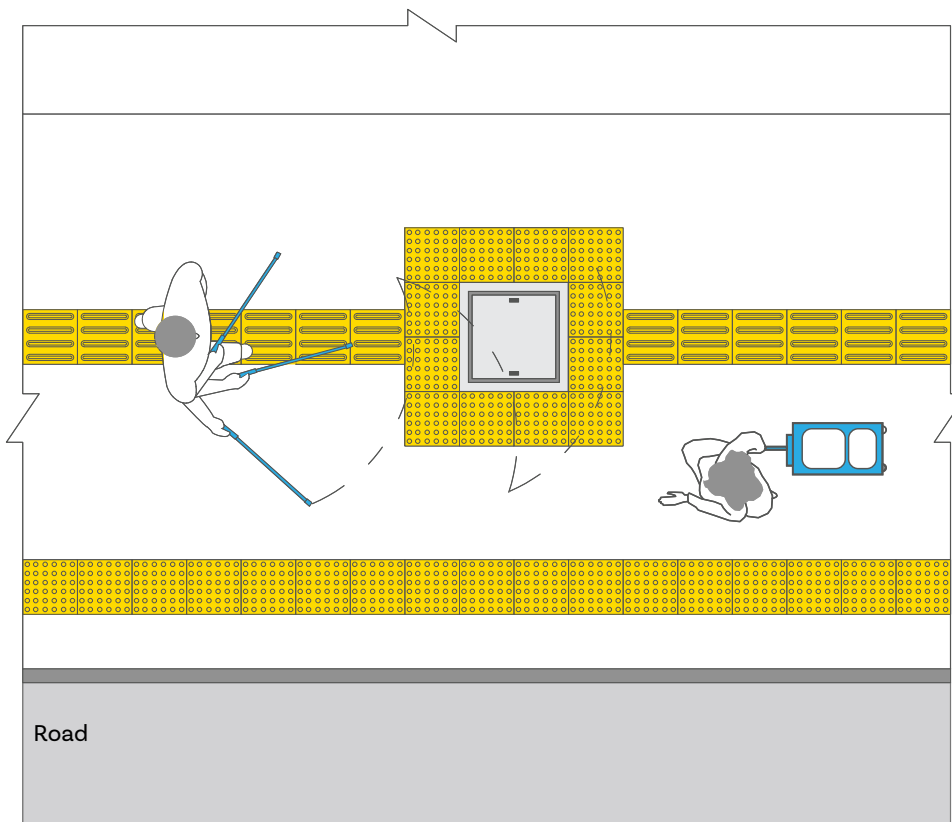


Fig b: TGS around square profile (Manhole cover)



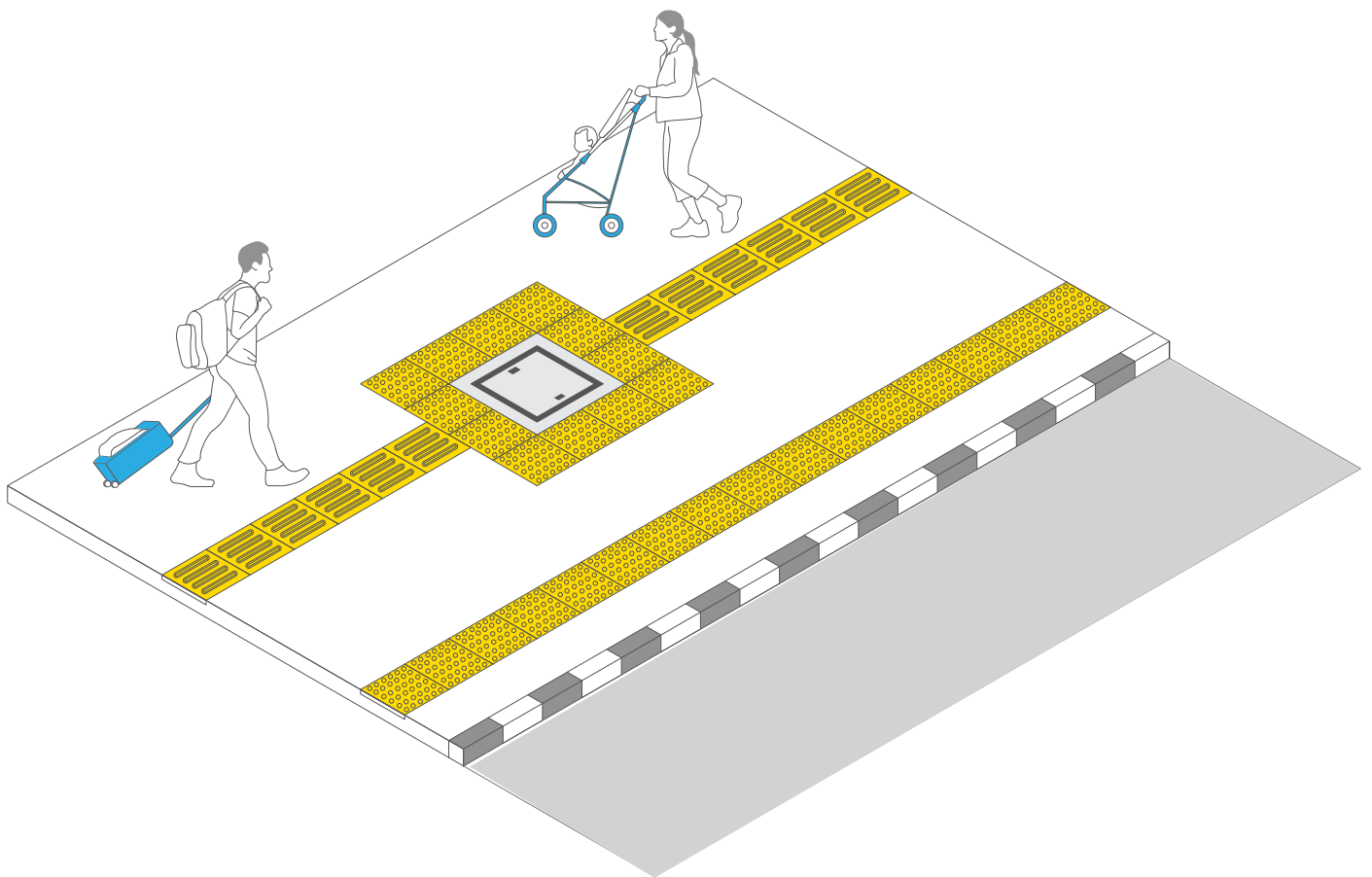


Fig c: TGSi around square profile (Manhole cover) (3D View)

Figure 3.16 TGSi layout details around manhole covers on sidewalks

### 3.9.8 Materials

1. Tactile ground surface indicators are produced in a range of materials including concrete, ceramic, rubber, cork, steel and various resins. Some types are supplied in a tile format while others are applied with a spray-on technique.
2. When making a judgement as to which type to use, consideration should be given to:
  - a. Internal versus external applications;
  - b. New versus retrofit applications; and Availability and installation

requirements.

### 3.9.9 Impact of TGSi's on other pedestrians

A considerable amount of research has taken place to support the dimensional requirement for tactile ground surface indicators. This research has confirmed that the provision of tactile ground surface indicators at a dimensional height of 5 mm is sufficient to impart adequate tactile information whilst at the same time not adversely impacting on other pedestrians. The 5 mm pavement variance is generally accepted to be within the tolerances for pedestrian facilities.





Image 3.20 Accessible ramps at building entrance  
Photo Credits: Dr. Gaurav Raheja



### 3.10 External Ramps

Ramps are an extremely crucial element of a built environment providing an accessible choice for mobility for those with limited mobility or other challenges to encounter level changes. However, it is equally crucial to understand that ramps need to adhere to the given guidelines to enhance accessibility with safety through their apt location, configuration, slopes or gradients and other specifications. Well-designed ramps provide an inclusive access to persons using wheelchairs, parents with baby strollers, individuals using rollators or walking frames, baggage trolleys and other diverse forms of human existence. It is to also understand that ramps need not negate the requirement of steps in various level changes of built environment, as they provide an element of accessible choice.

It should be attempted for all built forms under design stage to integrate ramps as part of site planning and landscapes in the external spaces to emerge as universally designed spaces and elements.

#### 3.10.1 General

1. Ramps allow persons in wheelchairs to move from one level to another. However, many ambulant Persons with Disabilities negotiate steps more easily and safely. Hence, it is preferable to provide accessibility by both steps and ramps.
2. The horizontal run of ramps

shall adhere to Table 3.4 for the recommended length of runs.

3. Where there is a large change in elevation that requires multiple ramps and landing combination, other solutions such as elevators should be considered
4. Single row of tactile warning blocks should be placed at the beginning and end of each ramp and at the beginning and end of each run.
5. External ramps should ideally be covered ensuring access amidst challenging weather conditions like rains, scorching heat, etc.

#### 3.10.2 Gradient

1. It should be noted that the gradient should be constant between landings. The recommended gradients for ramps are given in Table 3.4 below
2. Curved ramps should be avoided. If used, the recommended gradient should be equal or gentler than 1:16.
3. For ramp gradients between those specified in Table 3.4 (for example for a gradient like 1:13 or 1:18), the intervals may be obtained by linear interpolation.
4. The number of horizontal runs of ramp should be limited to 4, i.e. with 3 intermediate landings.
5. Ramp gradients wherever possible should prefer a slope taking in consideration an independent or

Table 3.4 Gradient and Length of Ramps

GRADIENT OF RAMP	1:12	1:14	1:15	1:20	NOT GENTLER THAN 1:25
Maximum length of horizontal run-in metres	6	9	11	15	18



unassisted movement in wheelchair. This is in line with one of the seven principles of Universal Design i.e. Low Physical Effort.

### 3.10.3 Width

The minimum clear width of a ramp should be 1200 mm.

### 3.10.4 Surface

1. Ramps and landing surfaces should be slip resistant in their surface finish and also follow a flat surface profile.
2. Ramp surfaces should avoid any form of rumblings or corrugations as part of construction detailing as they cause immense inconvenience and sometimes a body pain to ones with diverse disabilities.
3. Outdoor ramps and their surface should be designed to prevent water from accumulating on the walking surfaces.
4. The ramp surface material should also have contrasted colour surface ensuring ease for persons with low vision and other forms of visual impairments.
5. The ramp surface should be flat and free from any rumblings or corrugations.

### 3.10.5 Landings

Landings should

1. Be configured at the top and bottom of each run and where the ramp run changes direction.
2. Be provided at regular intervals of not more than 9000 mm of every horizontal run.
3. Have a level platform of size not less

than 1200 mm x 1500 mm.

### 3.10.6 Handrails

Handrails on the ramps must adhere to the guidelines as specified in Section 3.11.

### 3.10.6 Edge Protection

The key purpose of an edge protection is to ensure safe movement of wheeling devices while protecting the front wheels from slipping out of the ramp edges. All ramps and landing which are not adjacent to a wall must have an edge protection with either of the following specifications:

1. A raised kerb with a minimum height of 75mm.
2. A raised barrier with its lower edge at 75 mm or less from the ramp or landing surface.
3. A rail with the bottom edge at 75 mm or less from the ramp or landing surface.
4. In case where ramps are provided inside the building to connect various floors with one another, they must be supported by providing appropriate signage along with tactile and Braille information be provided either on the adjacent walls or on the handrail extensions to identify the floor levels.

This should be done for office buildings, shopping complexes, sports complexes, hotels, hostels, residential buildings, hospitals, schools and other educational buildings, transport stations, etc.

### 3.11 Handrails and Grab Bars

Handrails/ grab bars are extremely important features and must be designed



Image 3.21 Accessible horizontal circulation with handrail  
Photo Credits: Dr. Gaurav Raheja



to be easy to grasp and to provide a firm and comfortable grip so that the hand can slide along the rail without obstruction. Many Persons with Disabilities, elderly and others with weak grips or balance require handrails/ grab bars to maintain balance or prevent serious falls.

Handrails are essentially referred to as rails for support in built environment elements like staircases, ramps or corridors. However, grab bars are being referred to as fixed or moving rails for support in built environment contexts like washrooms, shower areas, around doors, etc.

It is essential that all handrails / grab rails are adequately fixed since they are subject to considerable pressure on the rail during manoeuvring. In rural and semi-urban areas, indigenous materials such as bamboo/ wood/ other can be used for making handrails/ grab bars in various application areas of built environment. For e.g., washrooms, outdoor walking trails, etc.

Handrails may be provided with Braille/ Tactile markings at the beginning and the end to enhance access to wayfinding information to people with visual impairment. It needs to be standardised

and followed across all public building typologies esp. Transportation, Educational, Public offices, Healthcare and others.

**3.11.1 Handrails should:**

1. Be slip-resistant with round ends.
2. Have a circular section of 38-50 mm in diameter
3. Preferably have knurled surfaces.
4. Have a minimum clear space of 40-60 mm from the walls; 40 min. for smooth wall surfaces and 60 min. for rough wall surfaces
5. Be free of any sharp or abrasive elements; and
6. Be installed at a height of 750 mm to 900 mm.
7. Have continuous gripping surfaces, without interruptions or obstructions that can break a hand hold.
8. Be able to bear a weight of 250 kg.
9. Be manufactured from a material which contrasts with the wall finish (or use dark tiles behind light coloured rails), be not too warm/cold to the touch and provide good grip.

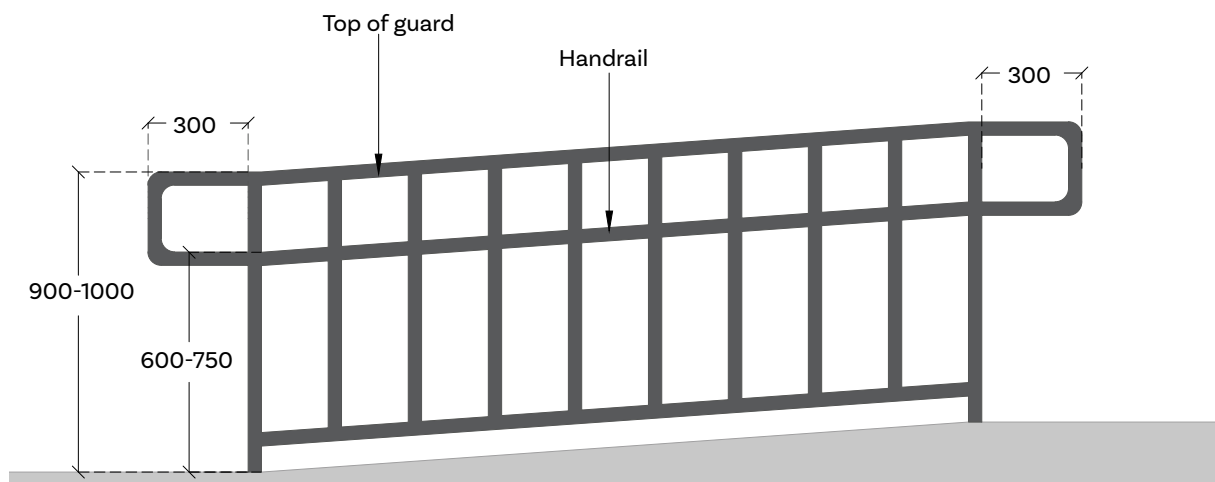


Figure 3.17 Handrail detail



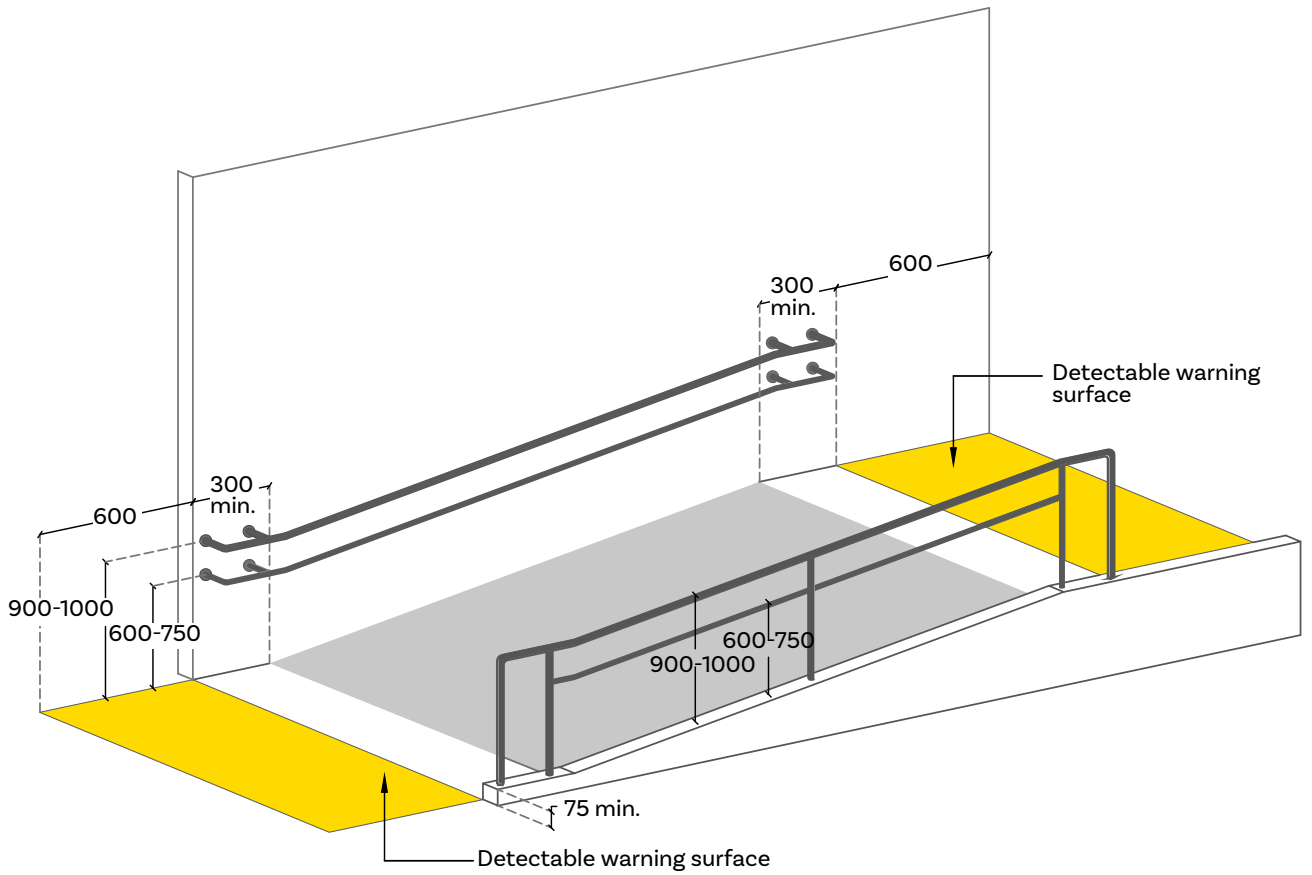


Fig a. Handrail returns to wall

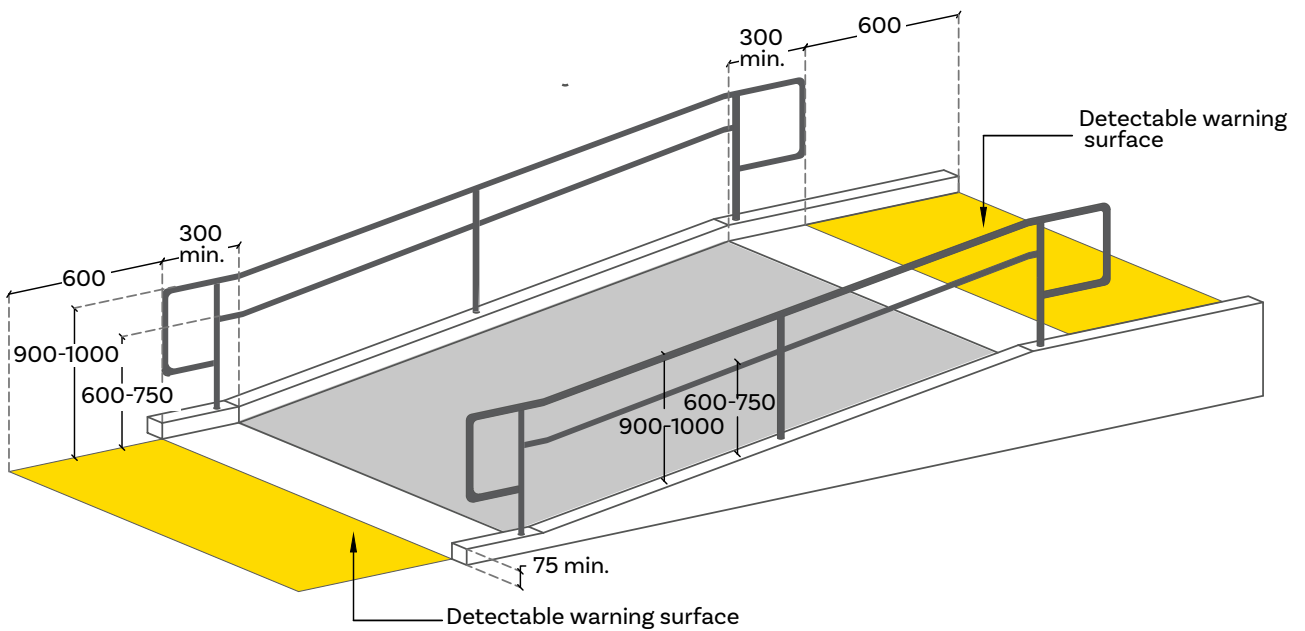


Fig b. Handrail returns to post

Figure 3.18 Handrail Extensions

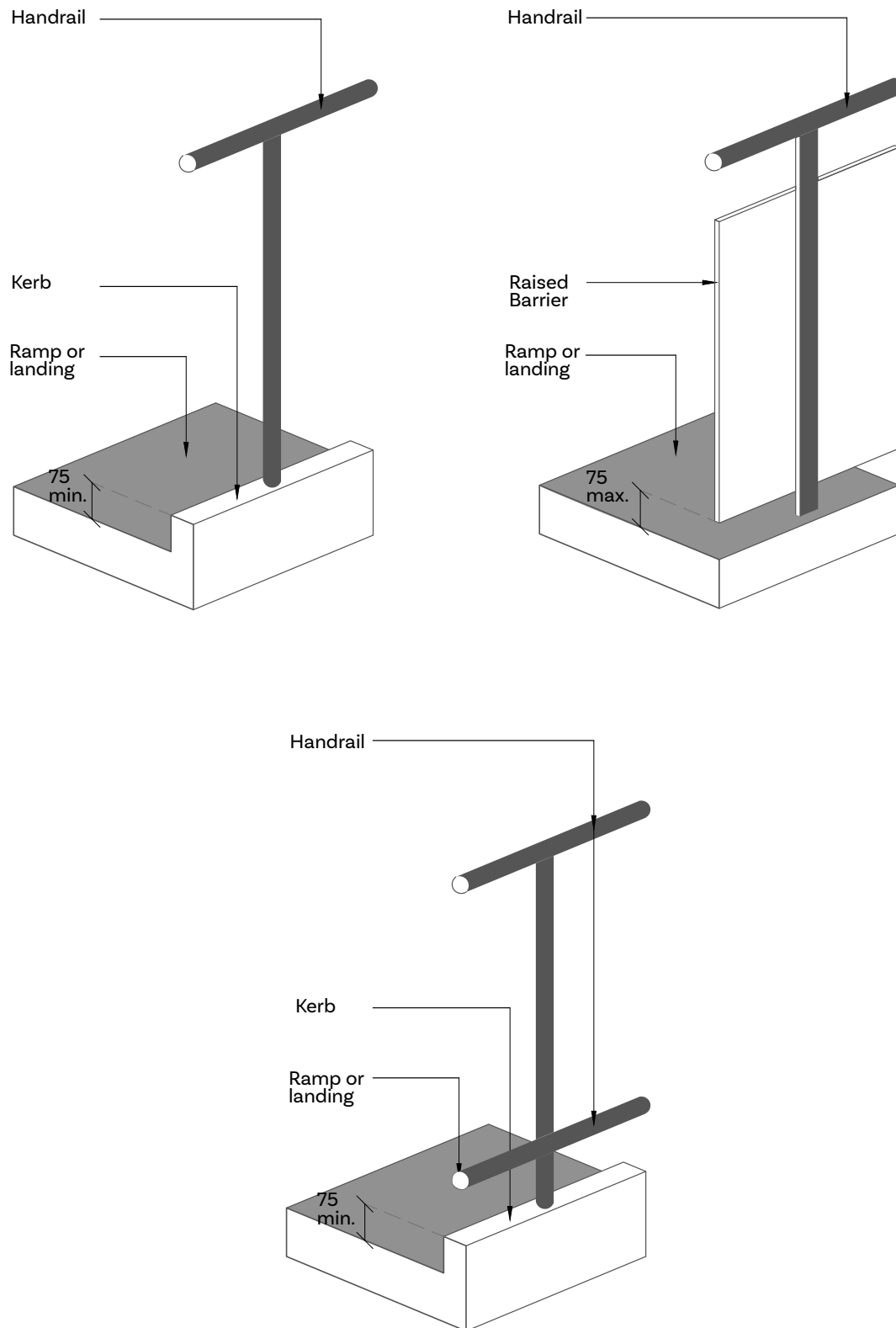


Figure 3.19 Sectional view of edge protection for ramps<sup>2</sup>

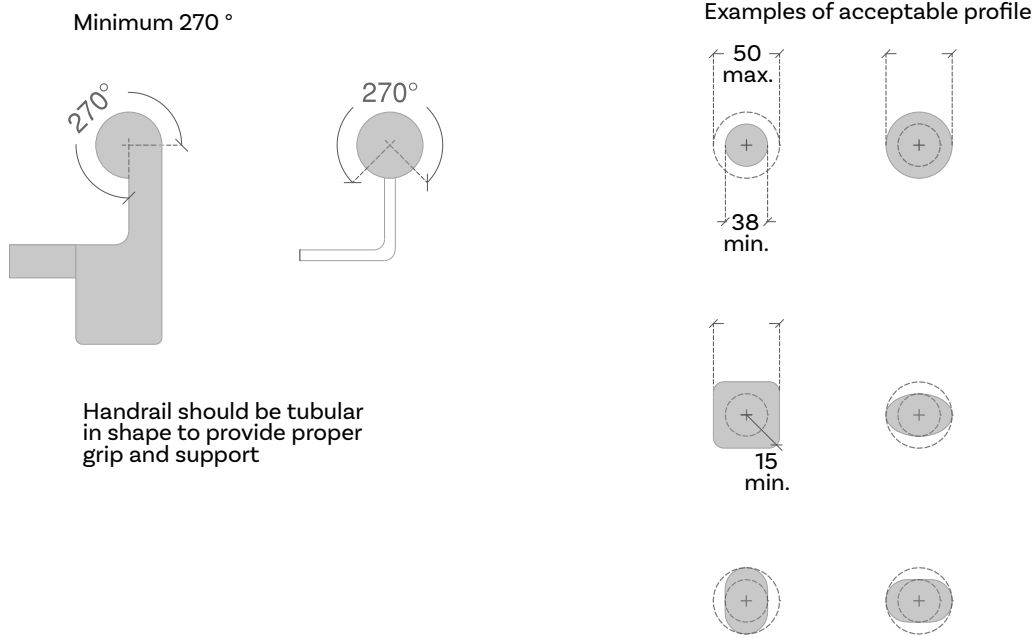


Fig a. Handrail cross-sectional profile

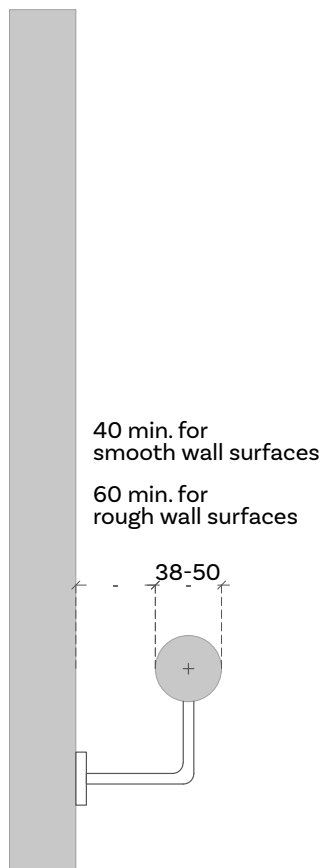


Fig b. Handrail clearance from the wall

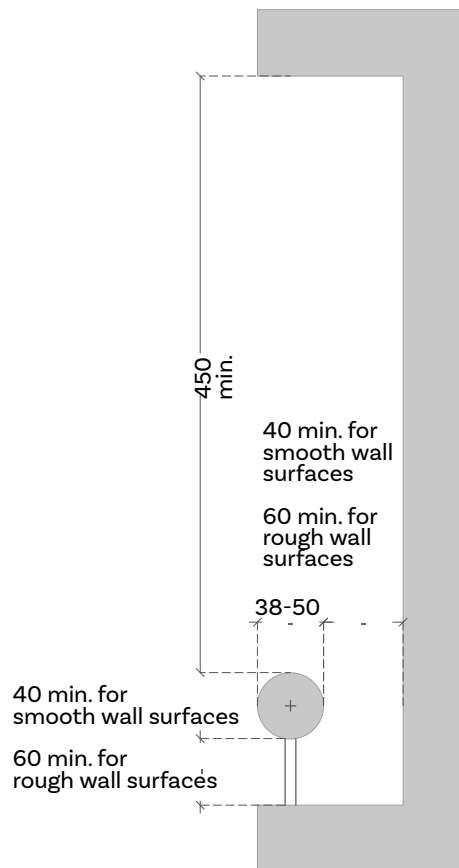


Fig c. Handrail in recess

Figure 3.20 Handrail profiles and fixing details



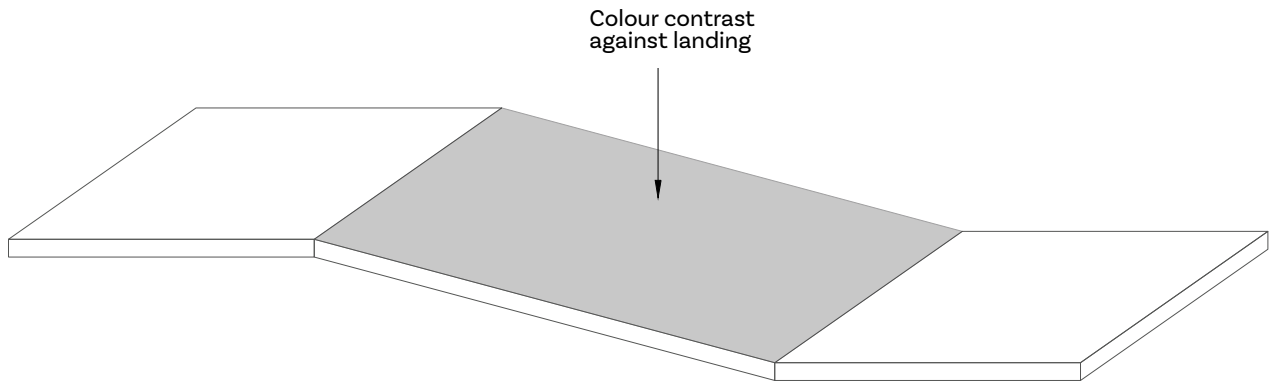


Fig a. Use of colour contrast on landing

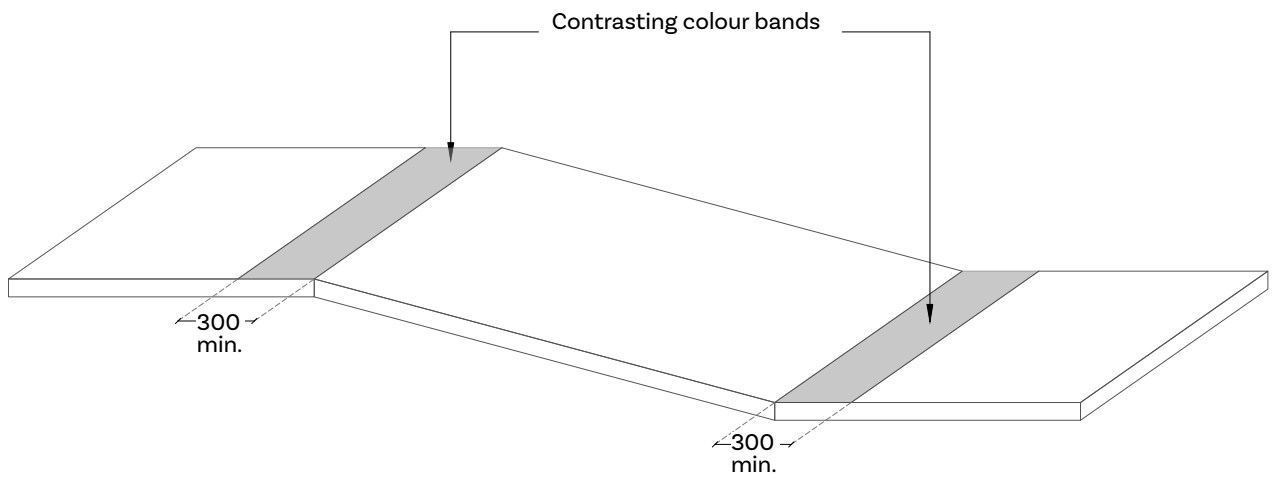


Fig b. Use of colour contrast or bands with colour contrast for rises from 15 to 200 mm

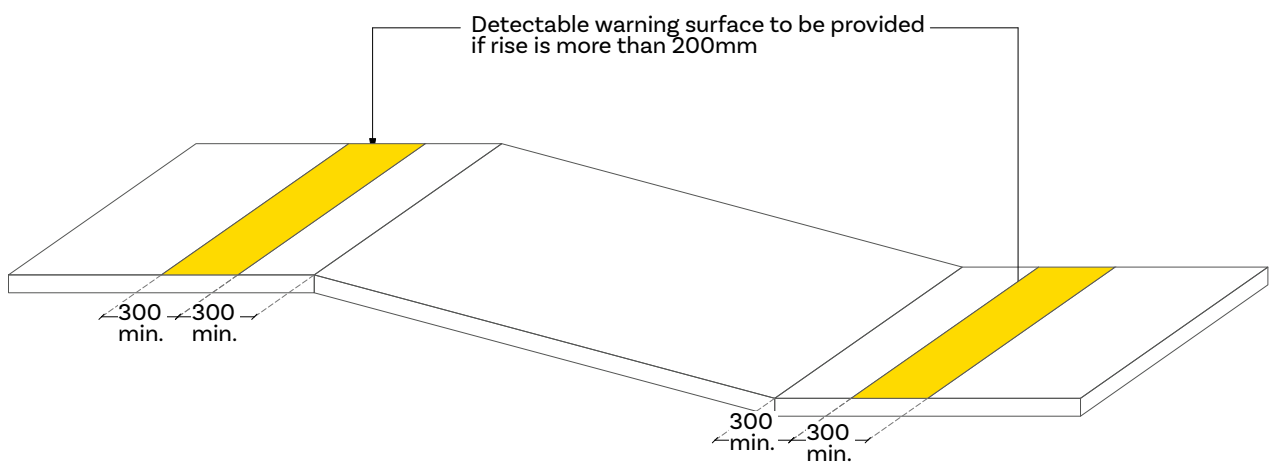


Fig c. Use of colour contrast or bands with colour contrast for rises from 15 to 200 mm

Figure 3.21 Contrasting colour, Coloured bands and detectable warning surfaces on ramps<sup>2</sup>

10. A ramp run with a vertical rise greater than 150 mm should have handrails on both sides.
11. The handrails shall be placed at a height of between 750 mm and 900 mm above the floor level. They must be continuous on both sides all through the ramp slopes and even at landings.
12. Handrail extensions as shown in the Fig: 3.20, should
  - a. Extend horizontally for a minimum distance of 300 mm beyond the top and bottom of the ramp to provide support for persons who may need help to negotiate the ramp.
  - b. Not project into another path of travel.
  - c. Must return to the wall, floor, or post.

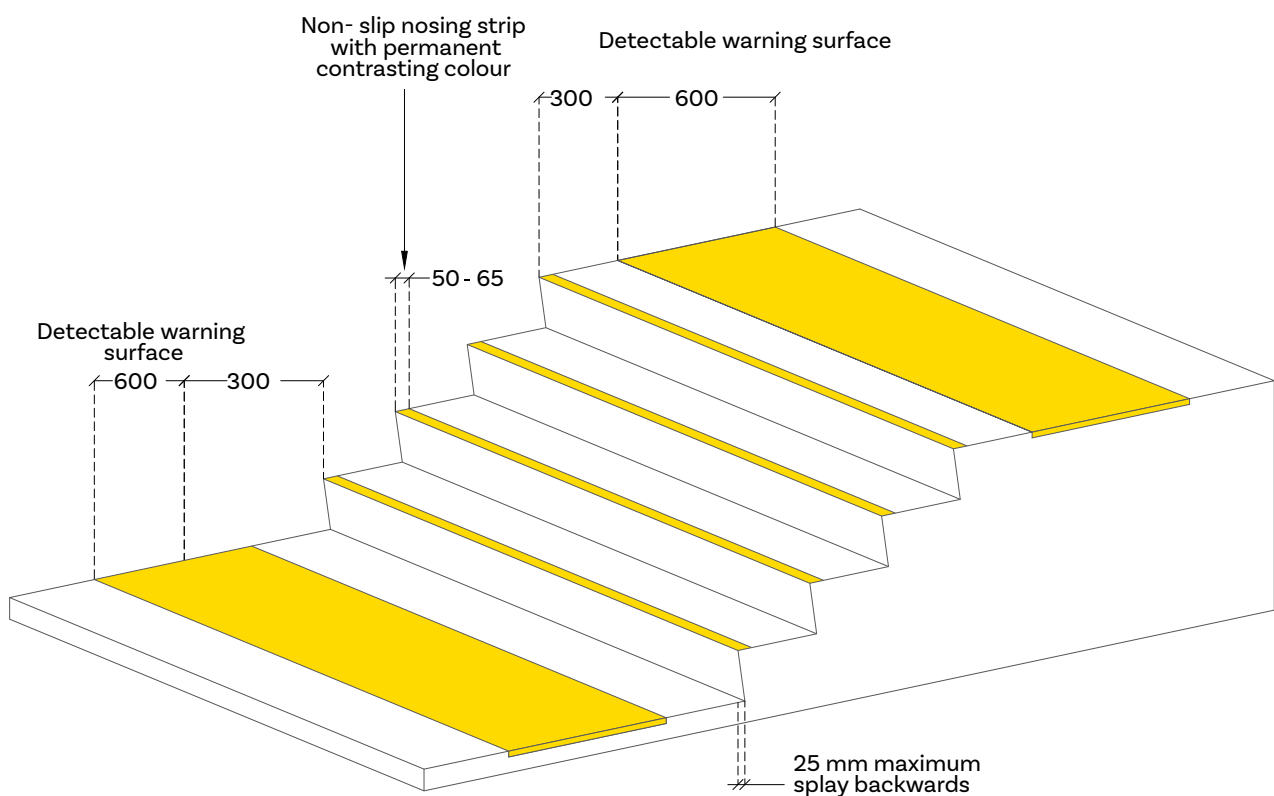


Figure 3.22 Staircase: Step profile and detectable warning strips

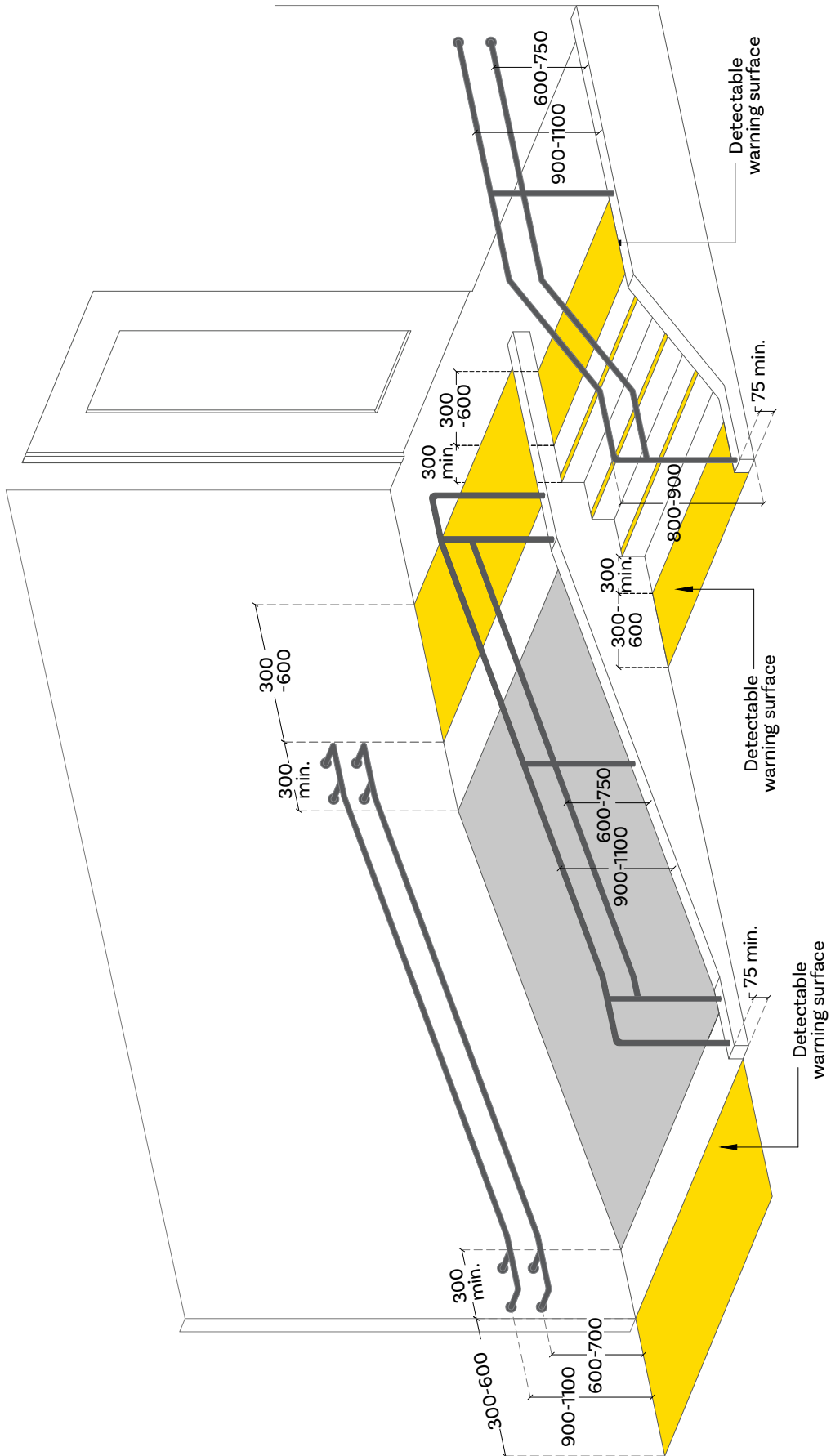


Figure 3.23 Ramp: Step profile and detectable warning strips



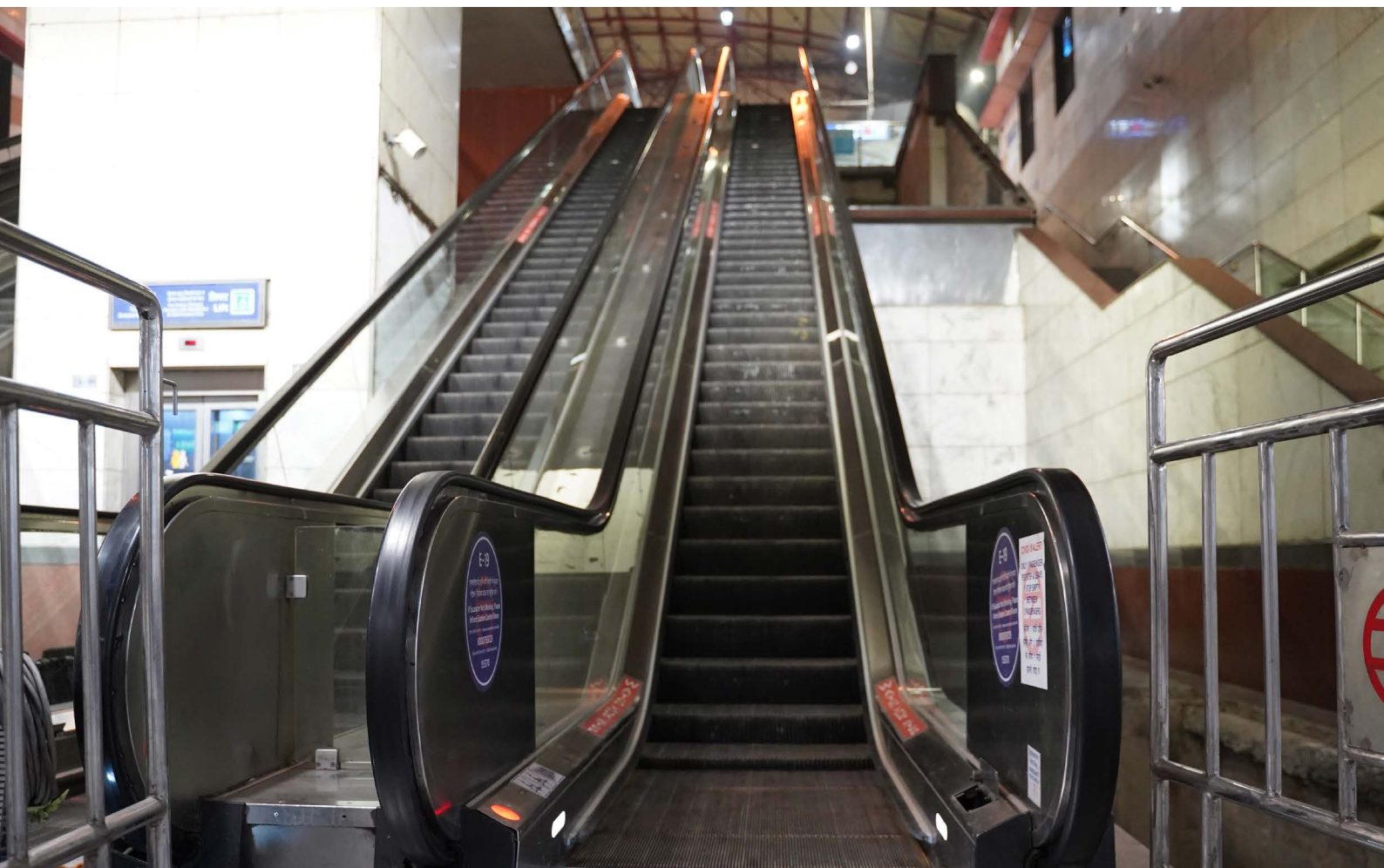


Image 3.22 Handrails as support in accessible staircase and escalators  
Photo Credits: DMRC, New Delhi



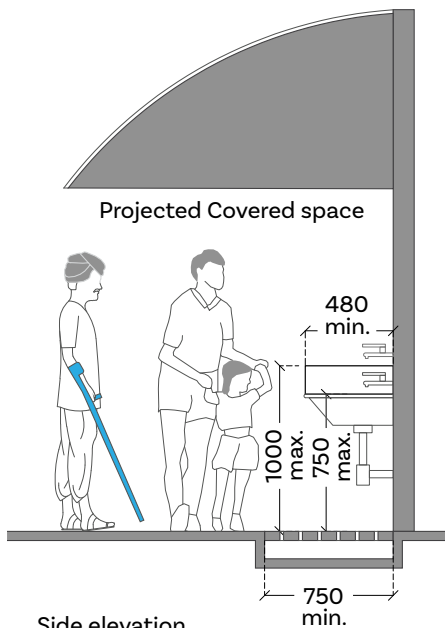
13. Handrails must be provided in a contrasting colour scheme with the background to ensure easy access and clear identification by diverse user groups including the ones with visual impairments.
14. The material for handrail or grab rail design shall consider the climatic factors and temperature as part of the built environment context. For eg. In climatic zones of extremely high or low temperature, metal surfaces for handrails would pose challenges to grip them. Likewise in high rain zones, rust proof materials shall be required to ensure hygiene and easy grip on handrails.
15. Public behaviour towards vandalism or abuse of handrails shall be dealt with stern actions.

### 3.12 Outdoor Drinking water provision

External environments need to make accessible provisions for drinking water for all users by providing adequate service

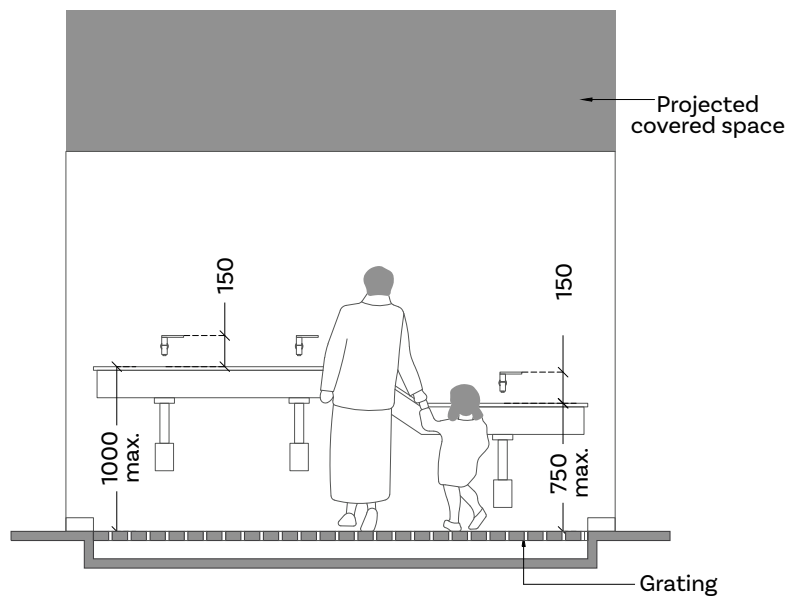
infrastructure for the same. Considering diverse socio cultural preferences of drinking water, it is important to design contextual choices of water access keeping sensitivity to the needs of persons with disabilities, children, elderly and other user groups. The following features are recommended as part of accessibility in external drinking water provisions (Refer Fig: 3.24, 3.25, 3.26) :

1. Access route to drinking water be well defined, well illuminated and supported with wayfinding signage.
2. The space should be well maintained, hygienic and safe to move around with a provision of minimum 900 mm wide apron around the water spouts.
3. Drainage covers, gratings and proper slopes to be provided for water spillage as per Section 3.6. To avoid water logging or muddy situations.
4. A clear space of 900mm x 1200mm be provided in front of the water fountains or faucets as maneuvering spaces for wheelchairs and other mobility devices like baby prams, rollators, etc.



Side elevation

Fig a. Drinking water fountain heights: Elevations



Front elevation

Figure 3.24 Outdoor water fountain

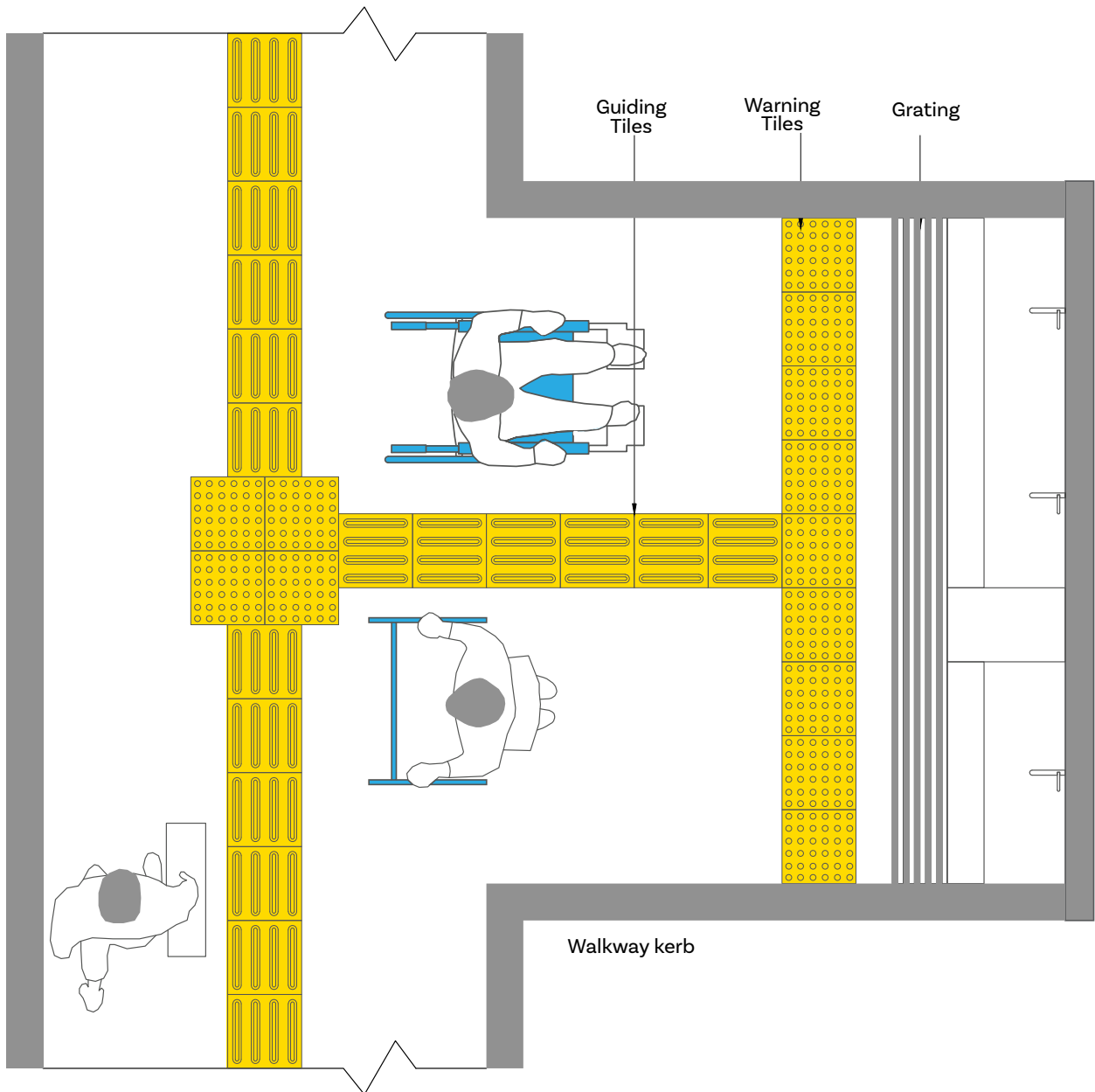


Fig b.TGSI layout around drinking water fountain (Plan)

Figure 3.25 Drinking water fountain details: Type A



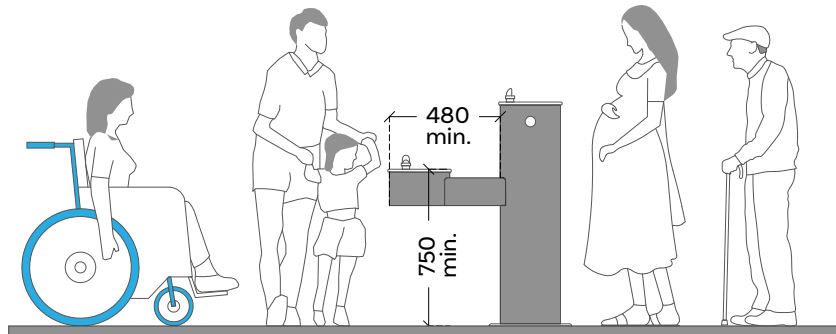


Fig a. Drinking water fountain heights (Side Elevation)

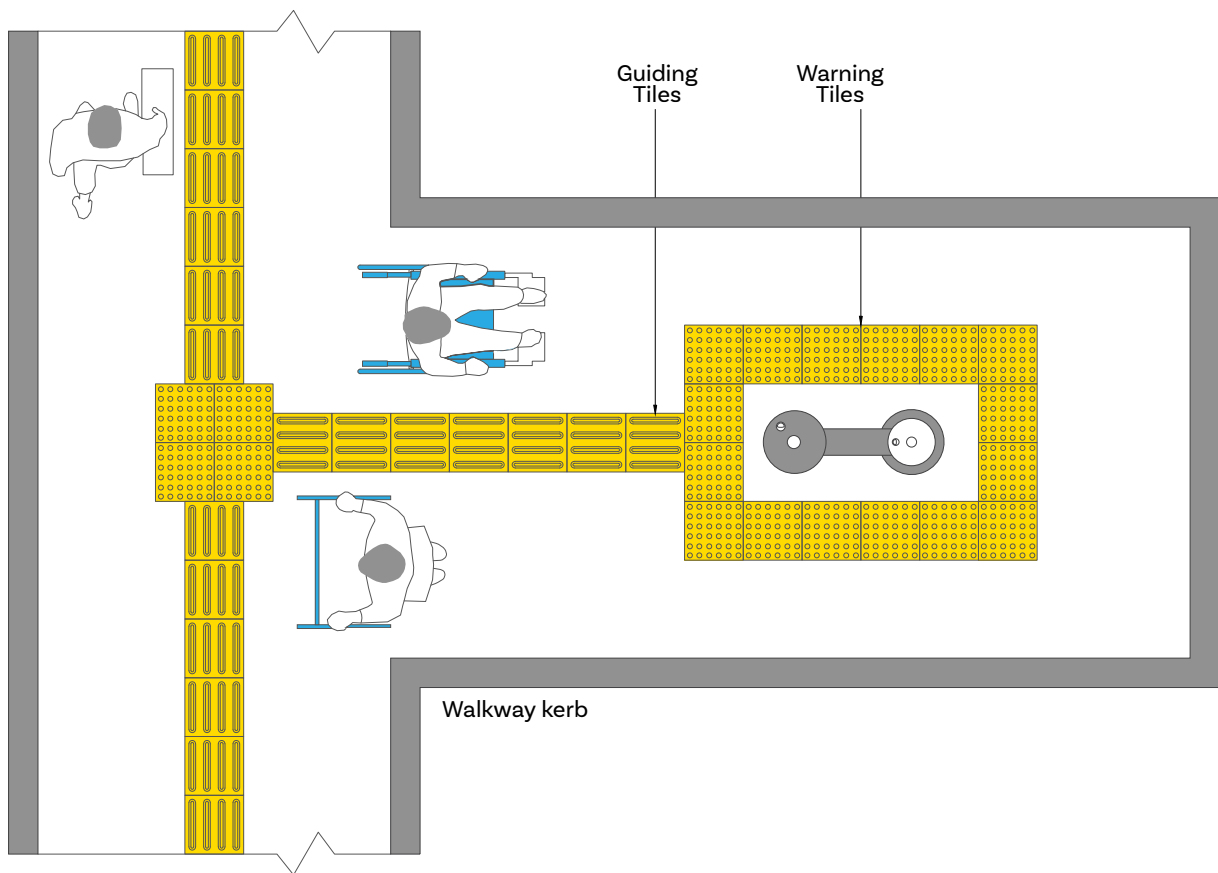


Fig b. TGS layout around drinking water fountain (Plan)

Figure 3.26 Drinking water fountain details: Type B



Image 3.23 Accessible drinking water provision  
Photo Credits: Dr. Gaurav Raheja

5. Drinking water outlets must have a clear knee space between the bottom of the apron and floor or ground of atleast 750mm wide, 200mm deep and 680mm -750mm high.
6. Freestanding or built-in-drinking water coolers or taps not having a knee space should have a clear floor space of at least 1200mm wide x 1200mm in front of the unit.
7. Of the multiple water spouts provided, atleast one should be at lower height of 750mm with clear knee space of minimum 680 mm for access to wheelchair users as in Fig: 3.24.
8. Water taps or faucets should be lever type for ease in use with grip related disabilities and also other situations of inability to use palms or hand grips.
9. While planning and designing water points in external environments, due attention needs to be given to material finishes and avoid flooring materials with slippery finishes underneath the water outlets.
10. The pathway to drinking water facility should be well lit and be in accordance with access routes as specified in Section 3.5.
11. Tactile guiding pathways along access routes should lead to the water points in external spaces for ease in access to persons with visual impairments.
12. Sensor based hands free taps or other new technologies of water fountains be contextually integrated in external environments for enhanced accessibility.

### 3.13 External Sanitary Provisions

Sanitary provisions in external spaces of built environments need to ensure

accessibility and responsiveness with a universal design approach. A complete sanitation system provision would typically include WC cubicles, urinals, hand wash facilities besides other support functions of baby changing spaces, baggage support among others. It requires various aspects to be considered to ensure a holistically accessible and inclusive sanitation experience by diverse user groups including persons with disabilities. This includes provision of adequate and appropriate information in accessible formats, accessible infrastructure with proper maintenance and allied services to use a washroom facility. It is important to acknowledge the diverse needs of users while planning, designing and retrofitting sanitary provisions for accessibility.

This includes sensitivity to the needs of persons with diverse disabilities including those using wheelchairs, ones with ambulant disabilities, visually impaired, hearing impaired, children, women, elderly, families and a wide range of others, in various situations of use in external environments. An overall experience of ease in access, safe usage and adaptive comfort in sanitation requires a careful implementation of accessibility standards, material specifications, support installations, maintenance services and an inclusive citizen behaviour or conduct.

#### 3.13.1 Information Accessibility for Sanitation

1. Access to clear information in diverse and legible formats at appropriate locations. This includes information design of wayfinding signage, facility signage and proper structuring of information to include persons with disabilities, transgender alongwith family friendly restrooms for children and elderly. Digital mapping of toilet infrastructures in external environments would further enable a



3. Absence of clear information causes an information barrier for various user groups. Provision of sanitary facilities like washrooms, baby changing stations, etc. need to be well indicated through pictograms, text in multiple languages and tactile formats.
4. Accessibility symbols for persons with disabilities, family friendly facilities and transgender be inclusively incorporated among other user groups for washrooms.
5. Information about status of washroom occupancy using red for occupied and green for vacant be extended into multi format communication to enhance levels of accessibility.
6. Emergency information signs to be well integrated into the toilet systems ensuring legibility and clarity at all times.
4. Of all WC cubicles as part of any integrated washroom complex, at least one fourth (twenty five percent) of the cubicles require to be Indian squat systems with adequate grab rail support. The infrastructure details for washrooms and their provisions may be further referred in Section 4.9.
5. Provision of baby changing facilities in both male, female and unisex accessible washrooms be made available across all sanitation facilities.
6. Faucets or Taps with lever type fixtures are recommended in all sanitary provisions to provide ease in operations to majority user groups. They should be operable with less than 22 N force.
7. Accessible door latching mechanism along with emergency alarms (both audio and visual alarms) remain critical elements of an accessible washroom.

### **3.13.2 Accessible Sanitation Infrastructure**

1. The washroom infrastructure in external environments involve creation of an access route to the toilet complex, adequate maneuvering spaces for wheelchairs, baby strollers and other assistive devices of diverse user groups in and around the sanitation facilities.
2. External environments in public spaces, parks, educational campuses, recreational settings, etc. requires to address adequate design of washrooms with independent cubicles for diverse user groups.
3. Sanitation infrastructure needs to sensitively respond to creation of accessible infrastructure facilities like urinals and WC's for diverse disabilities, body types, gender, age groups and socio-cultural aspects as per details specified in Section 4.9.

8. Sanitary spaces should maintain an adequate colour contrast of 30 points difference in LRV between flooring, walling and fixtures.

### **3.13.3 Accessible Sanitary Services**

1. Sanitary service provisions including illumination, maintenance, water supply, hygiene and other aspects remain an integral component of accessibility.
2. Adequate illumination levels with a min. of 100 lux in access routes leading to washrooms.
3. Regular maintenance checks and emergency support services need to be ensured with proper sensitisation of support staff and human resources.
4. Staff training and capacity building for provision of accessibility services



Image 3.24 Faucets: Not recommended



Image 3.25 Faucets: Recommended

in sanitation systems of our built environments is highly recommended to render a holistic and inclusive experience.

### 3.14 Street Furniture Elements

Street furniture also referred to as furniture in external environments includes various elements like seating, vending infrastructure, lighting fixtures, trash / litter bins, bollards, information signage, traffic signs, junction boxes, post boxes, etc. They serve an immense value to render accessibility support and conveniences to wider user groups but also as dedicated services in external environments. Therefore, their placement in external environments, design, availability and continued maintenance requires sensitivity through design, planning and it's usage by everyone ensuring greater accessibility for all.

Since diverse kinds of street furniture elements are regulated and maintained by different civic agencies and municipal bodies at an urban level, it is highly recommended to evolve mechanisms with better or centralised coordination systems. Aspects of space allocation to various street furniture elements, their placement, installation on site and regular servicing are recommended to be integrated through a coordinated systemic intervention.

If not well coordinated, the same elements could pose as barriers for majority including people with diverse disabilities, walking difficulties, parents with baby strollers and several others. It is therefore recommended to place the diverse street furniture elements in straight line, leaving a clear access path of minimum 900 mm for pedestrian walkability, wheelchair users, etc.

Citizen participation and public behaviour play an important role to contribute towards inclusive and accessible public space environments. Information design strategies need to promote a responsive use of street furniture ensuring safety and access for all.

#### 3.14.1 Outdoor Seating

1. Seating in external environments could be designed either as independent furniture or as built in features responding to the context. In either case, it is important to first identify the location and placement of furniture ensuring that it doesn't hinder the access route for pedestrian mobility including those on wheelchairs or prams, etc.
2. It should be provided at regular intervals of every 30 metres along access routes especially near level changes such as external steps or ramps. In recreational contexts, they should be placed in shelters to experience and enjoy the scenic views.
3. Seats with backrests are useful for additional support, and armrests, positioned approximately 200mm above seat level, are also useful to lean against, as well as assisting in getting in and out of the seat especially for elderly or those with assisted care.
4. Seats should be between 450mm - 500mm high.
5. Seating around trees in public spaces or parks, etc. with adequate design for accessibility can emerge to be inclusive resting spaces for all.
6. Seating locations should be well lit for safety and ease in access for all including persons with low vision.



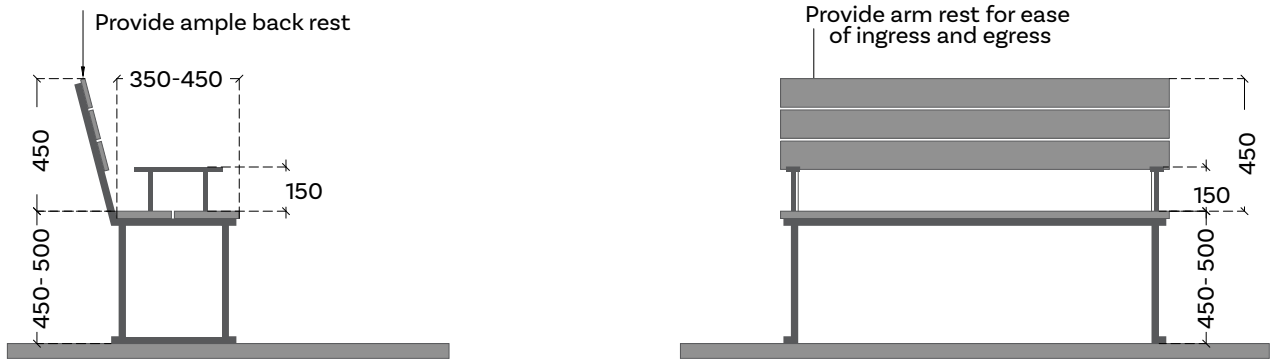


Figure 3.27 Outdoor seating: Elevation

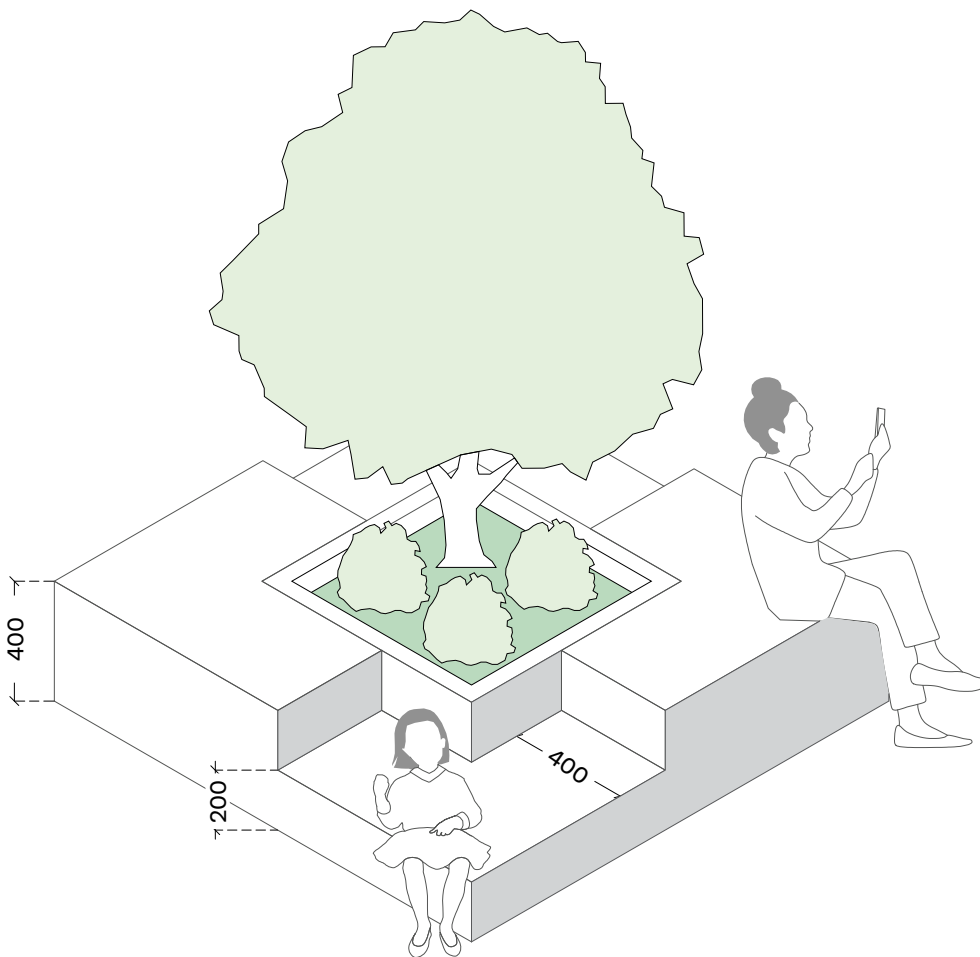


Figure 3.28 Outdoor seating: 3d visualization Type A





Image 3.26 Street Furniture typical example seating

Photo Credits: Dr. Gaurav Raheja



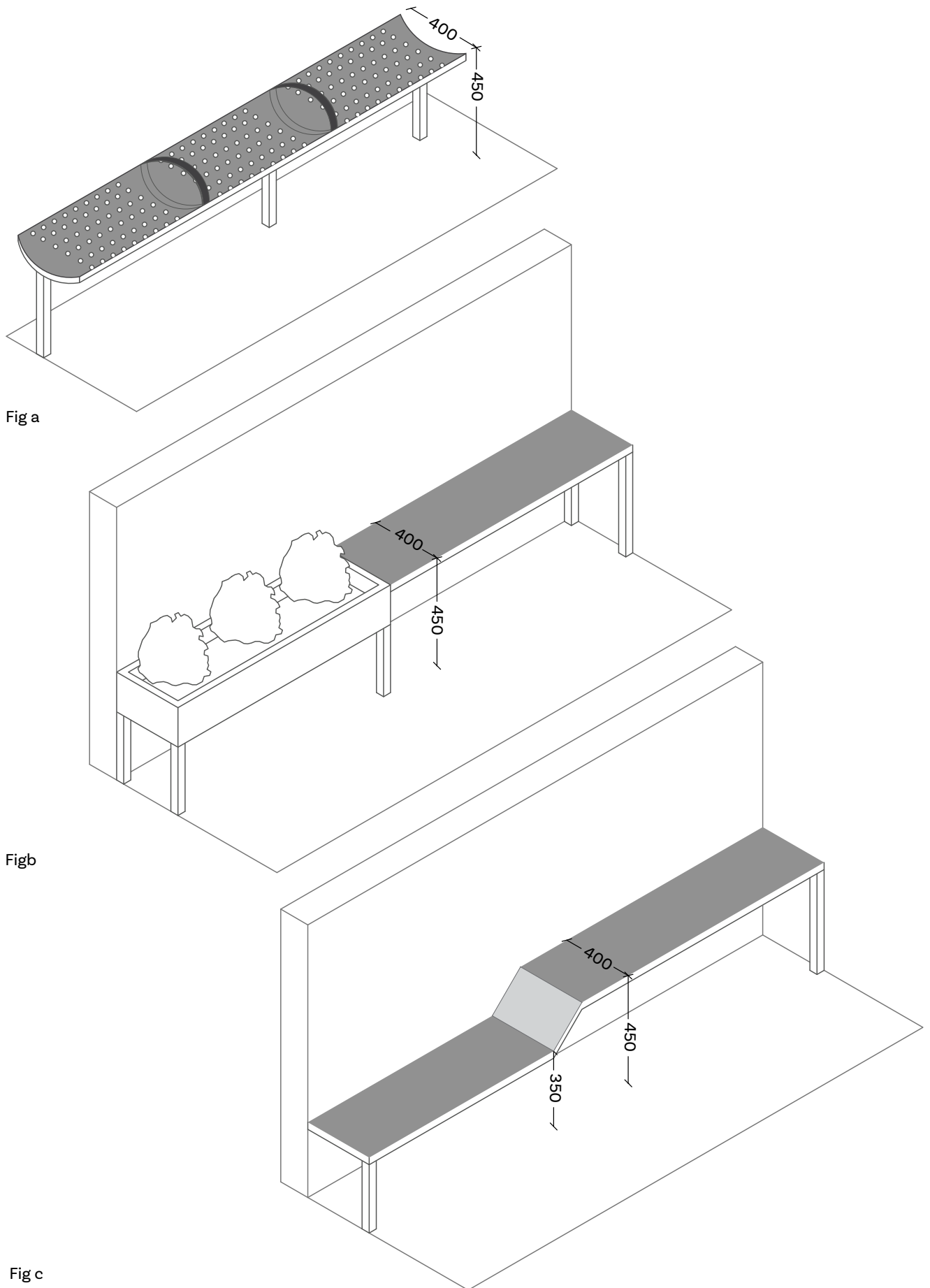


Fig a

Fig b

Fig c

Figure 3.29 Accessible seating typologies: 3d visualization Type B





Image 3.27 Seating with external landscapes  
Photo Credits: Dr. Gaurav Raheja



### 3.14.2 Bollards

1. Bollards are used as guiding and preventive elements to segregate and avoid vehicles climbing on pedestrian spaces.
2. They need to be positioned carefully through proper planning and understanding to ensure that they don't pose as barriers to wheelchair users, ambulant disabled, parents with strollers, elderly and several other kinds of user categories.
3. Bollards should not be positioned within an access route and should be identifiable by using contrasting colours, reflective bands or materials around the neck.
4. It is recommended to have bollards

with a minimum height of 800 mm and placed with adequate spacing between them ensuring a minimum of 900 mm clear passage width for wheelchair users and others including baby prams. (Refer Fig: 3.30)

5. Linking bollards with ropes or chains shall be avoided as this can present a hazard to people with visual impairments.
6. Bollards as street elements should be checked for regular maintenance and acts of vandalism.

### 3.14.3 Litter Bins and Trash Cans

1. Placing litter bins and trash cans on streets or in public spaces or neighborhoods should be done by

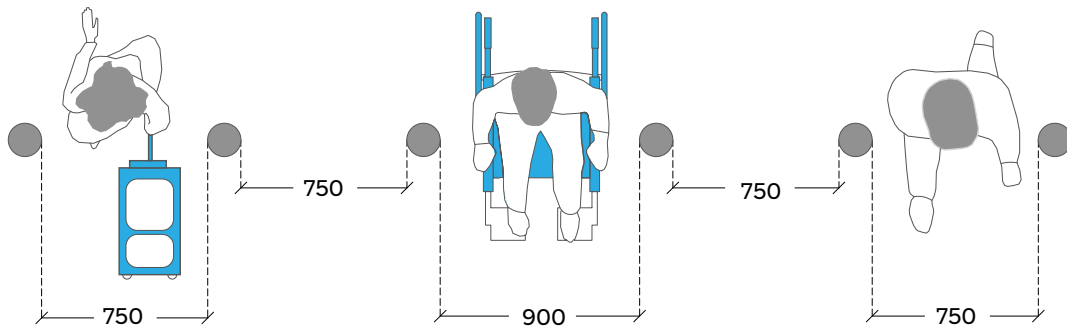


Fig a: Plan

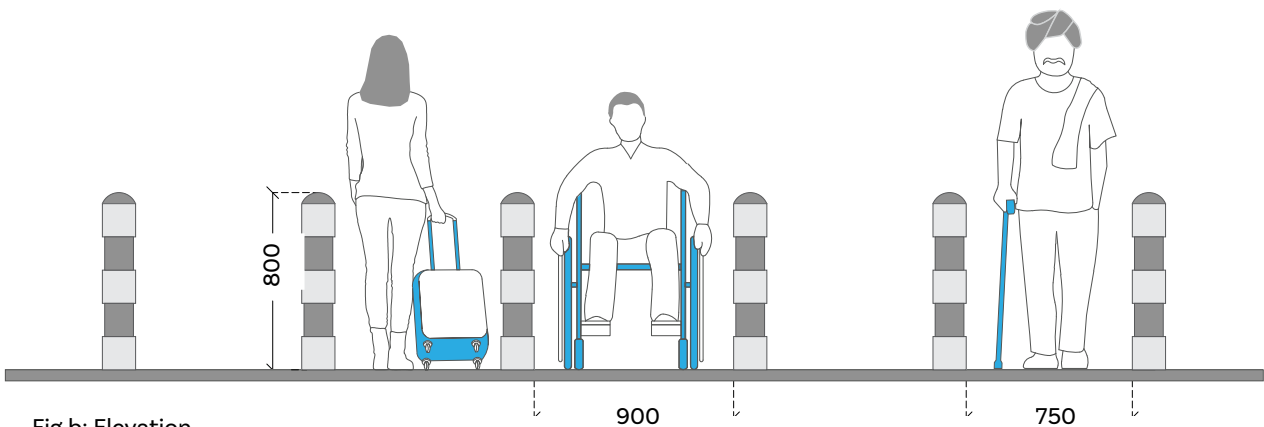


Fig b: Elevation

Figure 3.30 Bollard Details



Image 3.28 Typical bollard placement for accessible sidewalk with tactile pavers: Church Street  
Photo Credits: Shreya Shetty



understanding the ease of access and points of convenience. Designs of litter bins should ensure safety from stray animals as potential hazards to users in external spaces.

2. It would be apt to consider the local conditions of the place, the climatic environments and service mechanisms of regular cleaning for maintenance staff as well.
3. An apron space around free standing or fixed litter bins is recommended to ensure hygienic conditions.

#### **3.14.4 Protruding Objects**

1. It needs to be ensured that the various furniture are aligned in a synchronous manner without obstructing the clear access routes. Refer Fig: 3.31 and 3.32
2. Hazard protection should be provided if objects project more than 100 mm into an access route and their lower edge is more than 300 mm above the ground. This could be in the form of overhead protrusions of tree branches or extended elements in walking zone, unmaintained surfaces, lack of visually contrasting elements, etc.
3. Protruding objects, if any, must not reduce the clear width of the passage required for an access route or manoeuvring space.
4. If well designed and installed, each element plays a vital role in enhancing accessibility of an external environment. Following accessibility provisions need to be considered while designing or placing street furniture elements in diverse urban contexts.

#### **3.14.5 Miscellaneous**

1. Several other elements like electricity junction boxes, lamp posts, electric poles, telephone booths, wayfinding signage etc. need to ensure a well coordinated location in an external environment.
2. Elements such as free-standing posts and columns should be highlighted by means of a 150mm-high feature, such as a crest or band, positioned 1500mm above ground level, which visually contrasts with the furniture itself.
3. All external elements or street furniture should be visually contrasting with the background, ensuring distinct visibility and legibility.
4. In times of repair or maintenance of any street furniture, it is recommended to first create an alternate or temporary access route before initiating operations of maintenance.

#### **3.15 External Landscapes**

Landscape features as part of external environments play a vital role in enhancing universal accessibility of the built environment. The landscape materials of a site include ground covers, shrubs, trees and other elements of vegetation besides hard paved surfaces, water as an element and other built features of a landscape.

Appropriately chosen landscape species in context of built environment can enhance sensory features of the built environment and may aid as landmarks for persons with sensory impairment, esp. Vision impairments. Well designed landscapes may provide soothing and relaxing environments to all while enhancing comfort for the ones with cognitive impairments or mental health issues.

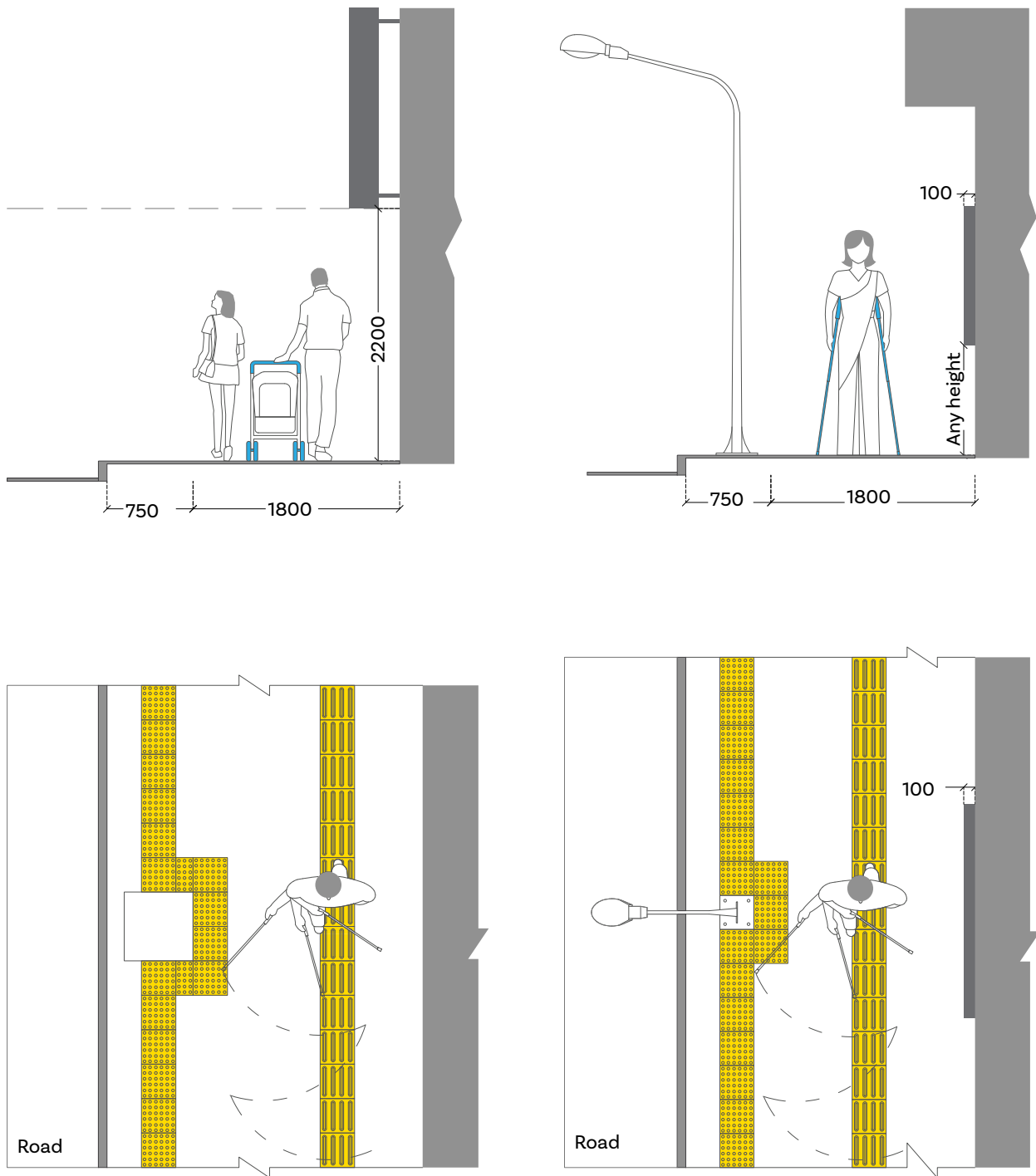


Figure 3.31 Street obstruction: Typical detail type A & B

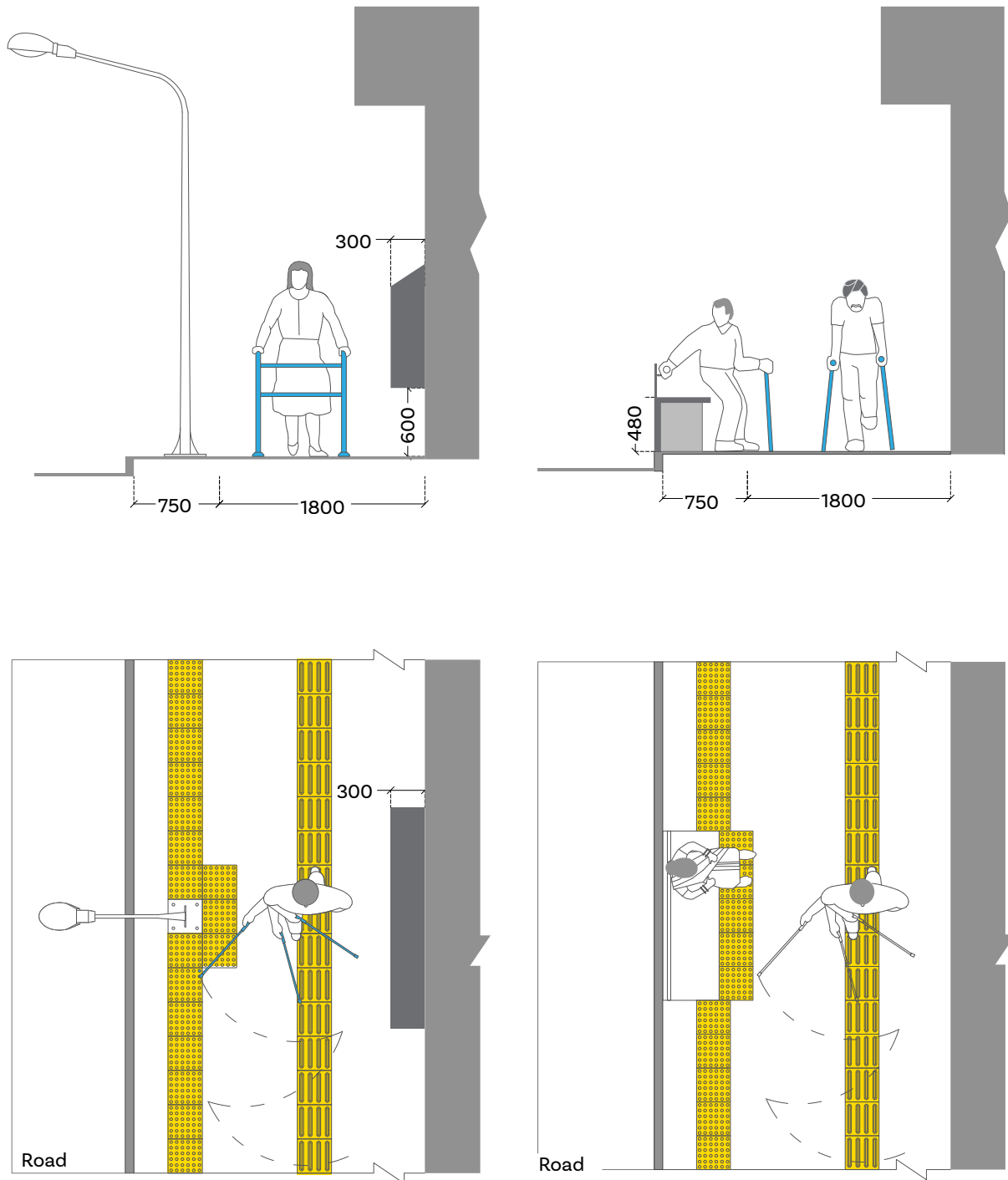


Figure 3.32 Street obstruction: Typical detail type C & D



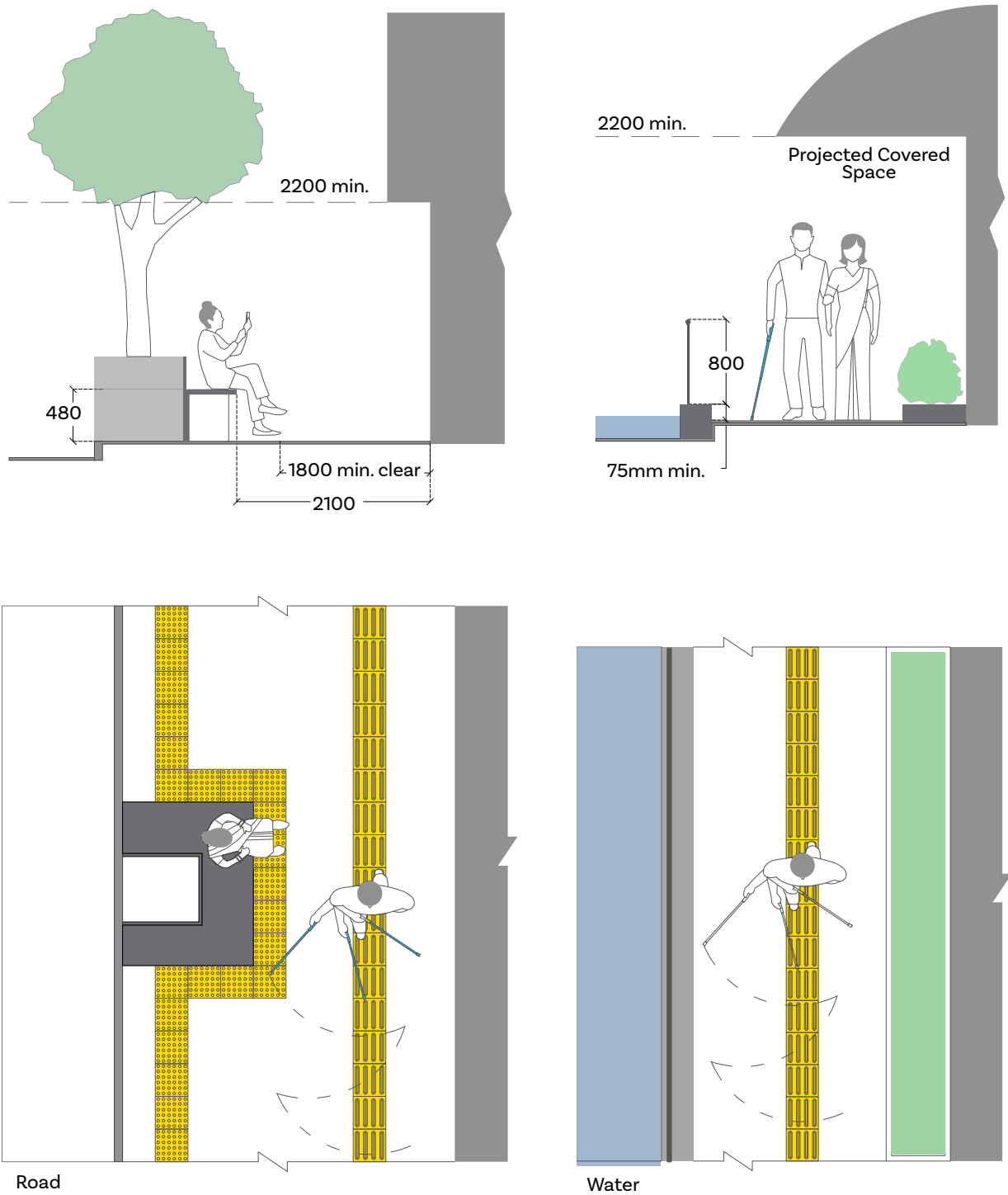


Figure 3.33 Street obstruction: Typical detail type E & F

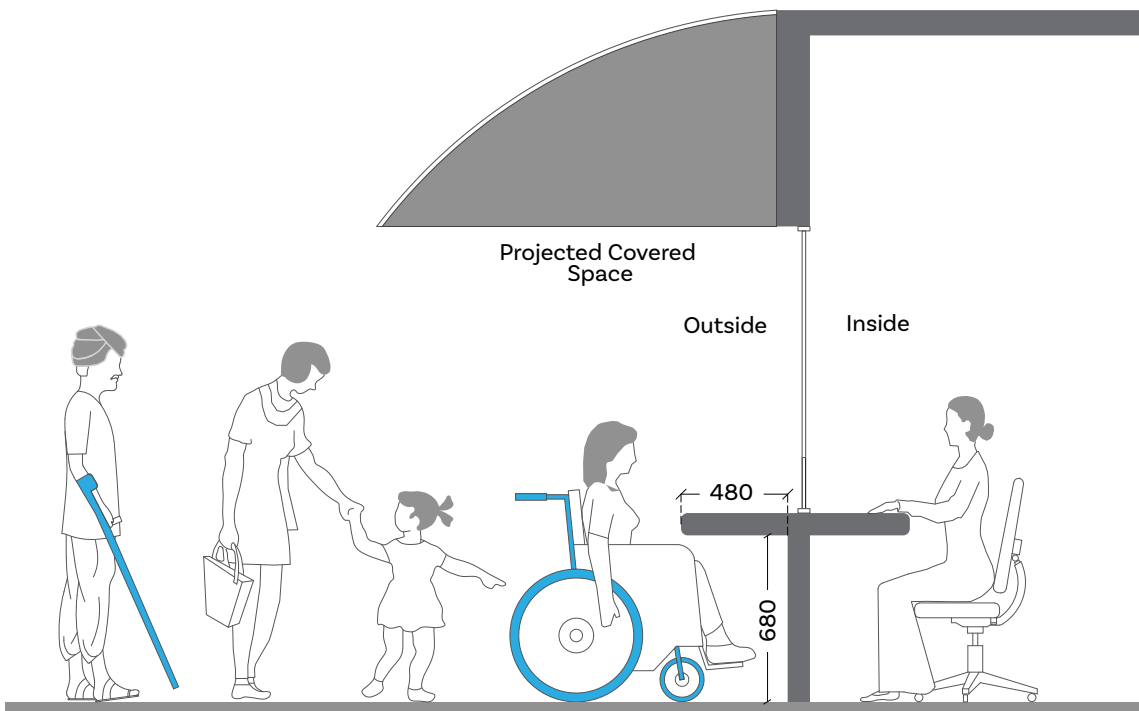


Fig a: Section

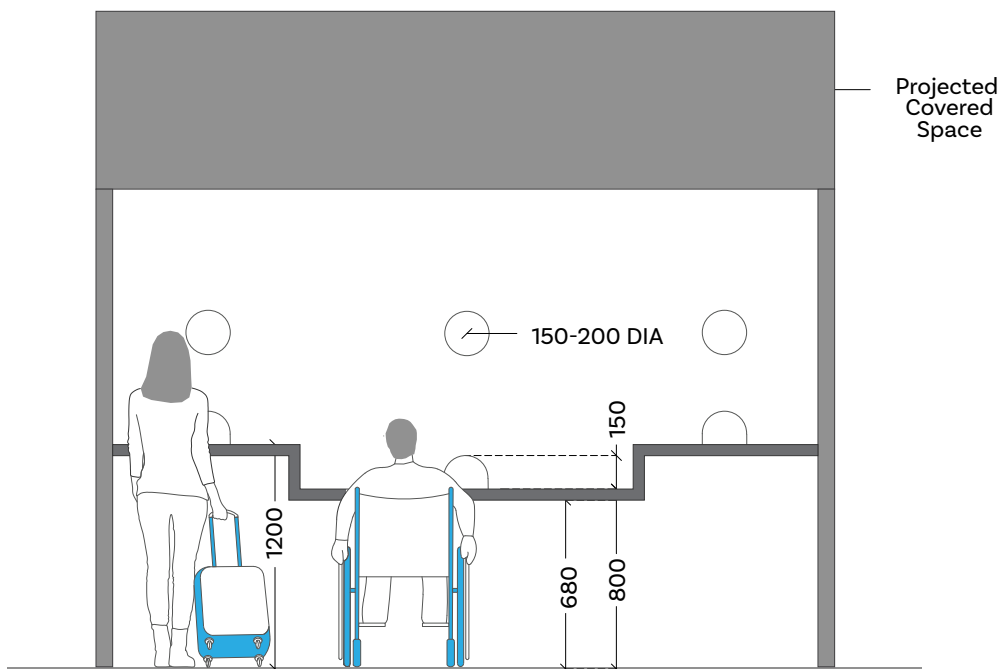


Fig b: Elevation

Figure 3.34 Typical ticket counter details showing accessible heights



Image 3.29 Ticket counters  
Photo Credits: DMRC, New Delhi



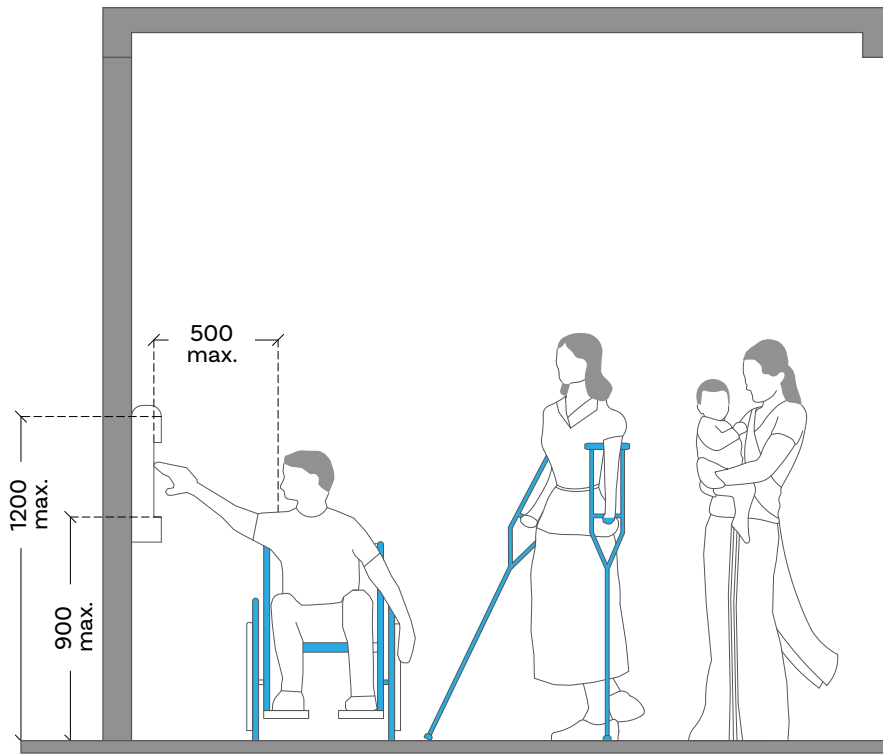


Figure 3.35 Vending machine

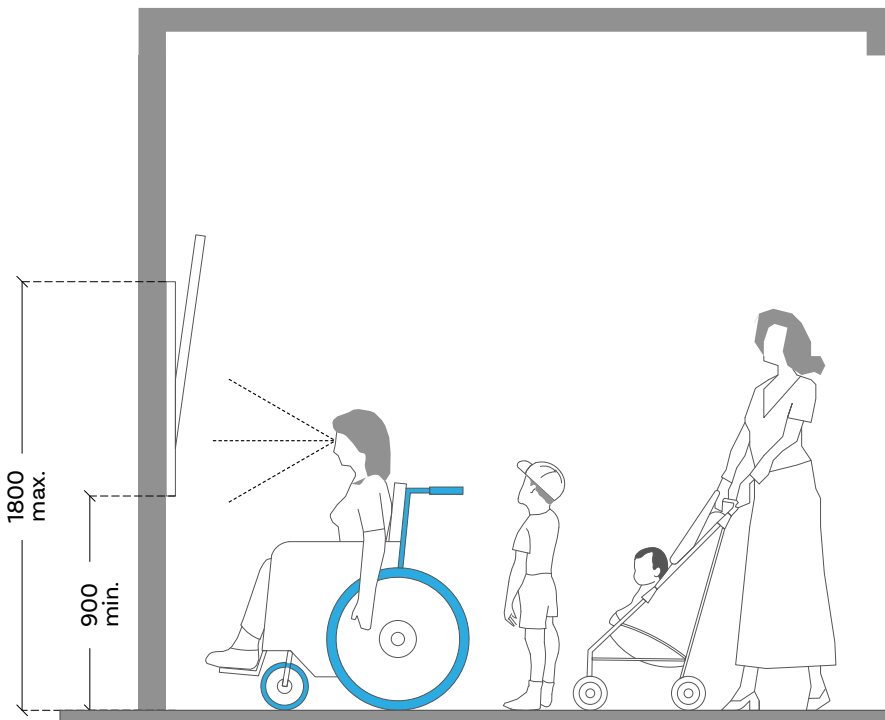


Figure 3.36 Information display board

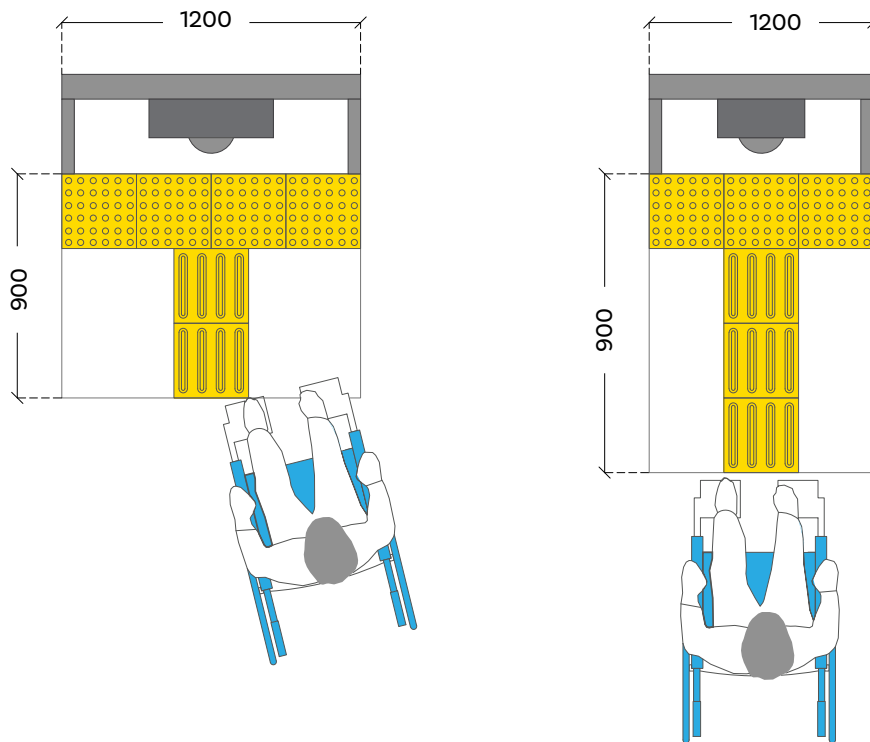
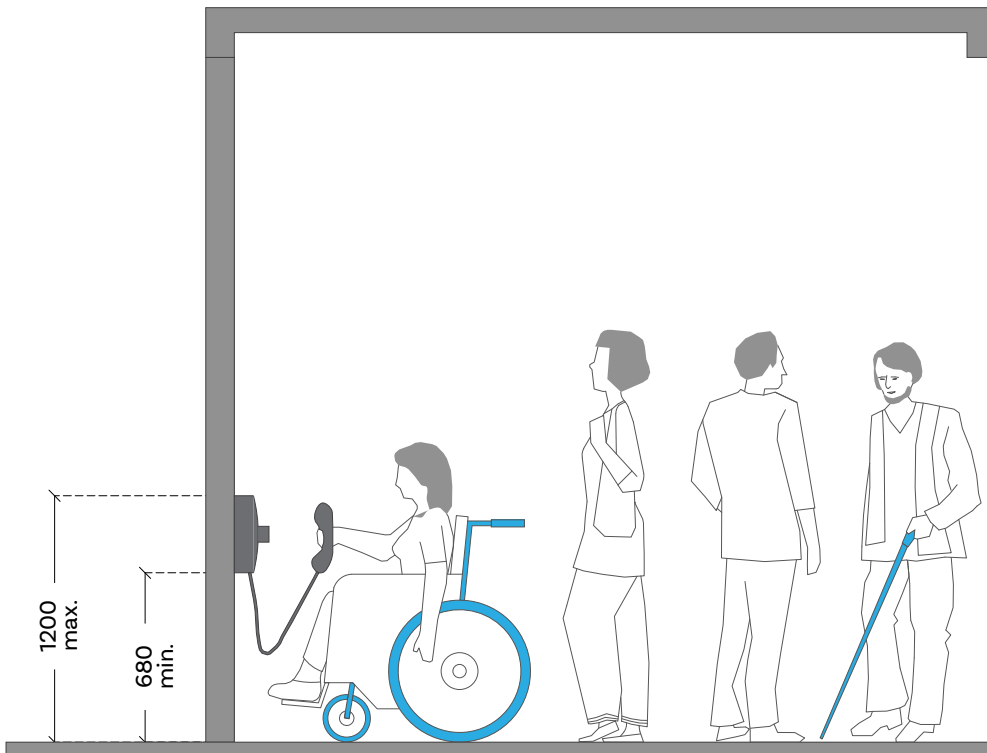


Figure 3.37 Outdoor phone unit





Image 3.30 Outdoor telephone unit  
Photo Credits: Dr. Gaurav Raheja



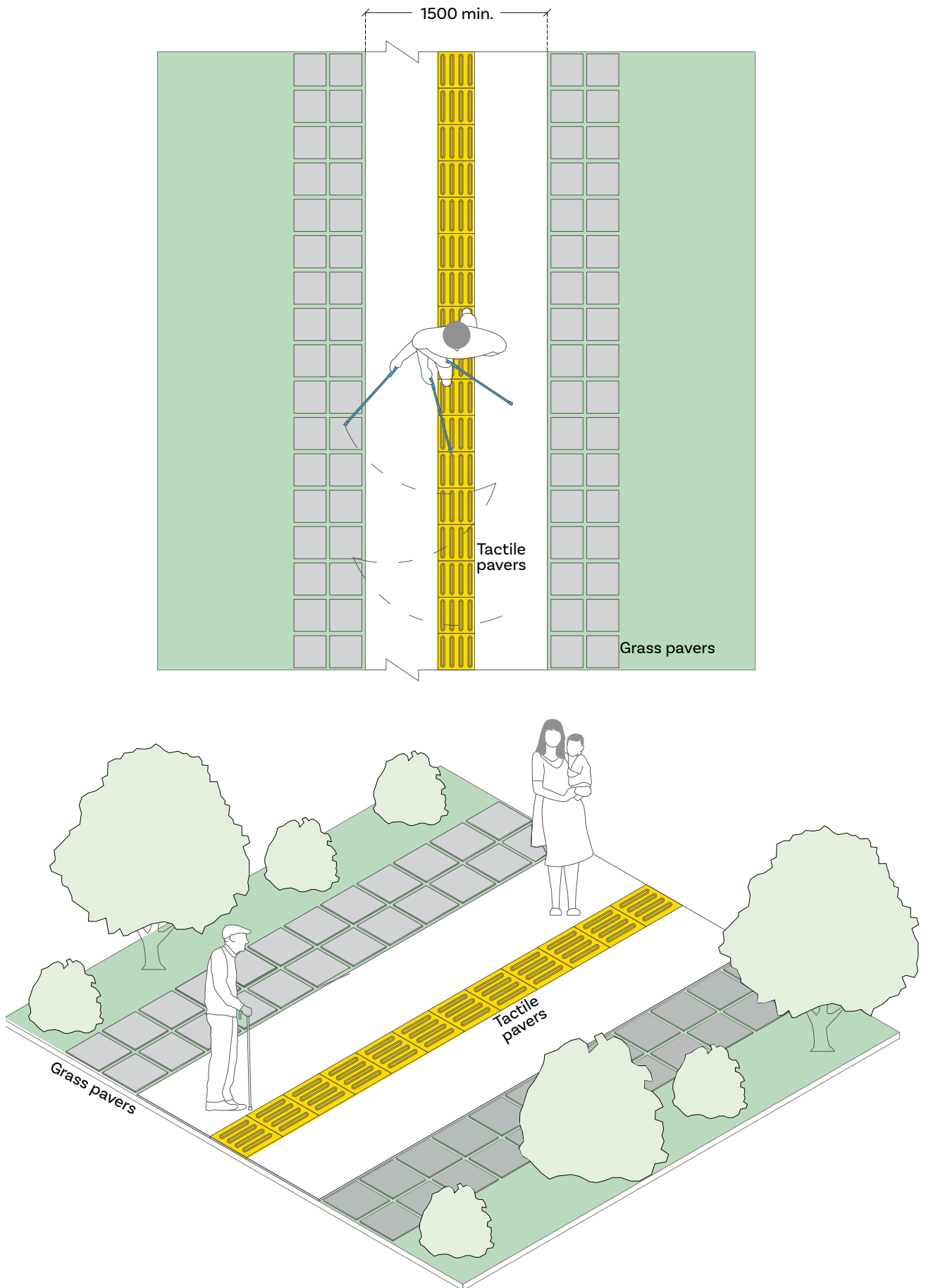


Figure 3.38 Accessible paved pathways with grass pavers





Image 3.31 Accessible external landscape with tactile pathways  
Photo Credits: Dr. Gaurav Raheja



### Chapter 3: External Elements

Role of water needs to be appropriately explored as a sensory element while ensuring no threat to safety of persons with disabilities and others. On the other hand water collection on street edges or at kerb ramp edge poses threat to diverse user groups esp. Elderly, ambulant disabled, etc. Water drainage should be well planned in the landscape zones of built environment.

Tree or shrub branches in landscaped walkways pose as potential barriers to all, esp. persons with vision impairments. It

is important to therefore ensure proper maintenance of landscape areas through proper training and sensitisation of landscape workers and professionals.

Landscapes include provision of built features like open air theatres, etc. which could be developed as accessible spaces using gradual slopes with earth mounds or ramped slopes, etc.

Plazas, walkways or other typologies of built environment spaces in large campuses must sensitively respond



Image 3.32 Street Pavers  
Photo Credit: Dr. Gaurav Raheja



to the needs of diverse user groups. Materials like grass pavers in sandstone or kota stone, etc. may be designed in such a way that a clear hard paved length with a min. 1200 mm clear is available to users with footwear with heels or stick or cane users, etc.

Adequate lighting provisions be made in the external landscapes such as to minimise the effect of shadows on surface visibility. If not addressed, this may pose mobility challenges to persons with low vision.

Growing herbs or plantations with utilitarian value as an embedded aspect of Indian culture may transform landscapes as spaces of cultural inclusion as well besides being accessible to attributes of age, gender and abilities.

Outdoor landscapes need to integrate inclusive play areas and rehabilitation spaces to ensure inclusion of children with special needs, persons with disabilities and others who at any phase of life could require to use such features of outdoor landscapes with accessibility. It is important to continuously evolve



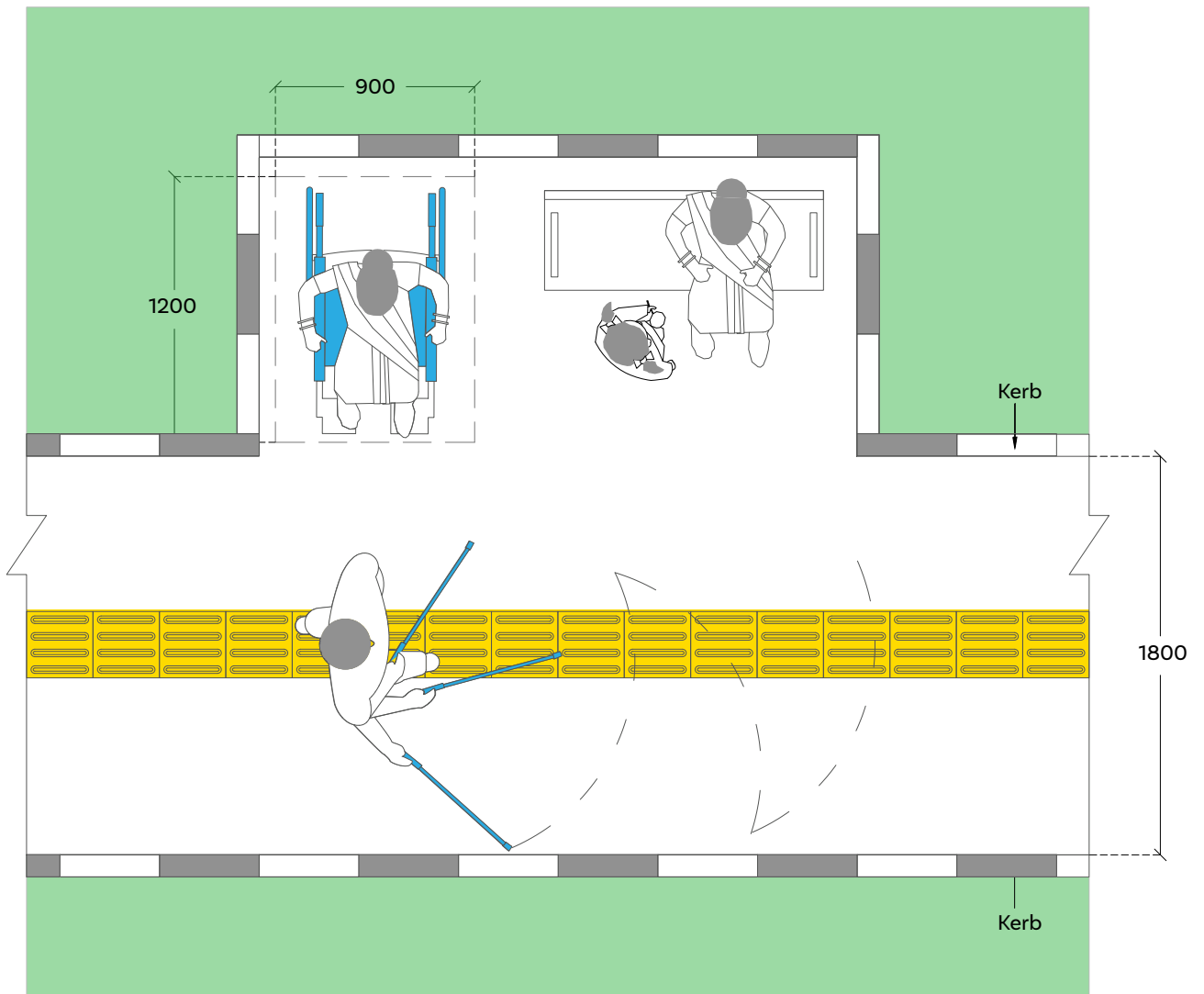


Figure 3.39 Dimension and space requirement for seating in parks and green spaces

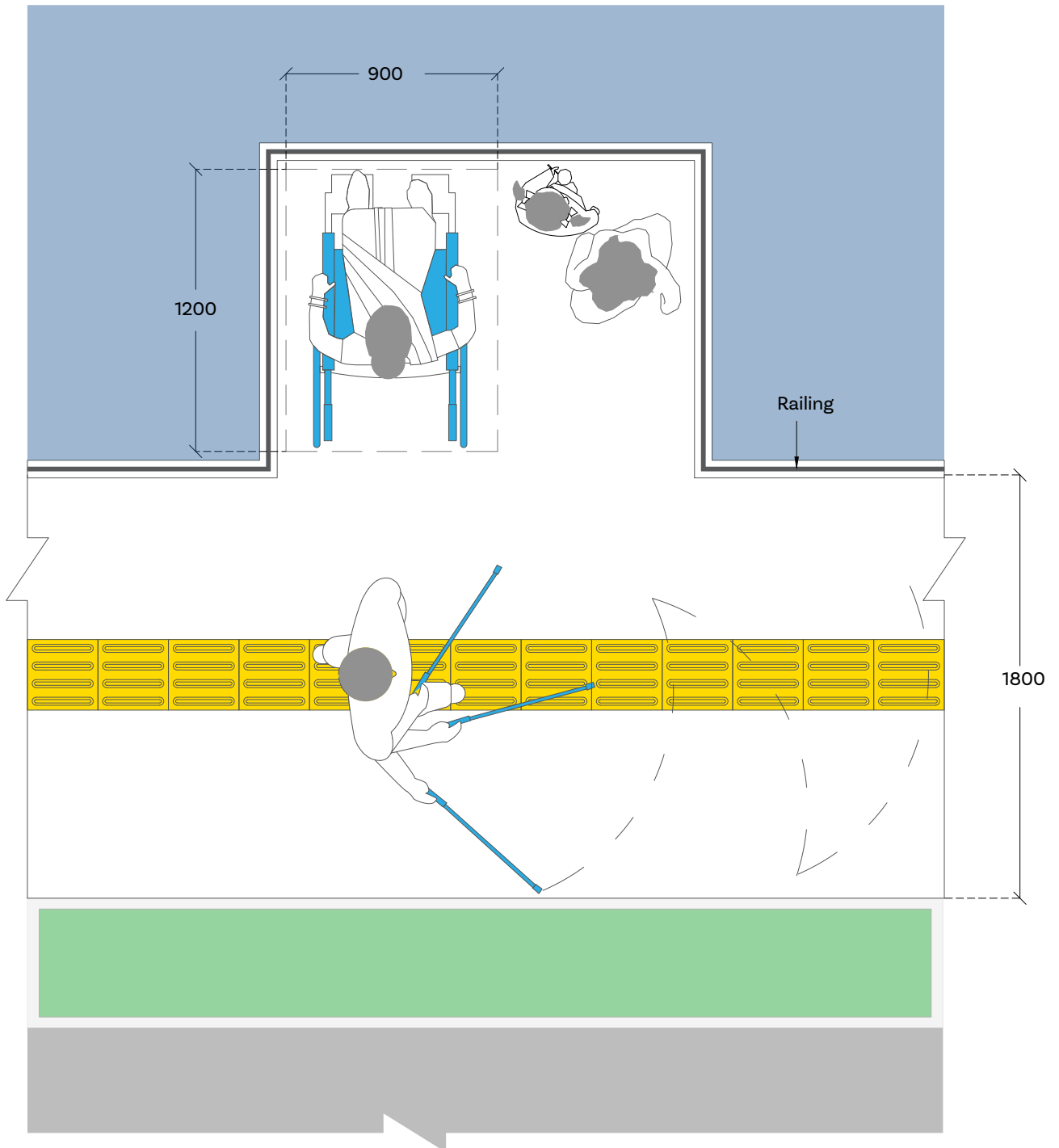
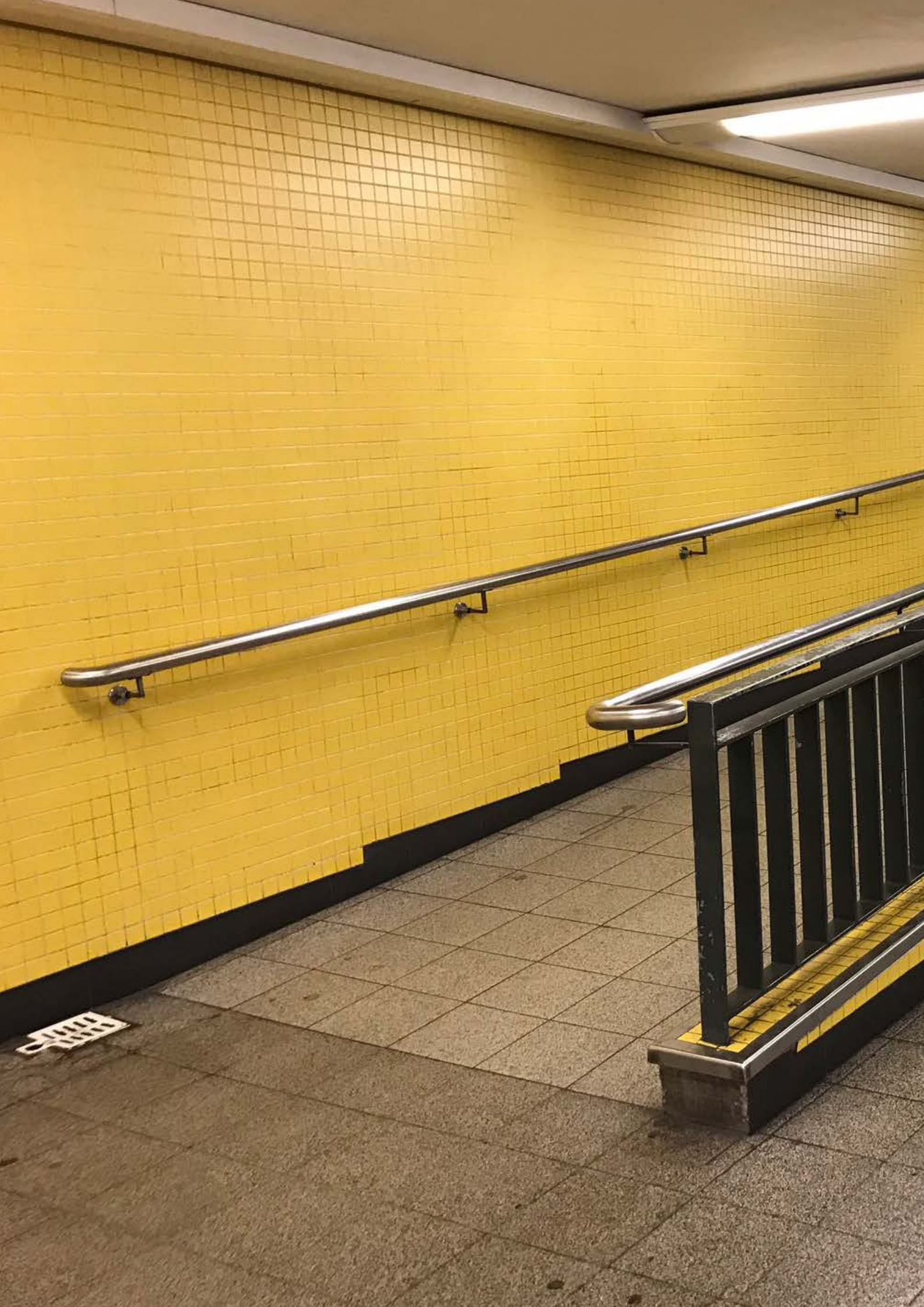


Figure 3.40 Dimension and space requirement for water edge/ waterfront seating





EXIT









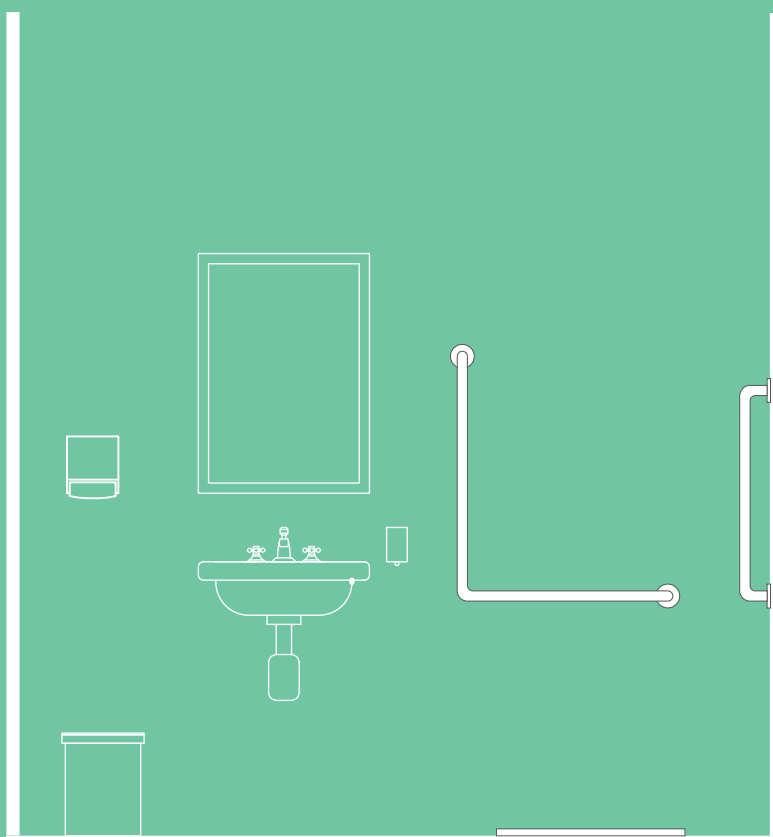




*The resilience and fortitude of persons with disabilities inspires us. Under the Accessible India initiative, numerous measures have been taken that ensure there is a positive change in the lives of our Divyang sisters and brothers.*

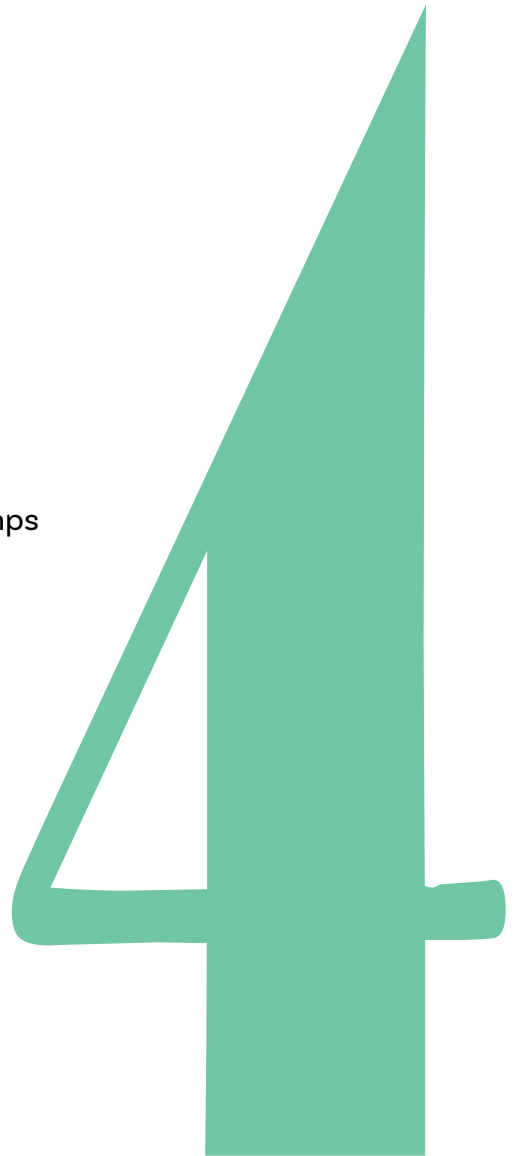
**Shri Narendra Modi**  
**Prime Minister, India**

Twitter Post by @narendramodi, 3 Dec 2020,  
Address on International Day of Persons with Disabilities



# Internal Elements

- 4.1 Building Entrances
- 4.2 Waiting Areas
- 4.3 Reception Counters & Spaces
- 4.4 Horizontal Circulation - Corridors
- 4.5 Vertical Circulation - Staircase
- 4.6 Vertical Circulation - Internal Ramps
- 4.7 Elevators, Lifts & Escalators
- 4.8 Internal Drinking Water Facilities
- 4.9 Internal Sanitary Provisions
- 4.10 Internal Doors and Fixtures
- 4.11 Windows
- 4.12 Guest Rooms
- 4.13 Eating Spaces
- 4.14 Wardrobes and Storage Shelves
- 4.15 Controls (Electrical, Mechanical & Others)

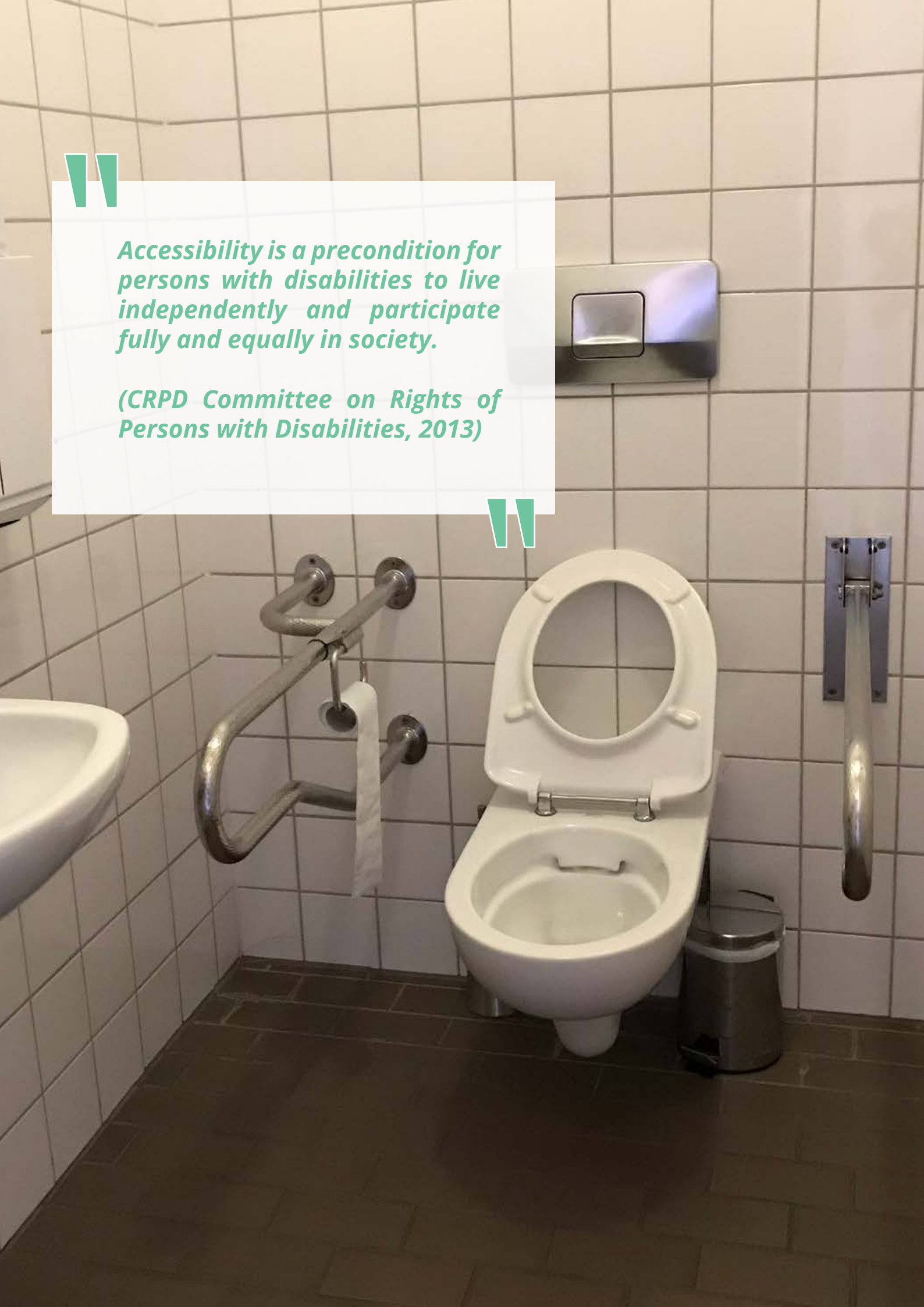






*Accessibility is a precondition for persons with disabilities to live independently and participate fully and equally in society.*

*(CRPD Committee on Rights of Persons with Disabilities, 2013)*



## 4

## INTERNAL ELEMENTS

A fully functional building is an integrated outcome of its envelope design, its configuration of internal spaces with allied services to support the intended functions with convenience, access, safety and dignity. It is important to therefore appreciate the role of each internal element of a building and its careful design, material choice, installation and overall management and maintenance to ensure accessibility and safety for all. Absence of information or wayfinding systems, a steep ramp slope or a faulty detail, a missing handrail, a high door knob, absence of manoeuvring space for wheelchairs or baby prams, etc. can all cause challenging experiences and pose as barriers to majority including persons with disabilities and several others with limited functional abilities.

Internal elements of our built environments require to compliment the external elements to ensure a universally accessible experience for all. This implies sensitive ways of designing buildings and their interiors with adequate care and assurance of accessibility provisions at the highest levels. Every building typology and its intended usage must exert to widen the scope to accommodate diversity of users through an understanding of accessibility requirements for each internal element. It is relevant to be mindful of the needs of persons with disabilities, elderly, women, children and other fast changing

social and technological contexts. Use of various building technologies like stairlifts, platform lifts, audio alarms, beepers, digital signage, etc. This chapter further sheds light on accessibility standards, guidelines and implications for a range of internal elements in diverse building typologies.

#### 4.1 Building Entrances

The building entrance includes all access and entry points into a facility. An accessible building entrance needs to consider several elements like a designated approach, passenger alighting and drop off points, pedestrian access and other allied services at entrance in diverse building typologies. The main entrance of any building must ensure access for all including persons with disabilities, elderly and others with special needs without a need for special entry.

##### 4.1.1 Approach to Building

1. A passenger alighting and boarding point should be provided at the level of approach for Persons with Disabilities or others with special needs to alight from and board a vehicle.
2. Where transfers have to be made from a vehicular surface to a

pedestrian surface, the driveway and the pavement or footpath surfaces should be blended to a common level or ramped.

3. Difference in levels between driveways and footpaths surface should be avoided. Where the difference is unavoidable, such drop shall have a kerb ramp in compliance with Section 3.7.
4. Building entrances should be covered through a porch, canopy or any other measure to ensure a convenient and accessible entrance experience in unpleasant weather conditions as well.
5. Planters or other landscape elements around the building entrance should be kept in a way that it does not cause any barrier to hold grab rail support or in the path of movement. However, they can be well integrated to enhance sensory features of accessibility.

#### **4.1.2 Passenger alighting and boarding points**

A passenger alighting and boarding point should:

1. Provide an access aisle of at least 1500mm wide by 6000mm long adjacent and parallel to the vehicle pull-up space;
2. The accessible aisle must be at the same level as the vehicle.
3. Have a kerb ramp complying with Section 3.7, if there are kerbs between the access aisle and the vehicle pull-up space;
4. Wherever possible, be sheltered and have identification signage (symbol of accessibility) for alighting area.
5. Tactile floor guidance be provided from the building drop off area leading up to the entrance of the building.

#### **4.1.3 Access to Building**

1. There shall be a common accessible entrance for everyone which follows the principles of universal design.
2. The access must be through the main entrance of the building.
3. An access route should be provided connecting all major entrances & exits of the building from the alighting and boarding point of taxi stands and car park lots for Persons with Disabilities.
4. Wherever possible, entrances should be made step free to enhance accessibility for all. In case they are on a raised plinth, they should be complemented with steps and ramps serving choice of entrance. Both the ramps and steps must have adequate landing space for wheelchair manoeuvring, handrails for support, tactile guiding systems to the entrance and other aspects to ensure convenience and safety..
5. Steps to entrance must ensure adequate visual contrast within the treads and risers alongwith handrails for support.
6. In existing buildings or heritage buildings, provisions of stairlifts or other accessible technologies should be explored to enhance accessibility at the entrances.
7. For buildings requiring entrance through security panels like in hotels, shopping malls or other public buildings, it is ensured that the security panels are accessible to persons using wheelchairs, elderly, baby prams or others with special aids for functional use.
8. In multi storey buildings, the accessible entrances must have an accessible route leading to the elevators.
9. The accessible entrance, if different from the main entrance, should be





**Image 4.1** Access to building  
*Photo Credits: Dr. Gaurav Raheja*

located adjacent to the main entrance and not at the rear of the building. The accessible entrance should be clearly signed and easy to locate.

10. Directional signs bearing the symbol of access must be displayed at all other non-accessible entrances to direct persons with disabilities to the accessible entrance.
11. Adequate signage system enables persons with hearing impairments and majority users access the entrance to buildings independently.
12. Access to entrances must be free from barriers of any kind. Further, planters or other accessories used to enhance the entrance experience be kept clear from the access route at all times.

#### **4.1.4 Accessible Entrance Doors and Spaces**

1. The building should have all accessible entrance doors served by an approach complying with Section 4.10.
2. The clear width of the accessible entrance door should not be less than 900mm. However, it would be preferable to have 1000 mm or more for most cases especially buildings open to public.
3. The width of the corridors or passageways leading to and from such access door should not be less than 1200mm.
4. A clear, firm and level landing of at least 1800mm x 1800mm should be provided on either side of the entrance door.

5. Internal floor surfaces should be anti-skid/ non-slip and of materials that do not impede the movement of wheelchairs/other mobility aids.
6. If a mat is provided it should be flushed with the floor finish. Persons with visual impairments find it easier to locate doors if there is a texture difference in the floor around the doorway from the rest of the flooring. It is generally a good practice to recess foot mats in the floor on either side of the door but care must be taken to ensure that the top end of the mats are flush with the rest of the flooring.
7. In addition to tactile pavers leading to the main entrances, beepers may be put at all main entrances to enable people with visual impairments to locate them.
8. A tactile layout plan of the building along with Braille and audio systems should be provided at the entrance for persons with visual impairments.
9. Glazed entrance doors must have manifestations on the glass preferably at two levels i.e. one between 800 to 1000mm and another between 1400 to 1600mm above the floor.
10. The manifestation should be contrasting in colour from the immediate background and be minimally 150mm high.

#### **4.1.5 Access Control Barriers**

1. In several buildings like transportation terminals, library buildings, etc. access control barriers along with automated fare collection systems are integrated to regulate entry. In such cases of installation, it is recommended to ensure that at least one of the access control barriers is minimum 900 mm wide ensuring access to wheelchair users, baby strollers or others with special needs.

2. Turnstiles are not recommended for access control. In unavoidable situations, they must be supported with an alternate access route with swing gates of minimum clear width 900 mm for access to persons with disabilities.

## **4.2 Waiting Areas and Seating Spaces**

Waiting areas or spaces need to be contextually planned for various building typologies. As a generic recommendation they should be easily locatable, identifiable and usable by diverse user groups in many different contexts of built environments. For eg. waiting spaces in public buildings or in transportation hubs shall all require to adhere to specific norms of those building typologies keeping in view the needs of persons with disabilities and other diversity. Waiting spaces could be planned for short or long duration keeping the inclusion of diversity in mind. Following recommendations are being made for developing accessible and inclusive waiting spaces :

1. Waiting areas in buildings should be inviting and provide a supportive and a convenient experience of their use by all in diverse building typologies. This may include public offices, banks, transportation hubs, healthcare buildings, educational environments, shopping malls, cinema, etc.
2. Waiting spaces need to be conveniently located to provide ease in access to reception desks, entrance/exits, service areas or other public utilities or functions ensuring least effort for persons with disabilities and others to reach to the service from their seating position.
3. Waiting spaces shall provide accessible seating with priority signage for persons with disabilities,





Image 4.2 Accessible waiting area  
Photo Credits: Dr. Gaurav Raheja



Image 4.3 Accessible seating spaces  
Photo Credits: Dr. Gaurav Raheja



elderly and others with functional limitations or special needs. In contexts of public buildings like public offices, banks, hospitals, transportation terminals or systems, etc., waiting areas must have provisions for priority seating to accommodate persons with disabilities, elderly and others with functional limitations or special needs.

4. While most waiting areas remain open to public, it is recommended to designate few waiting spaces in buildings as quiet areas or silent zones as waiting spaces for persons with persons with neuro diverse conditions, feeding mothers or others..

5. Seating design needs to adopt a configuration and layout ensuring clear aisle width of 900 mm or more to ensure manoeuvring spaces and ease in movement for wheelchair users, ambulant disabled, baby strollers, rollators, etc.
6. Seating space, such as those provided at counters, tables, or work surfaces for persons in wheelchairs should have a clear and level floor space of not less than 900 mm x 1200 mm. Refer (Fig: 4.1)
7. For comfort, seat height is recommended to be between 450 mm-500 mm and seat depth to be between 400 mm to 450 mm.
8. Seat backrest should be at an angle of

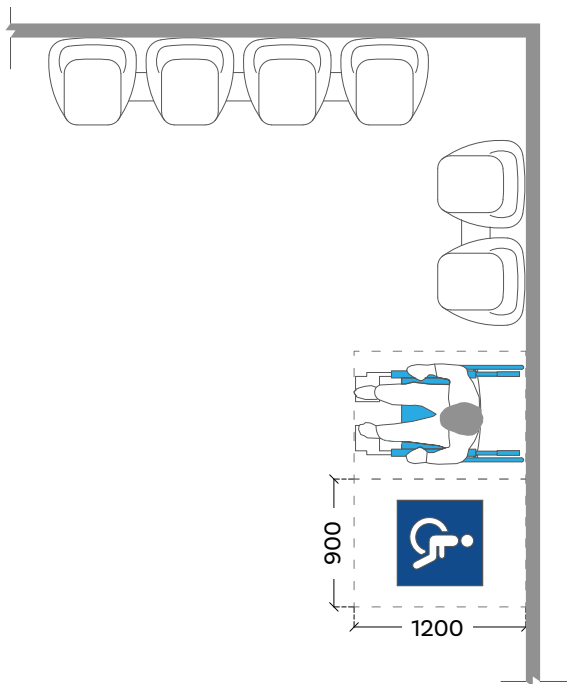


Fig a. Type A

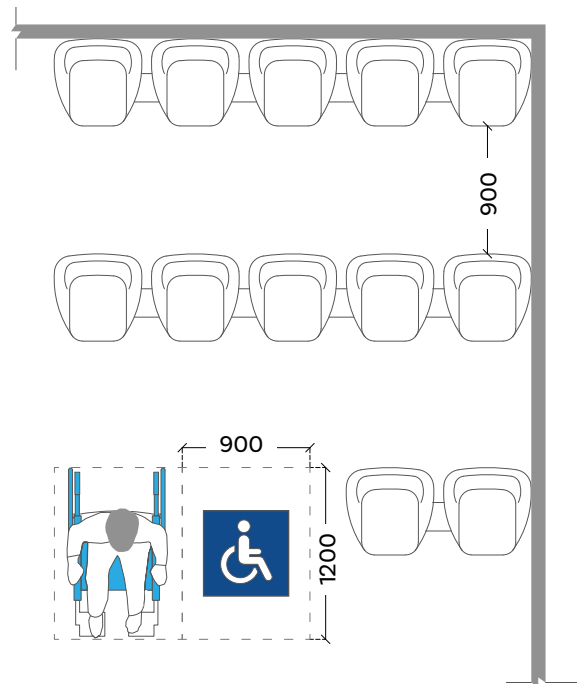


Fig b. Type B

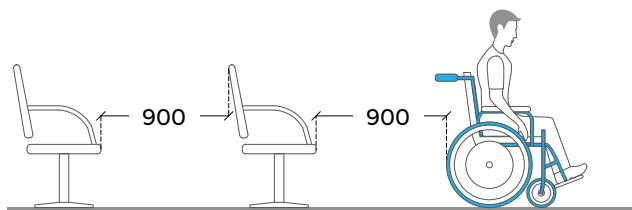


Fig c. Section

Figure 4.1 Typical configurations of waiting areas with reserved accessible seating

100° to 105° and armrests at a 700 mm height from the finished floor level. Seats with armrests and backrest to assist older persons and those with mobility difficulties with sitting down and standing up. However, few seatings in waiting areas may omit armrests to allow lateral transfer.

9. The height of the armrests should be between 220 mm to 300 mm above the seat and extend to the front of the seat.
10. Where a forward approach is used, a clear knee space of at least 900 mm wide, 480 mm deep and 680 mm high should be provided, which may overlap the clear floor space by a maximum of 480 mm.
11. Waiting spaces need to ensure adequate aisle space or widths of 900 mm in the waiting areas should have a provision for people with ambulant disabilities, wheelchairs, strollers, visually impaired and all others to safely move around.
12. Seating spaces for cinemas, theatres, concert halls, stadia or other places of public resort must have clearly identified wheelchair spaces, each measuring at least 900 mm wide by 1200 mm deep. Access to spaces for wheelchair users must be direct and unobstructed.
13. Given the diversity and dispersion of users, in environments of high footfalls and short term waiting, it is recommended to provide furniture with standing support along with seating spaces to accommodate diverse user needs.
14. Integration of Queue management systems using technology or alternative means are highly recommended to facilitate waiting space management and accessible services to diverse user groups.
15. It is recommended to provide

adequate consideration to acoustic design of waiting areas to ensure clear audibility from Public address systems. For an accessible audio announcement it is desirable to have sound levels with clear diction in a range of 50 dB or more. Appropriate treatment of all surfaces including structural and mechanical elements is desirable to achieve better acoustics in waiting spaces.

16. Uniform illumination of 200 lux along with adequate visual contrast is recommended for waiting spaces between seating, flooring and overall ambience of the environment.
17. Basic amenities like charging points, vending kiosks, etc. should be easily accessible from the waiting spaces, esp. in transportation, healthcare, education or other public space environments.

### **4.3 Reception Areas, Service or Information Counters**

Service or information counters in reception areas or otherwise need to provide access for all keeping in view the various special needs for persons with short heights (dwarfs), children, persons using wheelchairs or with sensory disabilities, elderly and all others. Following recommendations are being made :

1. Reception counters shall be well laid and located near the entrance and guided by adequate signage.
2. Tactile guiding indicators should guide persons with visual impairments to the reception counters in an unobstructed manner.
3. The counter shall be accessible to all. Therefore, it shall have two height ranges to accommodate diverse needs of users. The minimum height of the counter shall be in the range



Image 4.4 Accessible service and information Counter  
 Photo Credits: Dr. Gaurav Raheja

of 750 mm to 800 mm to facilitate wheelchair users or those with short height stature. However a counter height of 950 mm to 1100 mm is recommended, for persons using reception counters in standing postures.

4. Reception desks where writing is done by the visitor (for example at hotel receptions) should allow frontal approach by wheelchair users with space to provide clearance for wheelchair user's knees.
5. Reception counters may be provided keeping in view a person using wheelchair on either side, thereby providing knee clearance space of 680 mm below the counter.
6. Where information displayed counters are provided, the bottom

edge of the counter must be at a height of between 700mm and 800mm from the floor and tilt at an angle which varies from 30° to 45°.

7. Hearing enhancement systems along with sign language support shall be provided at reception counters to cater to the needs of persons with hearing impairments.
8. It is desirable for receptions to make provisions for assistive devices and technologies like wheelchairs, hearing enhancement systems ( for example loop induction systems etc.), magnifiers, etc. alongwith human support to support the needs of persons with disabilities and others.
9. Important services like First Aid, defibrillators or other forms of emergency support may be provided



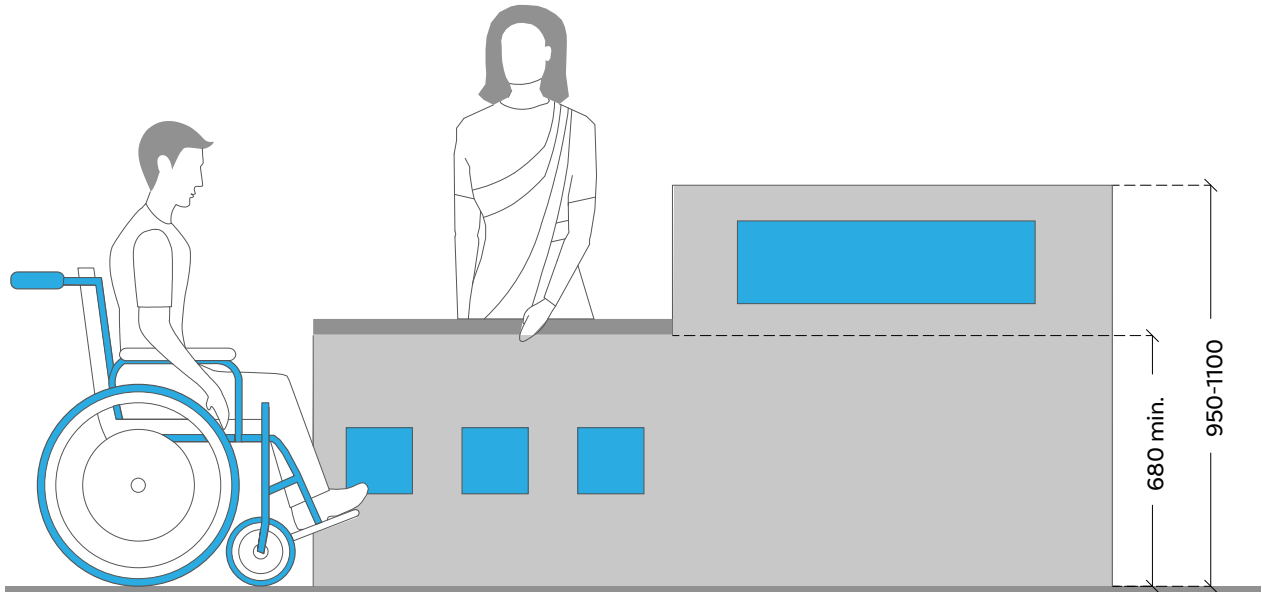


Figure 4.2 Reception counter with accessible heights

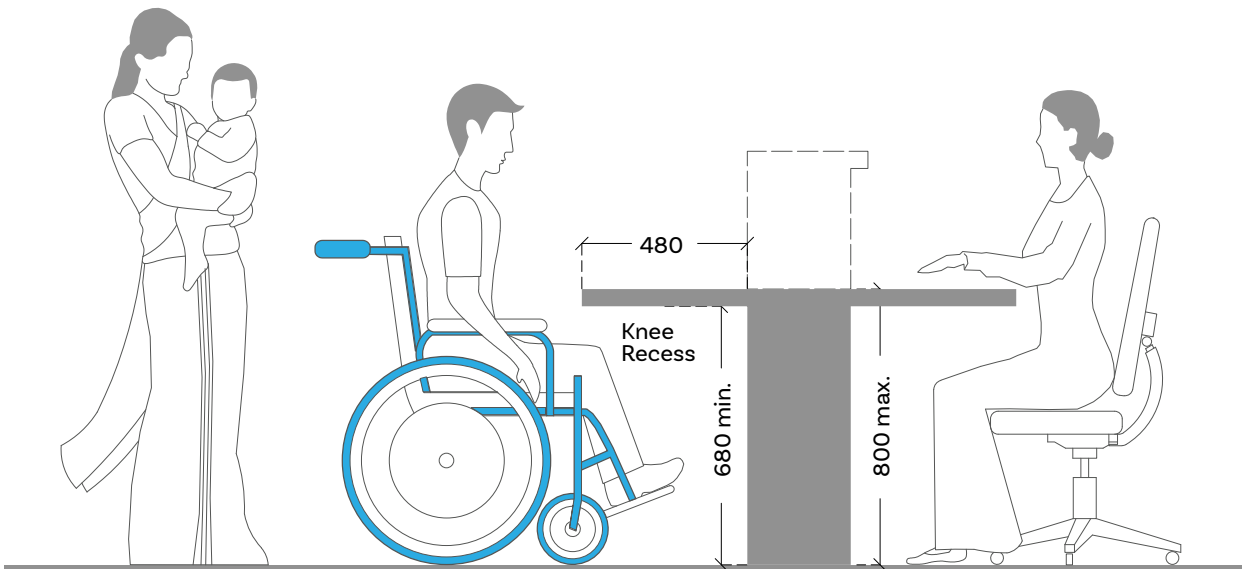


Figure 4.3 Accessible Service and Information Counters

on the reception through properly identified signage system.

10. As a good practice, reception counters shall indicate in a universally accessible way the icons or pictograms of various facilities available. It plays a vital role in informing people from a distance about the possible support available

at reception counters.

11. To facilitate lip reading, lighting should provide even illumination. The reading and writing surfaces at counters, desks and ticket offices shall be illuminated to a level of at least 200 lux in the room, and on the desk in a range of 350 lux to 450 lux.

12. It is important to ensure that reception staff is trained in supporting the special needs for diverse user groups. This may include elements like knowledge of multiple languages including sign language, technology support for guiding assistance, etc.

### Routes

Design for movement spaces and circulation within any building are recommended to provide clear, obstruction free passages for all including persons with disabilities and others in accordance with the mobility traffic of the building typology. While designing internal corridors as horizontal circulation

### 4.4 Internal Corridors and Access

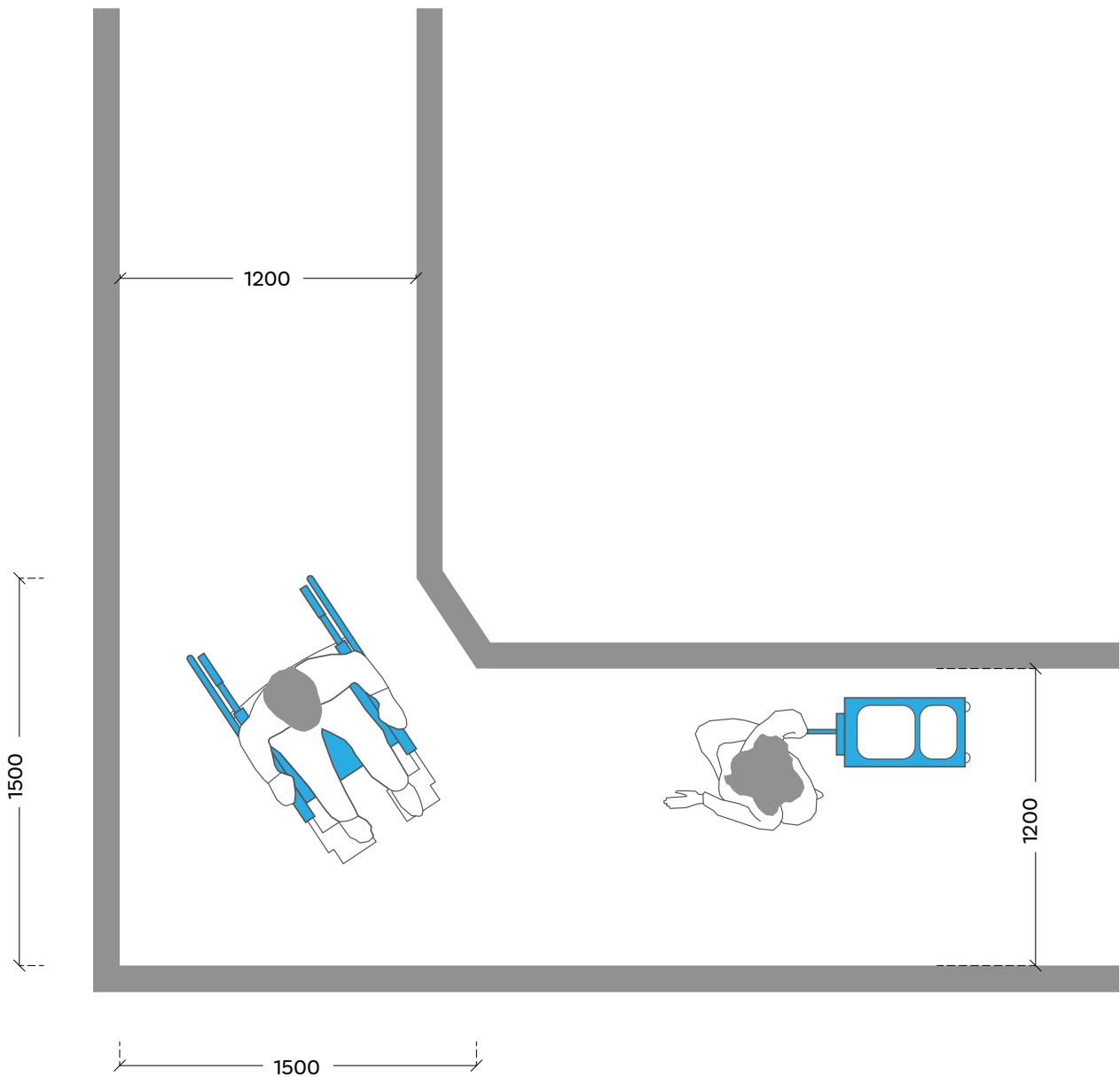


Figure 4.4 Dimension and space requirement for right-angled accessible corridor

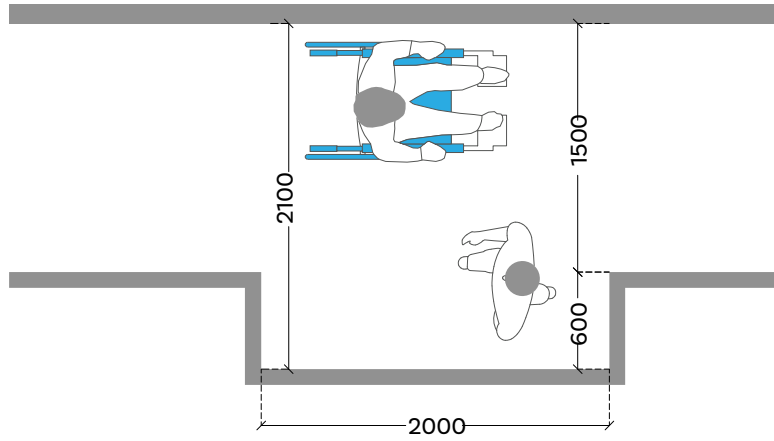


Figure 4.5 Dimension and space requirement for accessible corridor

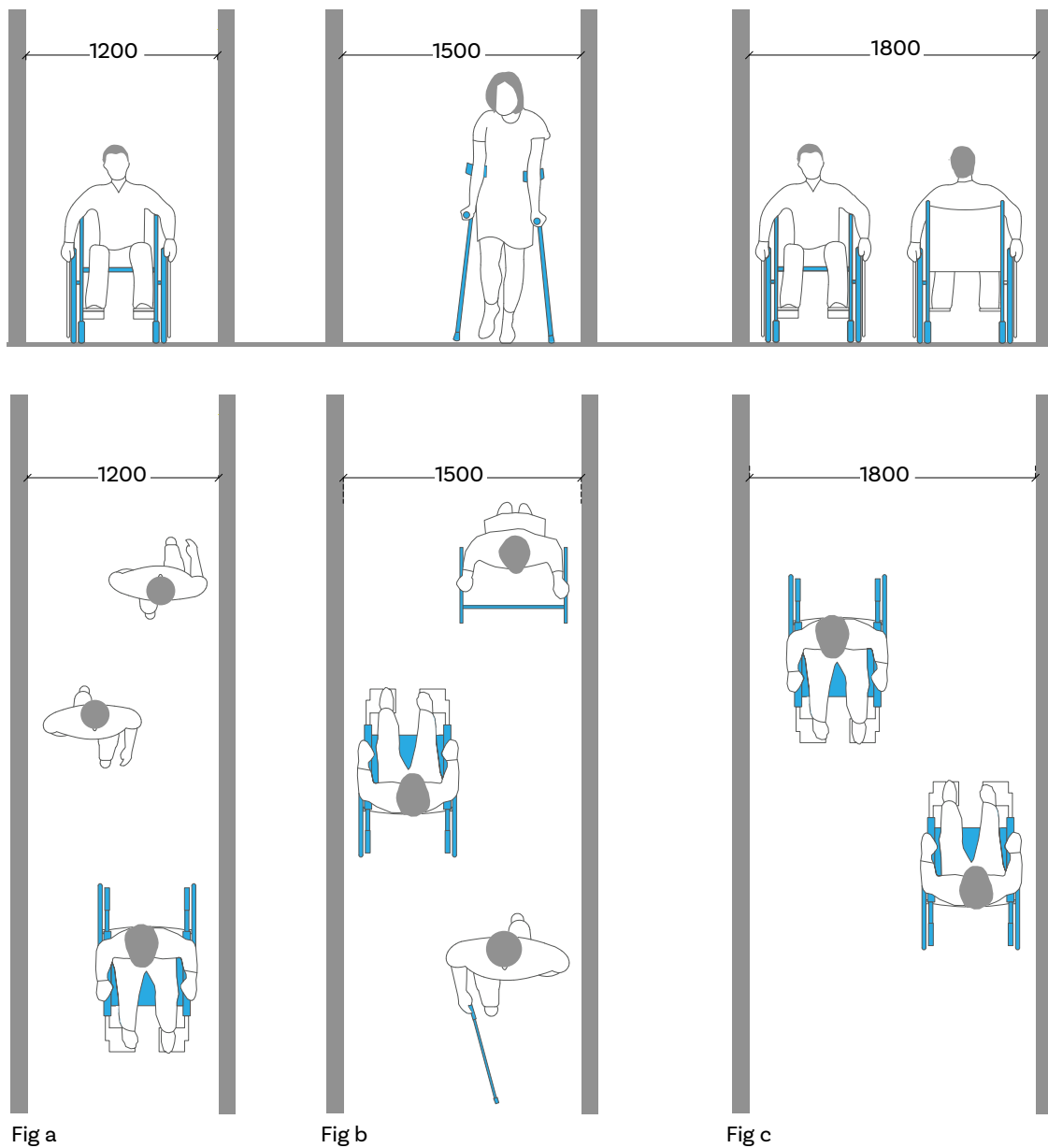


Fig a

Fig b

Fig c

Figure 4.6 Accessible corridor widths for diverse contexts



routes, it may be ensured that they provide a convenient and a supportive environment in moving through it. This may imply incorporating features like adequate widths, provision of grab rail supports, visual contrast and adequate illumination along with guiding signage and routes for emergency exits. Following are the elaborate recommendations:

#### 4.4.1 Width

1. The minimum clear width of 1200mm is recommended for a one way travel direction for persons using wheelchairs or others with high support needs. Refer Fig: 4.6(a)
2. The minimum clear width of an accessible route should be 1500mm minimum to allow both a wheelchair and a walking person to pass except when additional manoeuvring space is required at doorways. Refer Fig: 4.6(b)
3. Where space is required for two wheelchairs to pass, the minimum clear width should be 1800mm as seen in Fig: 4.6(c)
4. Within office work areas, the minimum width for accessible routes must be at least 900mm.
5. An accessible checkout lane must be at least 900mm.

#### 4.4.2 Resting benches/seats

1. In long paths of travel resting areas should be provided at frequent intervals not exceeding 50 meters.
2. Provision of armrests should be made available to aid elderly or persons with disabilities to seat themselves and get up without any external assistance.
3. The height of seats should be between 450 mm and 500 mm. Further,

they shall comply to seating space requirements as stated in Section 4.2.

#### 4.4.3 Protruding objects

1. Obstacles, projections or other protrusions must be avoided in pedestrian areas such as walkways, halls, corridors, passageways or aisles.
2. Protruding objects, if any, must not reduce the clear width required for an accessible route or manoeuvring space.
3. Objects with a height lower than 1000 mm can create a hazard for blind or partially sighted people. Permanent equipment that cannot be located outside the boundaries of a path shall be:
  - a. designed to be easily seen with a minimum difference in LRVs of 30 points to the background;
  - b. shielded to protect against impact; and
  - c. accompanied by a feature that warns of the presence of a potential hazard and is detectable for a person using a white cane or stick.
4. Undetectable objects attached to a wall
  - a. Objects or obstructions, with their leading edges at any height above 600 mm from the floor level must not protrude more than 100 mm into pedestrian areas. Refer Fig: 3.32 & Fig: 3.33
5. Detectable objects attached to a wall
  - a. Objects or obstructions, with their leading edges up to a

maximum height of 600mm from the floor level, may protrude more than 100 mm into pedestrian areas.

6. Common protrusion elements in internal corridors like hanging window air conditioners, fire extinguishers, boxes, almirahs, etc. need to be within a detectable range to ensure safety for persons moving through these spaces.

#### 4.4.4 Free Standing Objects

1. Free standing objects placed between the height of 600 mm and 2000 mm from the floor level must have an overhang of 300 mm or less.
2. Planters and door mats as protruding objects can cause mobility challenges to persons with visual impairments, wheelchair users and others. They should either be accommodate in designated alcoves or identified locations.

Potentially hazardous objects or obstructions are noticed only if they are within the detection range of white canes. Persons with visual impairments, walking towards an object or obstruction can detect an overhang if its lowest surface (leading edge) is 600 mm or less from the floor level.

#### 4.4.5 Floor surfaces in corridors

1. Floor surfaces should be stable, firm, level and slip-resistant.
2. Should not have any drop or unexpected variations in levels.
3. Contrast with the walls in tone and colour, otherwise the skirting must
4. Provide a clear distinction between the floor and wall; and
5. Where there is a change in level, have contrasting colour bands and detectable warning surfaces provided to alert users of the change in level.



Image 4.5 Internal corridor with tactile tiles

Photo Credits: Dr. Gaurav Raheja

6. It is recommended to avoid carpeting. If carpet is used, it should be fixed firmly with a pile not higher than 12mm.
7. Wherever there is a transition of flooring, say from Carpet to Tile Flooring, a transitions strip in the form of a flat floor trim should be provided in the entire length of the transition in order to ensure smooth movement of wheelchair.

#### **4.4.6 Lighting & Signage**

1. Lighting in a corridor should be even, diffused and without glare, reflections or shadows.
2. Minimum illumination level in the corridor should be 150 lux.
3. Ambient lighting in the corridors shall enhance visual contrast to ensure legibility of various elements in the route.
4. Internal circulation routes shall provide clear, legible signage system for various amenities, spaces including emergency signs with exit routes.

#### **4.4.7 Doors leading into corridors**

1. Doors should not open outwards from rooms directly into a frequently used corridor, with the exception of doors to accessible toilets and service ducts.
2. Where a door opens into an infrequently used corridor such as emergency exit, the corridor width should allow a clear space of 900 mm within the corridor when the door is open (Refer Section 4.10). Such doors should be located clear of any sloping floor surfaces in the corridor.
3. Any door that opens towards a frequently used corridor should be

located in a recess at least as deep as the width of the door leaf.

4. The leading edge of any door that is likely to be held open should “contrast visually” with the remaining surfaces of the door and its surroundings to help identification by visually impaired people. The architrave should contrast visually with the wall surfaces surrounding the doorway.

#### **4.4.8 Tactile Guidance Paths and Handrails**

1. Along the accessible corridor and route connecting the entire building, a tactile floor guidance path for independent movement of persons with visual impairments should be provided.
2. Alternately, handrails with braille plates indicating specific location shall be provided on both sides of the corridors.
3. Handrails to be provided at two levels in corridors to aid persons with visual impairments in navigating the space. The handrail dimensions should be in accordance with Section 3.11.
4. Tactile guiding systems should ensure ease in access and egress through horizontal circulation routes in the buildings including in emergency situations like fire, earthquakes, etc.

#### **4.5 Staircase**

Vertical circulation in buildings needs to consider multiple options of transporting people from one floor or level to another as diverse user groups have special needs to accommodate for. Persons with ambulant disabilities, persons with neurodiversity, elderly, children or pregnant women may find it challenging to use staircases



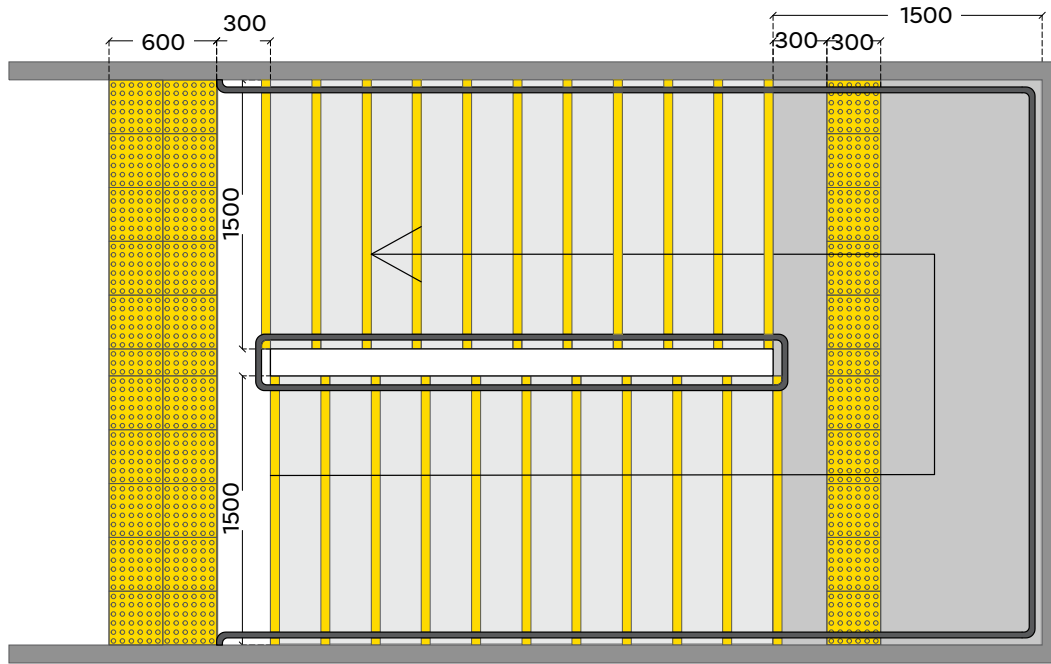


Fig a: Staircase plan showing color contrast and tactile tiles

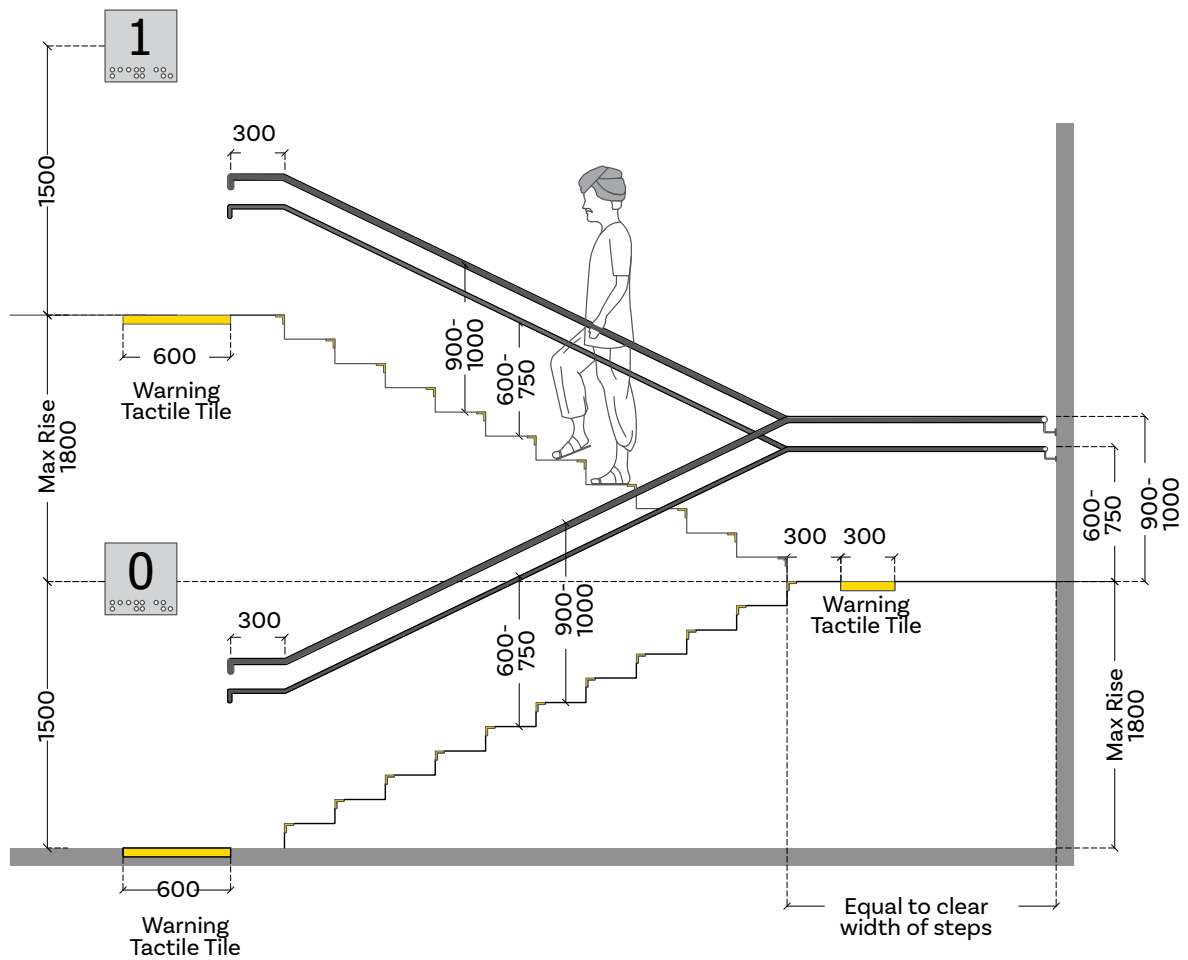


Fig b: Typical staircase section with various accessibility features

Figure 4.7 Staircase details with accessibility features



Image 4.6 Staircase with color contrast and tactile tiles  
Photo Credits: Dr. Gaurav Raheja

under regular conditions with a need for special adaptation or support. However, staircase remains one of the most common modes of vertical circulation for all building typologies which needs to consider the following recommendations to make them universally accessible and convenient for all.

Staircase needs to be easily locatable in any building system, considering first time visitors as well. This could be supported with well defined signage and a simplified building plan.

1. Stairs should not be the only means of moving between floors. They should be supplemented by lifts (Section 4.7) and or ramps (Section 4.6).
2. Treads should be 300 mm deep and risers not higher than 150 mm.
3. Each flight of stairs shall have a maximum of 12 steps.
4. Open risers and transparent treads are not recommended for any staircase design.
5. The stairs landing should be minimally 1200mm deep. The landing must be free of all obstacles and the dimensions should be clear of any door opening.
6. The stairs should have a minimum clear width of 1500mm.
7. Steps should be of a consistent height and depth throughout the staircase.
8. Projecting nosing and open stairs should not be provided to minimize the risk of stumbling.
9. It is recommended to avoid providing spiral stairs.
10. Handrail for stairs should

a. Comply with Section 3.11

b. Extend not less than 300 mm beyond the top and bottom step (Refer to Fig: 4.7)

c. Be mounted at two levels i.e. 600mm to 750 mm for lower handrail and 900 mm to 1000 mm for upper handrail.

d. Have tactile and braille signs installed.

e. Stairs and ramps with a change in level greater than 500 mm must have continuous handrails on both sides with a 300 mm horizontal extension at its ends.

f. When the stair widths are greater than 2100 mm an additional intermediate handrail should be installed. The width between intermediate handrails should be at most 2100 mm.

11. Warning blocks should be installed 300 mm before the beginning and 300 mm after the end of each flight of steps (Fig: 4.7) to aid people with visual impairments.
12. Illumination at the top and bottom and along of the flight should be at least 200 lux.
13. There should be high colour contrast between landings and the steps. It safeguards climbing up or down for all including persons with low vision.
14. Step edges must contrast in colour to the risers and the treads. Contrast colour bands 50 mm wide should be provided on the edge of the tread (Fig: 4.7).
15. The headroom along a path shall be maintained at a height of not less than 2100 mm above the surface of the path.
16. Any objects projecting more than 100 mm between 300 mm and 2100 mm above ground level into an access route shall be clearly visible and detectable with a cane.
17. The staircase should be well maintained with focus on each of its elements. For eg. Step



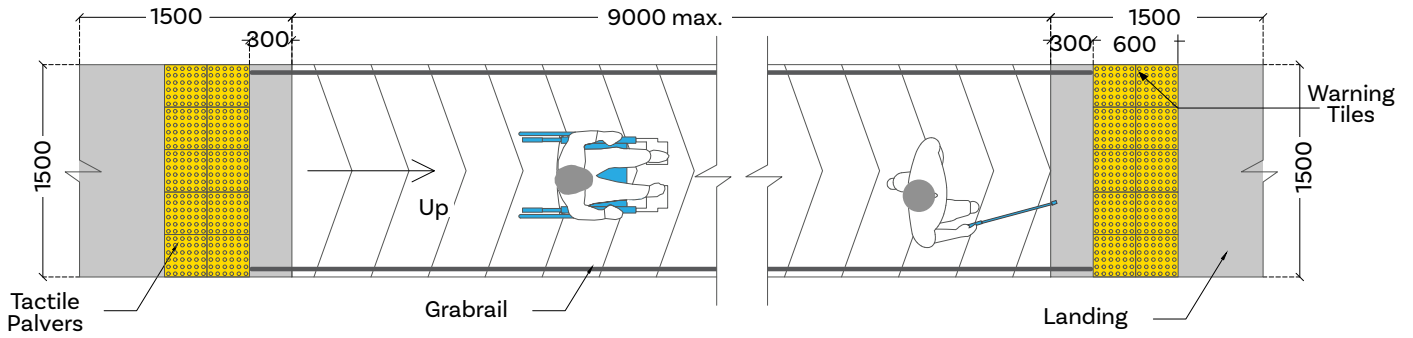


Figure 4.8 Typical details of Straight ramp

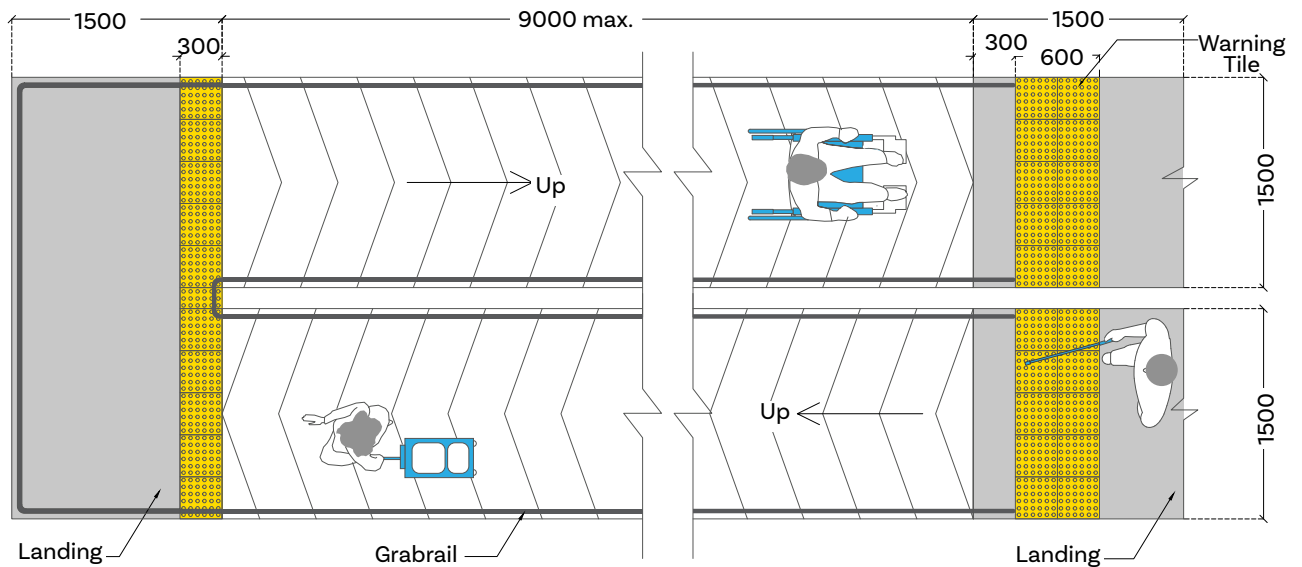


Figure 4.9 Typical details of 'U' Shaped ramp

nosings, handrails, etc. require to be periodically reviewed for wear and tear to prevent falls.

#### 4.6 Internal Ramps

Internal Ramps refer to slopes for circulation within a building premises usually from one floor or level to another. While designing internal ramps, it shall

be considered to keep the slopes gentler and not steeper than 1:12. It is also recommended to preferably adopt a gradient of 1:15 or lower as a principle of good practice and to enable independent mobility to the greatest extent possible. It is important to note that ramps require to be well laid and implemented keeping in mind the needs of persons with disabilities esp. wheelchair users along with ones requiring high support needs or persons with neurodiversity who may

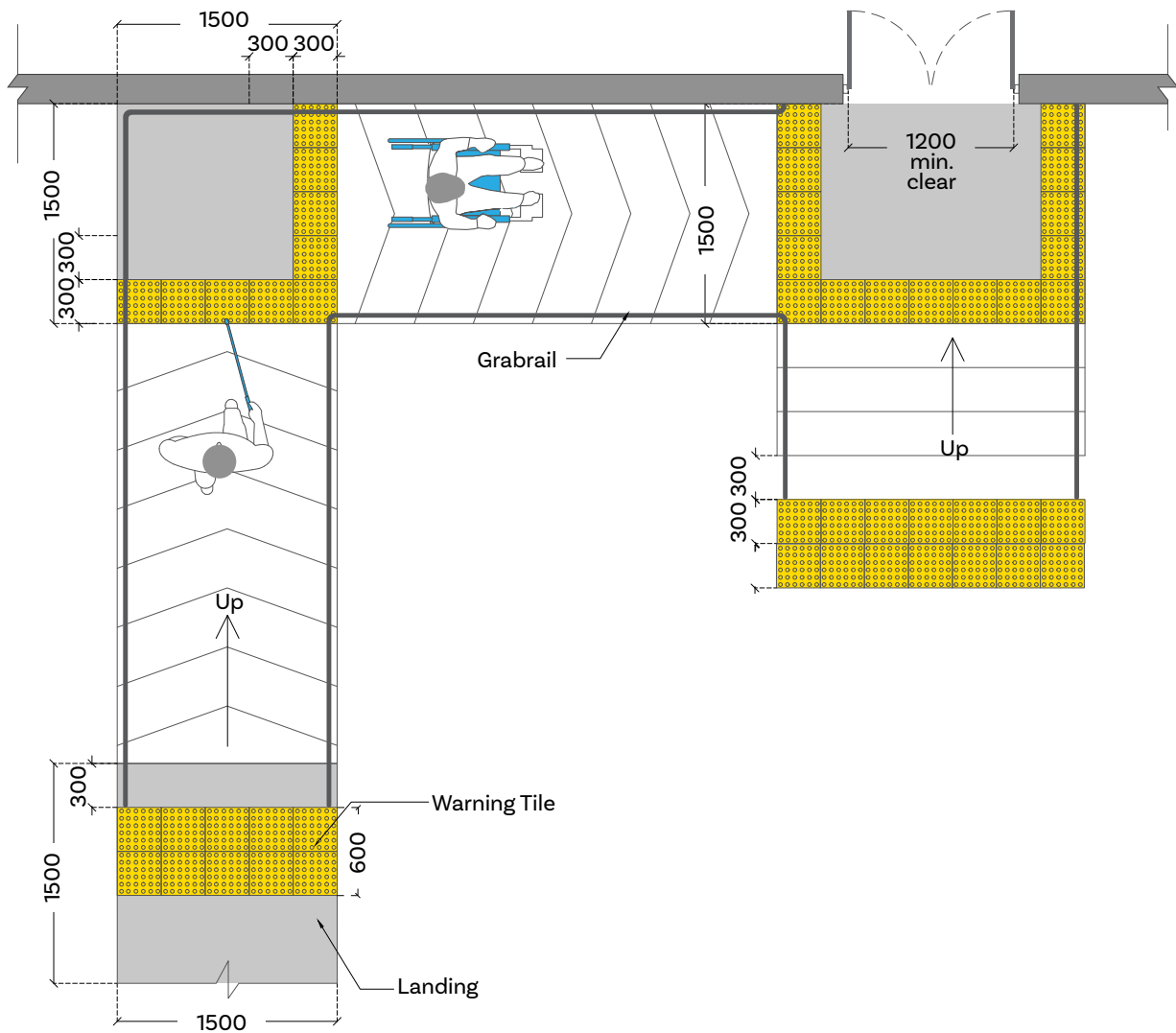


Figure 4.10 Typical details of 'L' Shaped ramp with steps: Type A

also require additional support.

While designing new buildings, ramps should be well integrated as a feature of the building itself and be executed in spirit of universal design. However, if ramps are required to be built as retrofitting measures then also it is recommended to integrate through form and material finishes with the existing building to avoid any stigmatizing look.

Several attributes of ramps like slopes or gradient, lengths and widths, handrails,

mid landings, floor finish and detailing, edge protections and few other aspects together make a ramp universally accessible and inclusive. It is important to realise that a steep slope or faulty design of ramp can cause more risks to safety of persons with disabilities besides inconvenience to others. This includes some of the common yet erroneous practices like rumbled floorings with polished stone finish, slippery floor finishes, absence of handrails at two heights, inadequate lighting, inadequate visual contrast, etc.

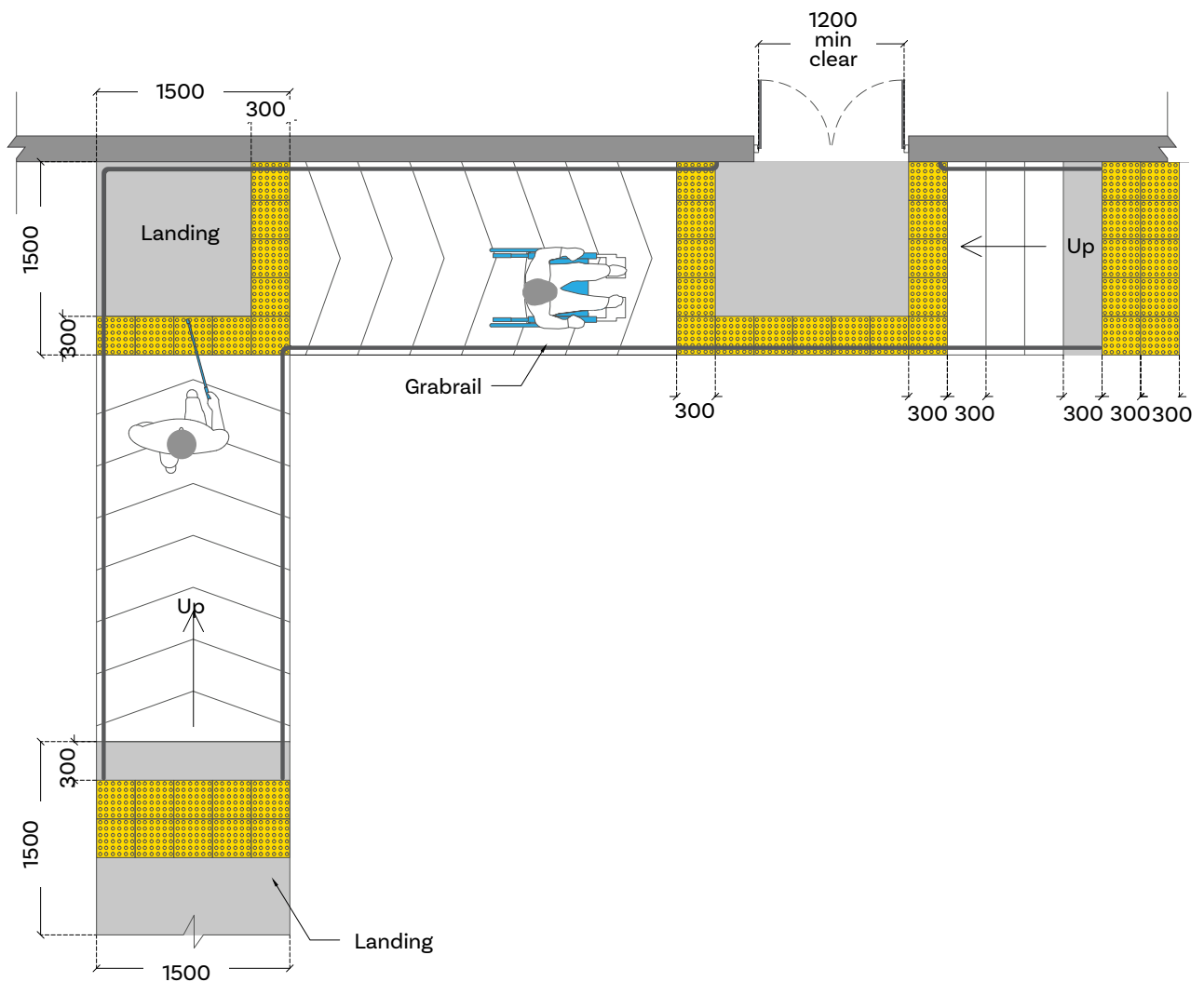


Figure 4.11 Typical details 'L' Shaped ramp with steps: Type B

The key recommendations as specified in Section 3.10 shall be applicable for the design and implementation of internal ramps also. Few additional considerations as proposed shall imply.

1. Internal Ramps shall be easily locatable and be near to other alternate means of vertical circulation like staircase, lifts, etc. Adequate signage system in contrasting colours shall guide individuals to the ramps inside the building premises.
2. Tactile guiding systems shall guide the persons with visual impairments to the beginning of ramp from the

main entrance of the buildings.

3. The flooring surfaces shall be non slippery and shall align to the floor finishes of the floors at both levels. The floor joinery between the ramp and the connecting floor needs to be carefully integrated ensuring a smooth transition avoiding water collection.
4. Other features like provision of mid landings, edge protections, etc. shall comply with Section 3.10.
5. Handrails shall be placed at two levels in compliance with Section 3.11 with tactile or braille signs at the handrail extensions indicating floor levels.



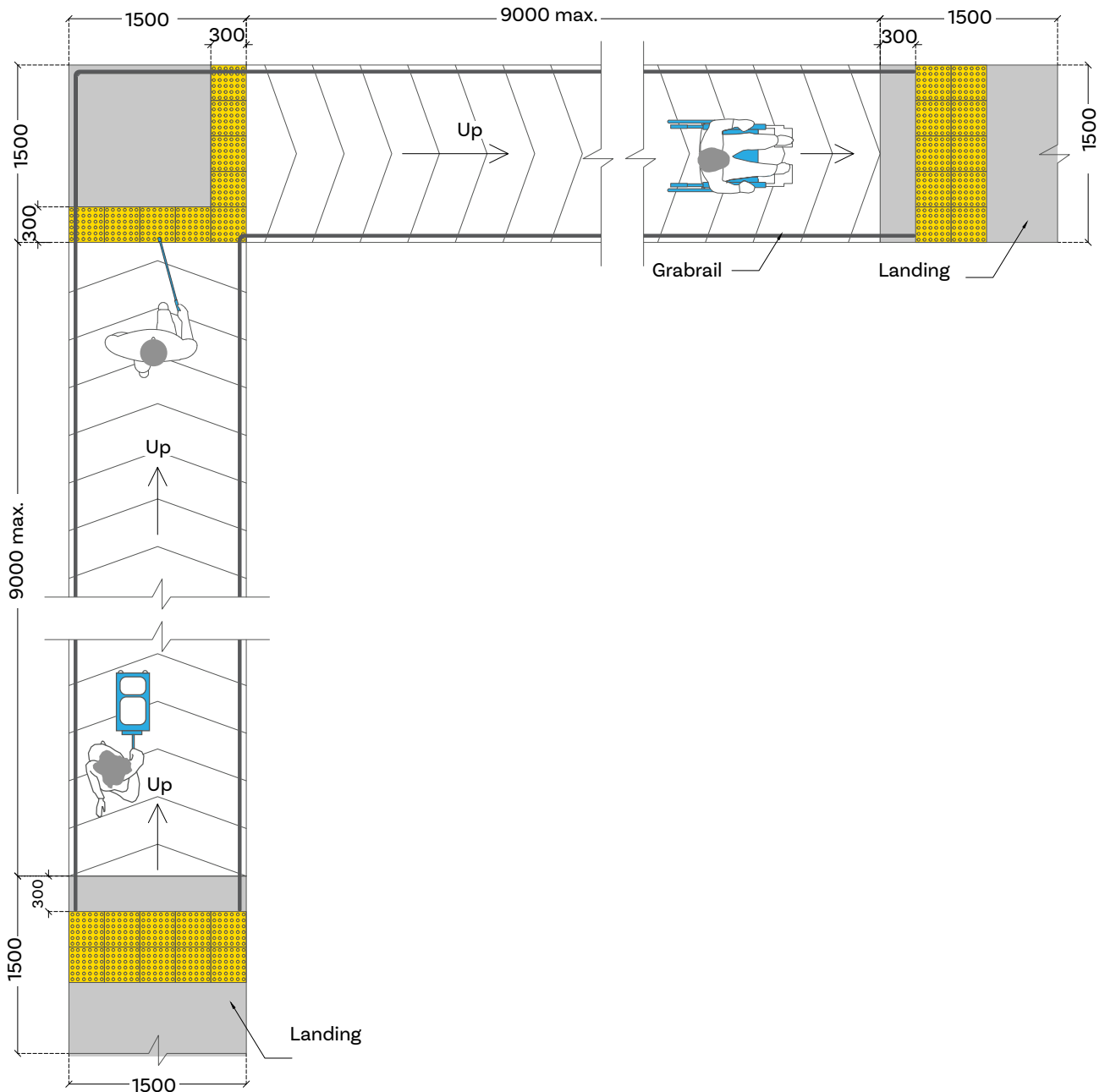


Figure 4.12 Typical details of L Shaped ramp: Type C

6. As one moves up or down the ramp, it is important to place the floor signage and other related wayfinding signage at the same floor level.
7. Ramps shall be well covered to protect diverse users from moving up or down the ramp in harsh weather conditions like extreme heat or rain,
8. It is recommended to avoid circular or spiral profiles for ramps. If used, the recommended gradients for them shall be 1:16 or higher.
9. Ramps shall be maintained regularly against any defects or repairs besides regular cleaning services.

etc.

## 4.7 Lifts and Escalators

Lifts are a mechanical means of vertical circulation with wide ranging acceptance and application in diverse building typologies. They play a crucial role in enhancing the accessibility and connect between various floor levels. It is therefore relevant to understand the wide ranging needs of persons with disabilities, elderly and others, while planning and designing a lift system for a particular building complex. There can be several variants of lifts in terms of design, finishes and technologies. However, few foundational aspects as following recommendations shall be complied.

### 4.7.1 Lift Location & Size

1. Lifts shall be conveniently located and appropriately guided from the entrance by signage and tactile guiding systems to the lift lobbies in all building typologies.
2. The minimum size of the lift should be 1900 mm x 1900 mm for all new establishments. This would enhance vertical mobility for all including those using powered wheelchairs. In case where the space is not available, the lift size shall be a minimum of 1500 mm x 1500 mm (Fig: 4.13).
3. It is recommended to install a 13 passenger lift which allows easy manoeuvrability for wheelchair users, baby strollers and other wheeling devices.

### 4.7.2 Lift Door

1. The lift door should have a clear opening of not less than 900 mm and contrasting in colour from the

adjoining wall.

2. There should be no difference in level between the lift door and the floor surface at each level. The gap between the lift door and building floor should not be more than 12 mm.
3. Doors shall open automatically and shall remain opened at least 3 seconds.
4. Time of closing of an automatic door should be more than 5 seconds and the closing speed should not exceed 0.25 meters per second.
5. It is recommended that lift doors have a vision panel to enable persons with hearing impairment to signal for help or assistance in the event of an emergency. Further an appropriate technological support be provided (through CCTV intercom or emergency messaging services or alarms, etc.) to respond to the emergency requirements of person with hearing impairment or deafness.
6. If there is a user in the doorway, the door shall automatically reopen and shall not produce a force greater than 135 N. Sensors should be at two levels to ensure that it detects lower items.

### 4.7.3 Call Button

The call button located outside the lift should:

1. Have a clear floor space of at least 900 mm x 1200 mm with no obstruction placed to prevent a wheelchair user from reaching the call button.
2. Be installed at a height between 800 mm and 1000 mm (Fig: 4.15).
3. Call buttons in each floor can contain icons instead of digits in tactile and colour contrasted against the background.



Image 4.7 Accessible Lift door  
Photo Credits: Dr. Gaurav Raheja



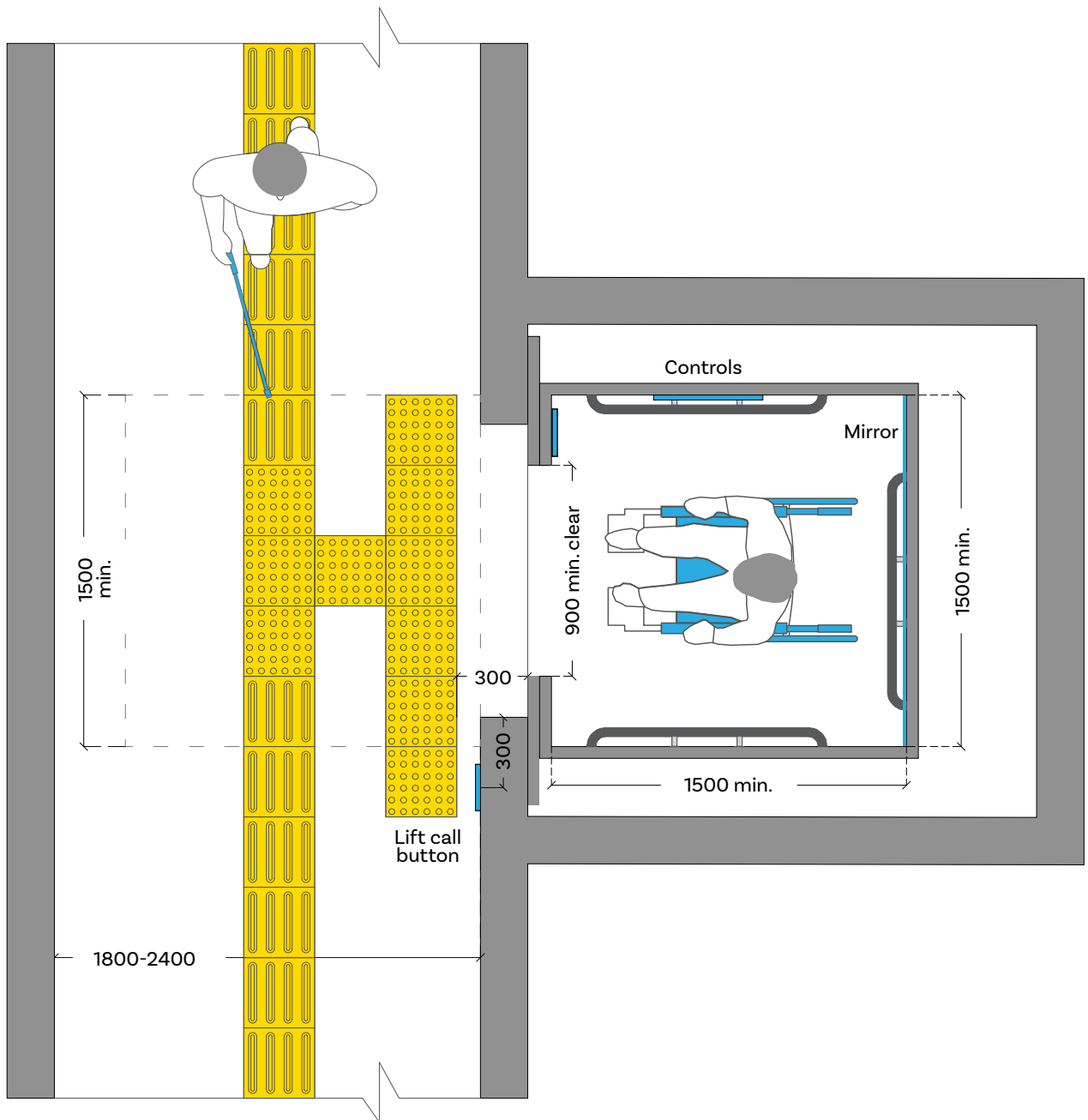


Figure 4.13 Accessible lift car layout and controls

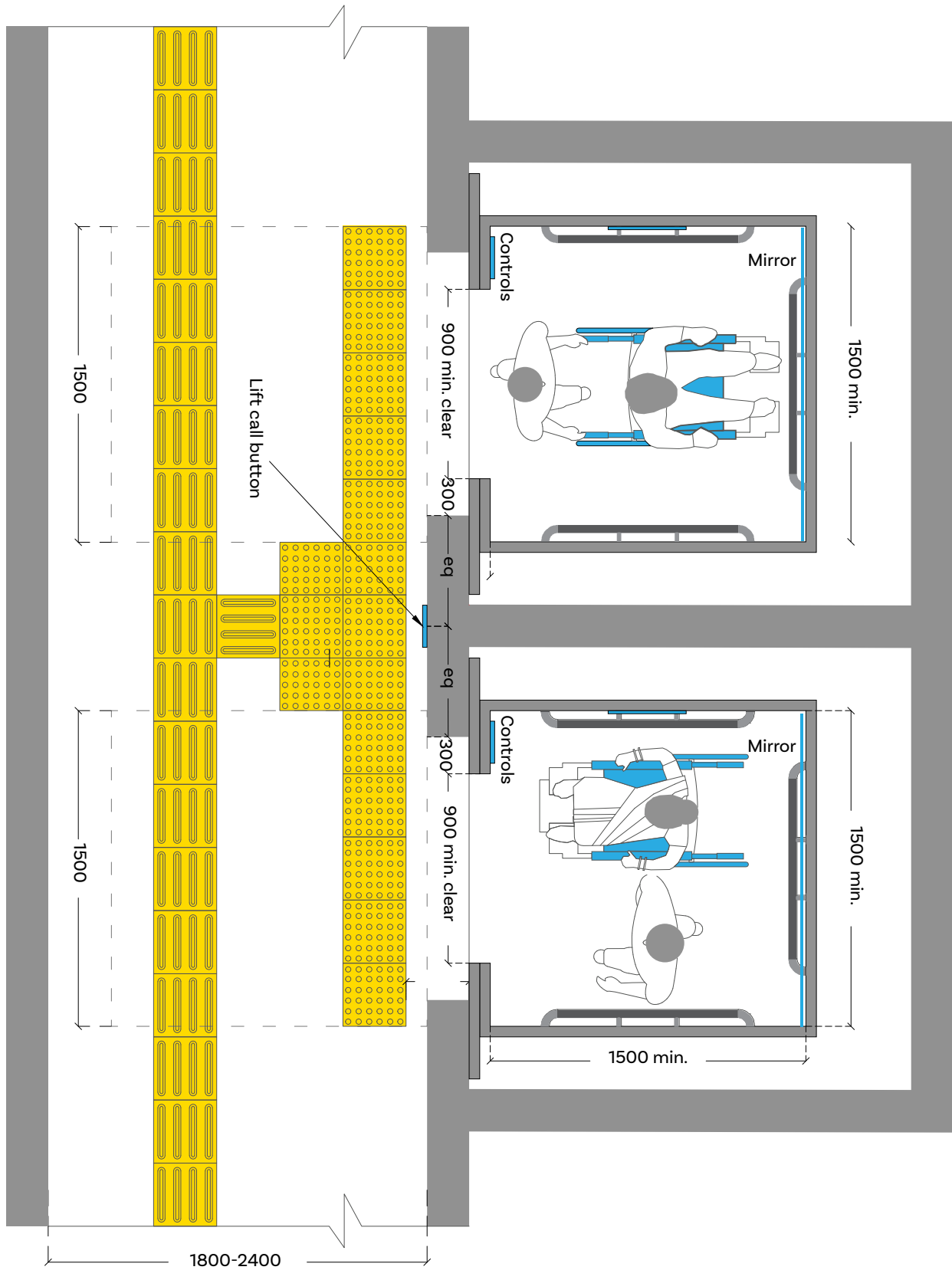


Figure 4.14 Accessible lift cars in parallel layout

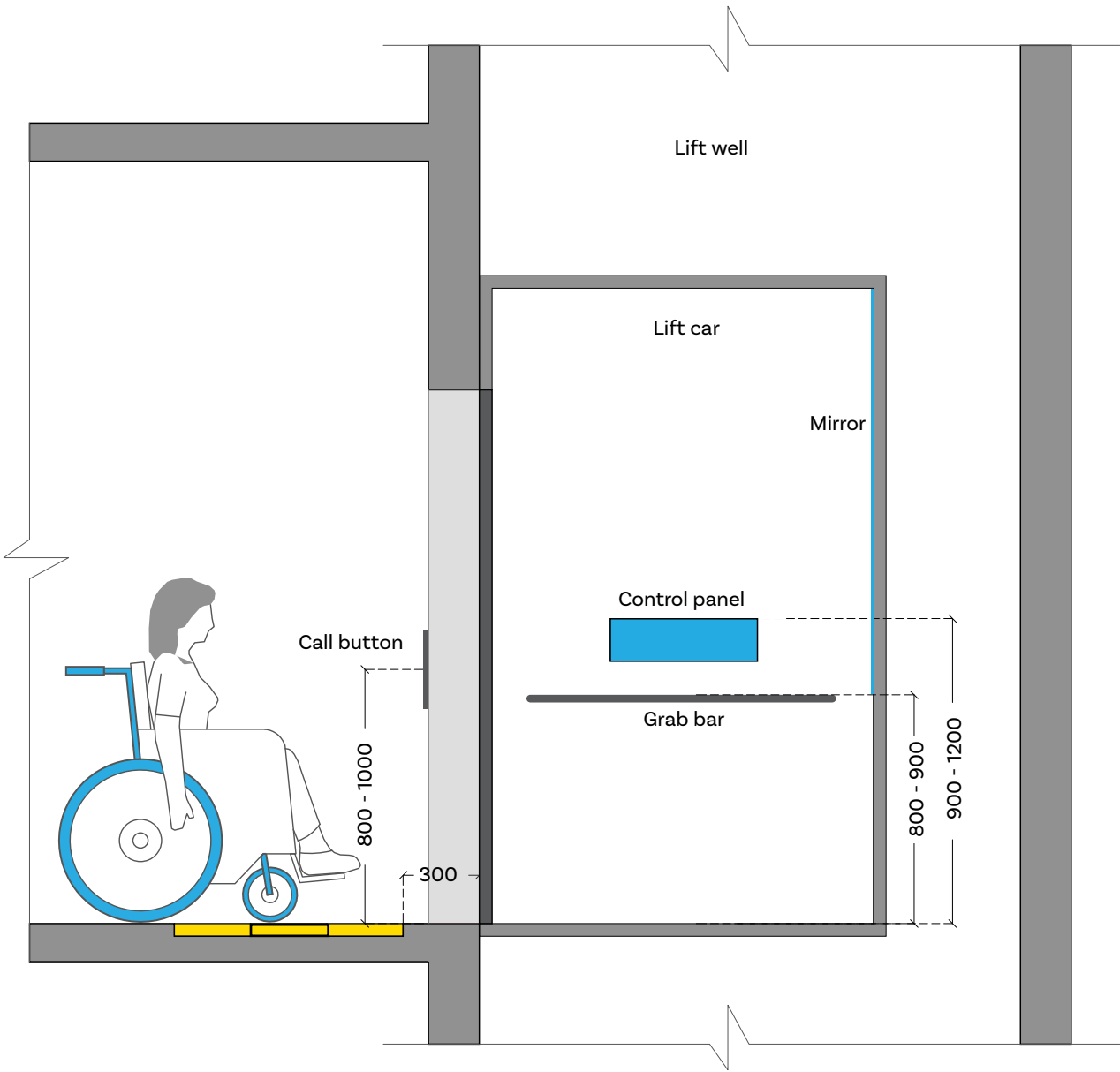


Figure 4.15 Typical section of an accessible lift car





Image 4.8 Accessible call buttons in the lift  
Photo Credits: Dr. Gaurav Raheja

- Buttons shall always provide a two-channel feedback when pressed: visual and acoustic or visual and tactile.

#### 4.7.4 Control Panel

The control panel should:

- Have a clear floor space of at least 900 mm x 1200 mm with no obstruction placed to prevent a wheelchair user from reaching it.
- Be placed at a height of between 900 mm to 1200 mm from the floor level.
- To provide equidistant access to

control panel buttons, especially for independent wheelchair users or others, the control panel shall be placed horizontally. For elevators serving buildings with ten floors or above, both panels are recommended.

- Have buttons with Braille/ raised letters and in sharp contrast from the background to aid people with visual impairments. Touch sensitive buttons or keypads shall be avoided.

#### 4.7.5 Grab Bars

Grab bars in lifts should:

- Comply with Section 3.11





Image 4.9 Tactile pavers layout towards the lifts access  
Photo Credits: Dr. Gaurav Raheja





Image 4.10 Accessible control panel in the lift  
Photo Credits: Dr. Gaurav Raheja

2. Be placed at a height of 800 mm to 900 mm from the floor level. (Refer Fig: 4.15)
  3. Be fixed on both sides and at the rear of the lift.
  4. Be allowed to have a gap of 150 mm or less if it is not continuous.
  5. Grab bars should be constructed such that there are no open ends to cause hooking when used by passengers.
1. The lift should have a voice announcement system along with a visual display to indicate the floor level and also the information that the door of the elevator is open or closed for entrance or exit.
  2. The announcement system should be clearly audible i.e. the announcement should be 50 dB.
  3. The emergency bell in the lift must be connected to a blinking light in the lift car to signal to persons with hearing

#### 4.7.6 Audio and Visual Indicators





*Everything is not meant for kids to play with!  
This chair lift is NOT a ride!  
It is our gratitude towards the elderly/less abled,  
Please don't make fun of it...*



Image 4.11 Wheelchair stairlift  
Photo Credits: Dr. Gaurav Raheja



impairments that the emergency bell has been activated.

4. Lighting levels of a minimum of 100 lux is recommended for all lifts in building systems.

#### 4.7.7 Other facilities

1. The use of visually and acoustically reflective wall surfaces should be minimized within the lift car as visual reflections can cause discomfort and affect the visual acuity of people with visual impairments.
2. The floor of the lift car should be slip resistant and have similar frictional qualities to the floor of the lift landing to decrease the risk of stumbling.
3. The provision of a mirror on the wall of the lift car opposite the lift door is a positive aid to navigation for wheelchair users. It allows the wheelchair user to see if anyone is behind them and also to see the floor indicator panel. The mirror should not extend below 900 mm from the lift

floor to avoid confusing people with visual impairments.

4. The emergency communication system should be coupled with an induction loop system installed all around the lift. Telephone units, where provided, should have an inbuilt inductive coupler to assist persons using hearing aids.
5. Destination control systems shall be preferred to enhance lift efficiency and reduce waiting times.

#### 4.7.8 Lift signage

1. Where lifts are provided in a building they shall be accessible to and usable by Persons with Disabilities at all levels used by the general public or staff. Elevators should be marked with the symbol of accessibility and directional signs be provided to the lifts.

#### 4.7.10 Travellers, Escalators and Mechanical ramps

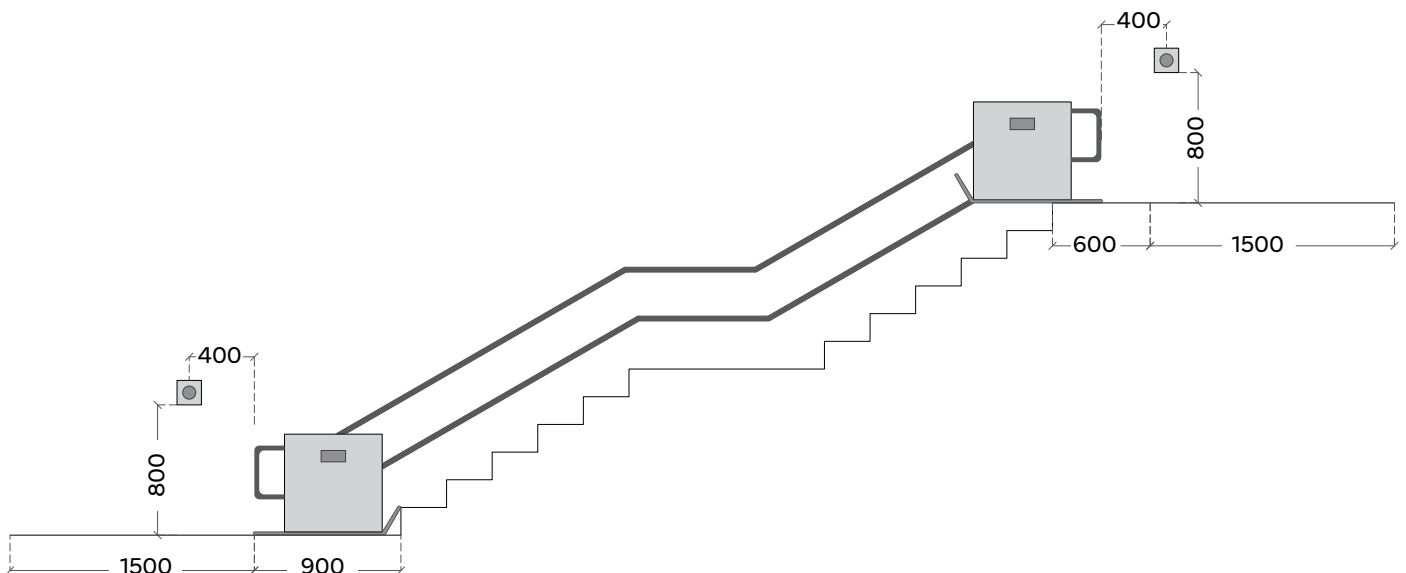


Figure 4.16 Wheelchair platform stairlifts for straight staircase



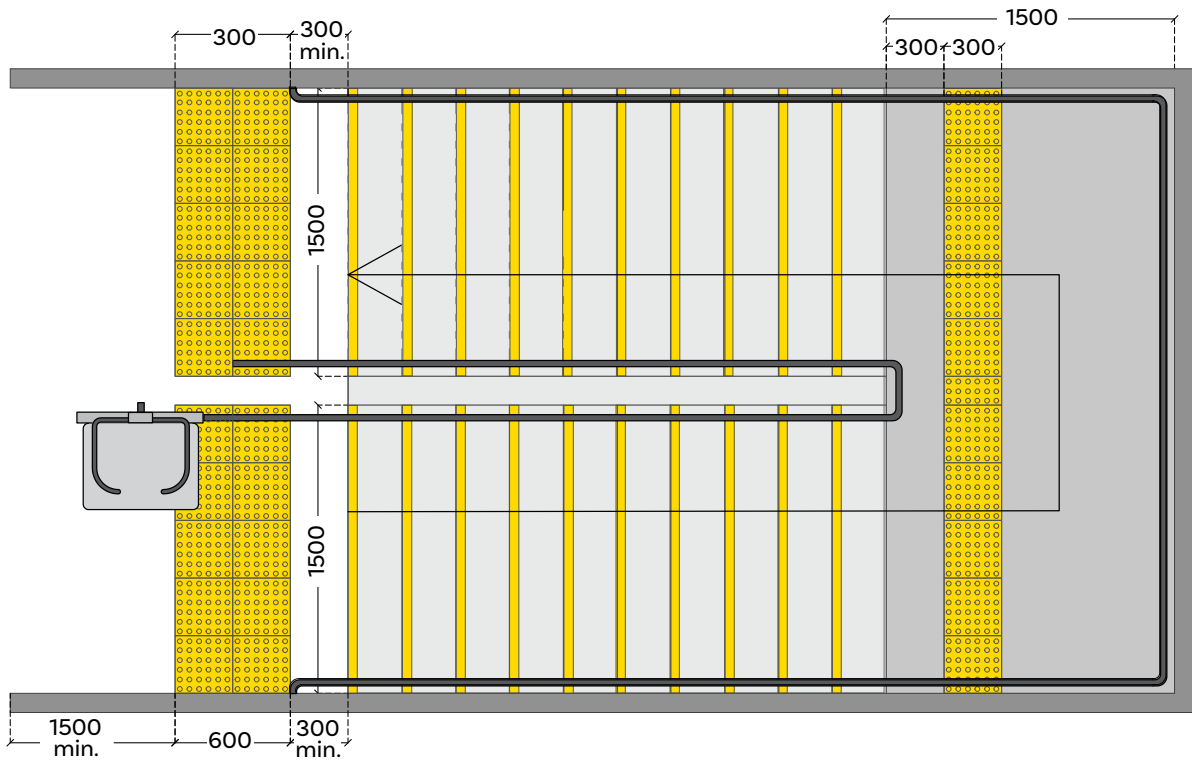


Fig a: Staircase plan showing wheelchair platform lift and tactile tiles

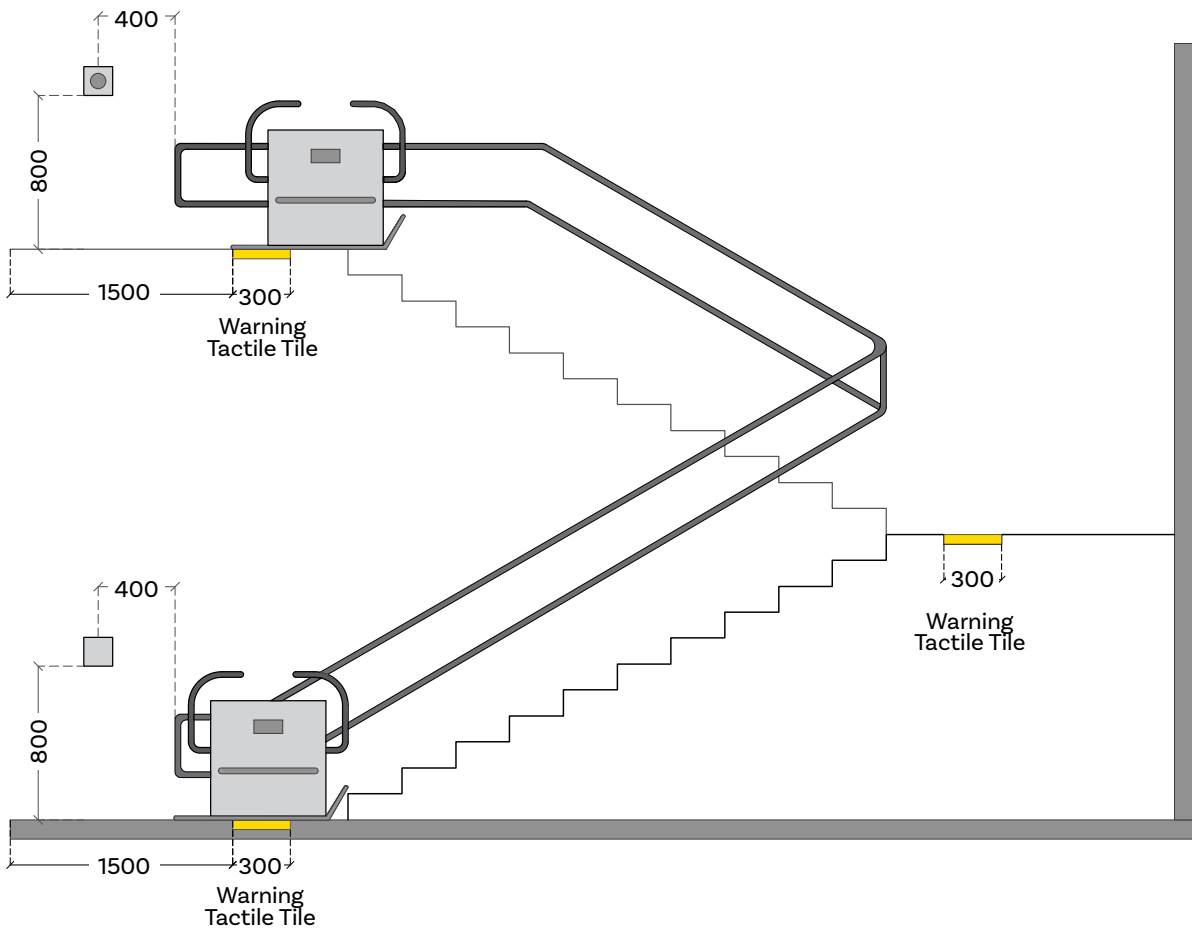


Fig a: Staircase section showing wheelchair platform lift and tactile tiles

Figure 4.17 Wheelchair platform stairlifts for 'U' shaped staircase

1. Signs indicating the location of an accessible lift should be provided in a location that is clearly visible from the building entrance. The sign should incorporate a representation of the International symbol for access.
2. A sign indicating the number of the floor should be provided on each lift landing on the wall opposite the lift. It is also recommended to install a floor directory of the main facilities and services available on the lift landing, along with an accessible emergency egress route that clearly indicates the location of nearest refuge areas for persons with disabilities.

#### 4.7.9 Platform Lifts and Wheelchair Stairlifts

Where it is impracticable to provide a lift or a ramp, a wheelchair stair-lift or platform lift should be considered as a reasonable alternative for vertical circulation within the building. Existing buildings in challenging terrains, high plinths and with compact spaces may consider these assistive technologies or other state of the art possibilities to provide access in an uncompromising manner. Pilgrimage shrines and other public buildings with steep levels and steps, where a high footfall of elderly is expected in addition to others with disabilities, it is appropriate to install

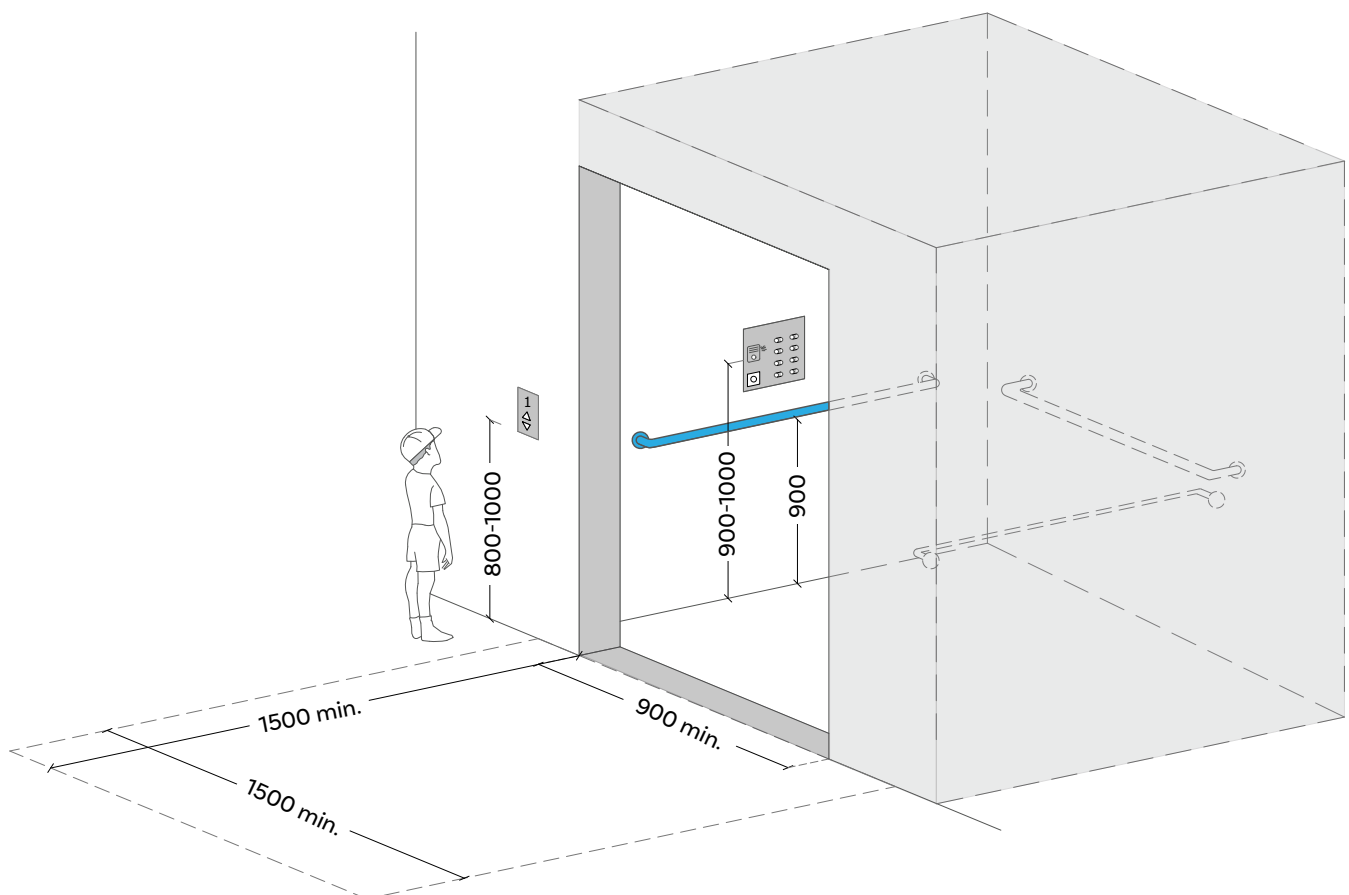


Figure 4.18 Lift platform dimensions

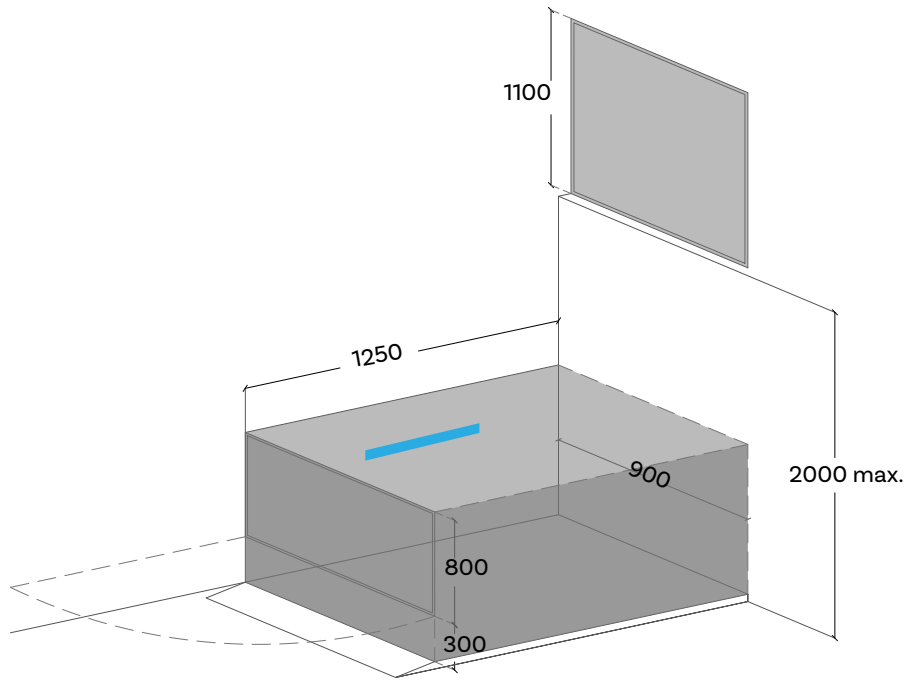


Figure 4.19 Platform lift

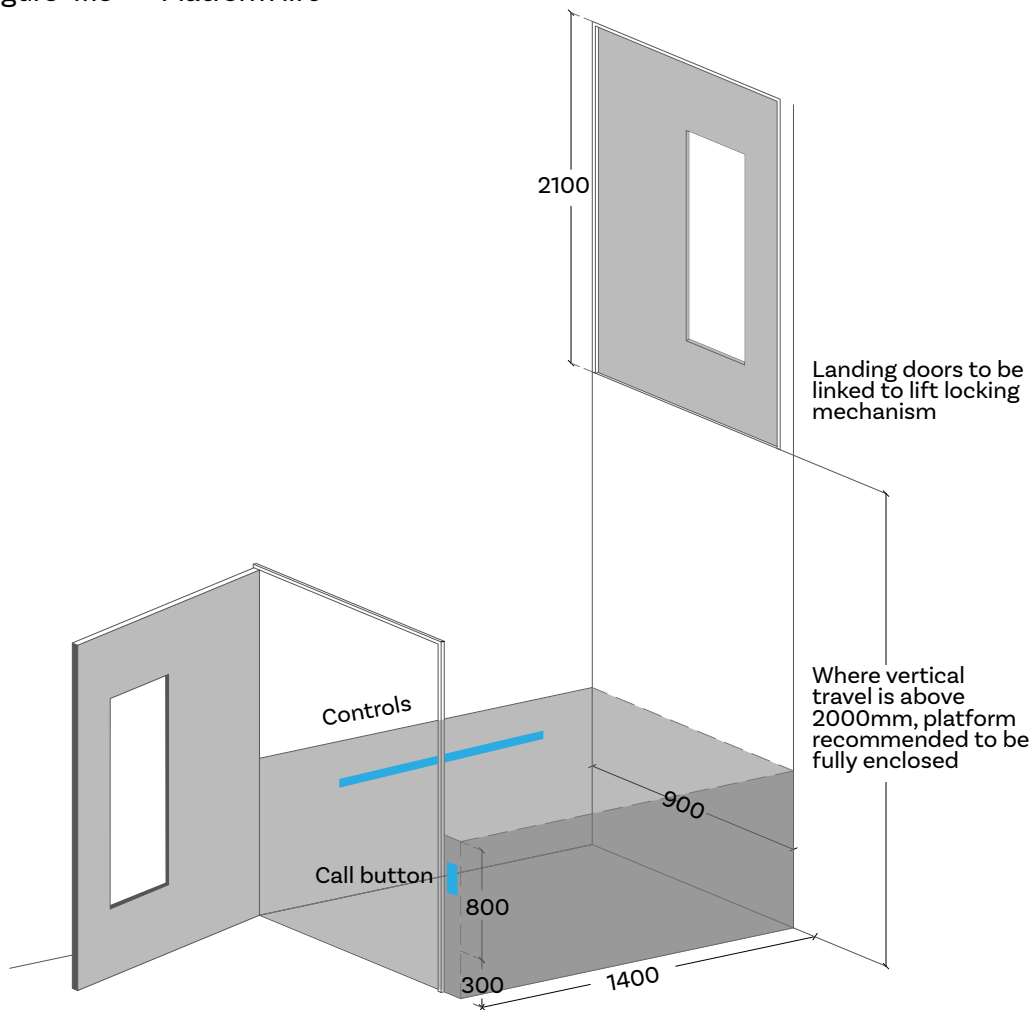


Figure 4.20 Enclosed platform lift



1. Signs indicating the location of an accessible lift should be provided in a location that is clearly visible from the building entrance. The sign should incorporate a representation of the International symbol for access.
2. A sign indicating the number of the floor should be provided on each lift landing on the wall opposite the lift. It is also recommended to install a floor directory of the main facilities and services available on the lift landing, along with an accessible emergency egress route that clearly indicates the location of nearest refuge areas for persons with disabilities.

#### **4.7.9 Platform Lifts and Wheelchair Stairlifts**

Where it is impracticable to provide a lift or a ramp, a wheelchair stair-lift or platform lift should be considered as a reasonable alternative for vertical circulation within the building. Existing buildings in challenging terrains, high plinths and with compact spaces may consider these assistive technologies or other state of the art possibilities to provide access in an uncompromising manner. Pilgrimage shrines and other public buildings with steep levels and steps, where a high footfall of elderly is expected in addition to others with disabilities, it is appropriate to install these assistive technologies.

##### **4.7.9.1 General**

1. Platform lifts are special passenger elevating devices for people with disabilities. Platform lifts can have either a vertical or an inclined movement.

##### **4.7.9.2 Vertical Movement Platform Lifts**

1. For maximum level changes of 2500 mm, vertical movement platform lifts may be installed.
2. For level changes of more than 1200 mm, the lift should be placed in a closed structure with doors at different accessible levels.
3. Vertical platform lifts can have a variety of openings for entry and exit.
4. Minimum size should be 1200 x 1000 mm.

##### **4.7.9.3 Inclined movement platform lifts**

1. Inclined movement platform lifts consist of three elements: a railing, an electric generator and a moving platform or seat.
2. Inclined movement platform lifts can be installed along the stair wall as long as they do not obstruct the required width of the exit. The seat or platform can be folded when not in use.
3. The minimum width of the stairs should be 900 mm to allow the installation of the lift.
4. Platform lifts can be installed on all types of stairs including switch back stairs i.e. those with a rotation of 180 and spiral staircases.
5. Inclined movement platform lifts are usually used to connect one or more floors or to overcome split levels in existing buildings.

##### **4.7.9.4 Lift Size**

1. The minimum width of the platform lift should be 1050 mm and the minimum length should be 1250 mm.

Travellators are considered complementary elements of accessible pedestrian paths and shall have the following requirements:

1. The moving surface shall present a maximum gradient of  $\leq 5\%$ .
2. The beginning and the end of travellators shall present a contrasting pavement with the surroundings.
3. The direction of travel shall be marked.
4. It is recommended to install an audio system indicating the start and end of these devices which informs the user before stepping on to the mechanical ramps.

Escalators and mechanical ramps are usually not considered part of the accessible path. However, they do provide a mechanically assisted alternative to vertical mobility in built environments. Legible information and safety signs in color contrasting manner shall be provided to facilitate safety for all users.

Safety and emergency protocols for support shall be readily available in case of any situation faced by persons with disabilities or other users while using the escalators. Whenever provided they shall be accompanied by a non-mechanical accessible alternative route or an elevator that leads to the different levels.

#### 4.8 Accessible drinking water stalls

Drinking water fountain/unit shall be made accessible and inclusive to diverse user groups considering functional limitations and socio-cultural aspects of convenience in drinking water. Following recommendations are being made to ensure accessibility in drinking water provisions:

1. Drinking water facilities in buildings should be easily locatable, identifiable and reachable through well identified



Image 4.12 Accessible Drinking water facility  
Photo Credits: Shreya Shetty

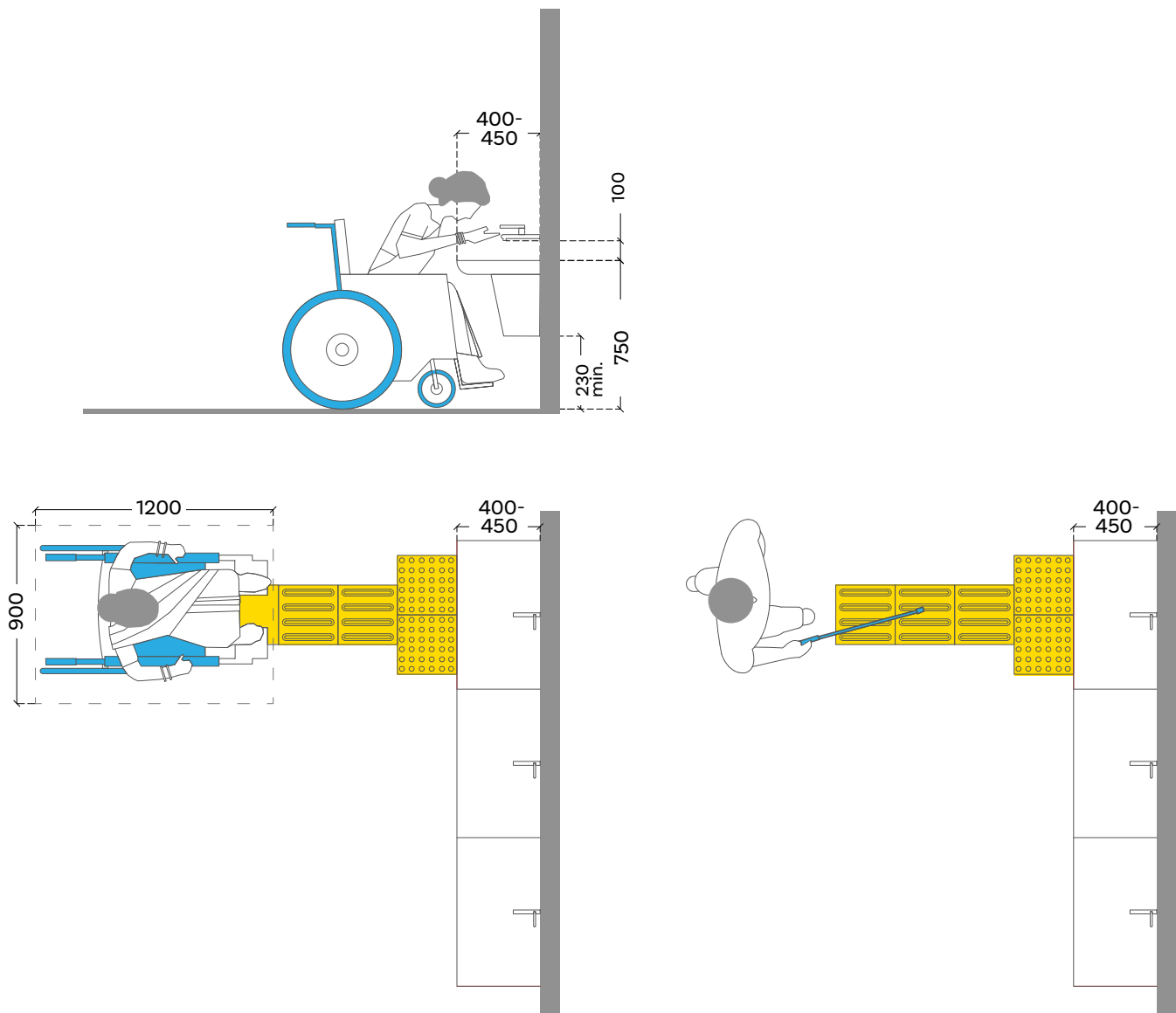


Figure 4.21 Typical layouts for accessible drinking water fountain

signage.

2. Drinking water coolers or taps should:

- a. Have a clear floor space of at least 900 mm x 1200 mm.
- b. Have a clear knee space between the bottom of the apron and floor or ground of at least 750 mm wide, 200 mm deep and 700 mm high.
- c. Have a toe space not less than 750 mm wide and 230 mm high.
- d. Have a provision for water glass.

3. Accessible drinking water fountains

for wheelchair users may be placed at a height of 750 mm with above features. Refer Fig: 4.21

- 4. The drinking water counter may be projected upto 480mm from the edge of the wall surface.
- 5. Freestanding or built-in-drinking water coolers or taps not having a knee space should have a clear floor space of at least 1200 mm wide x 900 mm in front of the unit
- 6. All wall-mounted drinking water provision in an alcove is preferred, because it does not create a hazard for persons with visual impairments.





Image 4.13 Accessible Drinking water fountains  
Photo Credits: Shreya Shetty

7. It is recommended to make provisions of drinking water facilities at two different heights. One between 750 mm to 800 mm range for wheelchair users or persons with low height. The other at 900 mm for which is very convenient for standing adults. Refer Fig: 4.21
8. The 100mm high water flow is to allow for the insertion of a cup or glass.
9. Drinking fountains should provide bottle fillers.
10. A drain should be located under the drinking fountain to prevent the ground surface from becoming waterlogged or muddy.
11. Drinking water faucets shall be easy to operate with lever type handles or other alternative mechanisms like sensor operated taps, etc. to provide

Table 4.1 Design recommendations for universally accessible washroom design

S.NO.	FEATURE	RECOMMENDATIONS
<b>A.</b>	<b>Washroom Spatial Planning</b>	
1	Accessible Washroom size (unisex)	<ul style="list-style-type: none"> <li>• Public Washroom – 2200 mm x 2000 mm</li> <li>• Residential Washroom – 1800 mm x 2300 mm or 1500 mm x 2500 mm</li> <li>• Family Friendly Washroom – 3000 mm x 2200 mm</li> </ul>
2	Accessible WC Cubicle (Both Indian and European)	<ul style="list-style-type: none"> <li>• For European style WC: as per Fig: 4.35 and 4.36</li> <li>• For Indian style WC: as per Fig: 4.37 and 4.38</li> </ul>
3	Circulation Space	<ul style="list-style-type: none"> <li>• Maneuvering space for wheelchairs, baby strollers, rollators, etc. – 1500 mm dia</li> </ul>
4	Lateral Interaction Space	<ul style="list-style-type: none"> <li>• Preferred on both sides for wheelchair transfer</li> <li>• Minimum on one side of the WC.</li> </ul>
<b>B.</b>	<b>Door &amp; Elements</b>	
1	Door Type	<ul style="list-style-type: none"> <li>• Hinged Doors with two way opening ( Preferably a swing clear hinged door)</li> <li>• Sliding Doors</li> </ul>
2	Door Width	<ul style="list-style-type: none"> <li>• 900 mm minimum clear width</li> </ul>
3	Door Handle	<ul style="list-style-type: none"> <li>• Lever Type</li> <li>• Height - 800 mm to 1000 mm</li> </ul>
4	Push bar (inside)	<ul style="list-style-type: none"> <li>• Height - 1000 mm (900 mm to 1100 mm)</li> </ul>
5	Latch / Bolt	<ul style="list-style-type: none"> <li>• Lower Level – 200 mm to 250 mm</li> <li>• Mid Level – 800 mm to 900 mm</li> <li>• Top Level – 1800 mm to 2100 mm (subject to door height)</li> </ul>

S.NO.	FEATURE	RECOMMENDATIONS
<b>C.</b>	<b>Washbasin and related Fixtures</b>	
1	Location	<ul style="list-style-type: none"> <li>• Preferably straight access from the door</li> </ul>
2	Maneuvering Space	<ul style="list-style-type: none"> <li>• 1500 mm dia for wheelchair minimum</li> </ul>
3	Wheelchair Parking Space	<ul style="list-style-type: none"> <li>• 900 mm x 1200 mm minimum</li> </ul>
4	Height of Washbasin	<ul style="list-style-type: none"> <li>• 700 mm to 800 mm</li> </ul>
5	Mirror	<ul style="list-style-type: none"> <li>• Fixation height - 900 mm</li> <li>• Length - Full Length (especially for family friendly facilities)</li> <li>• Tiltable with adjustable mechanism to accommodate users with varying heights</li> </ul>
6	Swing Bar	<ul style="list-style-type: none"> <li>• On both sides</li> <li>• Fixation Height - 800 mm</li> </ul>
7	Soap Dispenser	<ul style="list-style-type: none"> <li>• 700 mm to 800 mm</li> </ul>
8	Towel Rail	<ul style="list-style-type: none"> <li>• 1200 mm to 1500 mm</li> </ul>
9	Hand Dryer	<ul style="list-style-type: none"> <li>• 1000 mm max.</li> </ul>
10	Faucet	<ul style="list-style-type: none"> <li>• Lever Type or Sensor based</li> </ul>
<b>D.</b>	<b>WC - European style and related fixtures</b>	
1	Location	<ul style="list-style-type: none"> <li>• Located in dry zone of the washroom.</li> <li>• Recommended to provide space for lateral transfer preferably from both sides for all new constructions.</li> <li>• However, for existing building typologies min. one side lateral transfer is recommended.</li> </ul>
2	Type and Fixation levels	<ul style="list-style-type: none"> <li>• Wall Hung type</li> <li>• Height - 450 mm to 480 mm</li> <li>• Center Line from wall - 450 mm to 480 mm</li> <li>• Lateral Space (for transfer) - 900 mm x 1200 mm</li> </ul>
3	Grab Bars	<ul style="list-style-type: none"> <li>• Fixed Grab Bar L - Type - 750 mm (vertical) x 600 mm</li> <li>• Foldable Grab Bars/ Swing Bars- 300 mm to 350 mm from the center line</li> </ul>
4	Toilet Roll Dispenser and Hand Water Faucet	<ul style="list-style-type: none"> <li>• Below the grab bars and not more than 300 mm from the front edge of the seat and at a height between 50 mm and 200 mm from the top of the water closet seat.</li> </ul>



S.NO.	FEATURE	RECOMMENDATIONS
<b>E.</b>	<b>WC – Indian style and related fixtures</b>	
1	Location	<ul style="list-style-type: none"> <li>• Floor mounted</li> </ul>
2	Type and Fixation levels	<ul style="list-style-type: none"> <li>• Indian Squat type</li> <li>• Ground level fixed with reference to center line 450 mm to 480 mm</li> </ul>
3	Grab Bars	<ul style="list-style-type: none"> <li>• Fixed Grab Bar L – Type – 750mm (vertical) x 600 mm</li> <li>• Refer to Fig: 4.37, 4.38, 4.39</li> </ul>
4	Toilet Roll Dispenser and Hand Water Faucet	<ul style="list-style-type: none"> <li>• Ablution tap at 200 mm and attached jet spray upto the height 450 mm</li> </ul>
<b>F.</b>	<b>Shower Spaces and related fixtures</b>	
1	Space	<ul style="list-style-type: none"> <li>• Varied spatial typology as enclosed space or space with tile drop line and color contrast</li> </ul>
2	Shower seat	<ul style="list-style-type: none"> <li>• Distance from Wall to Centre line of shower seat – 450 mm to 480 mm</li> </ul>
3	Faucet	<ul style="list-style-type: none"> <li>• Range of 750 mm to 800 mm</li> </ul>
4	Grab Bars	<p><b>Fixed Type (Vertical)</b></p> <ul style="list-style-type: none"> <li>• To be fixed at a height of 800 mm with a length of 600 mm</li> </ul> <p><b>Fixed Type (Horizontal)</b></p> <ul style="list-style-type: none"> <li>• To be fixed at a height of 800 mm with a length of 600 mm</li> </ul> <p><b>Foldable Type</b></p> <ul style="list-style-type: none"> <li>• To be fixed at 300 mm to 350 mm from the center line of shower seat and at a height of 800 mm</li> </ul>
5	Soap Dish / Niche	<ul style="list-style-type: none"> <li>• Positioned such that the operable parts and controls are between 800 mm and 1000 mm from the floor.</li> </ul>
<b>G.</b>	<b>Urinals</b>	
1	Space	<ul style="list-style-type: none"> <li>• 900 mm x 1200 mm</li> </ul>
2	Height	<ul style="list-style-type: none"> <li>• 500 mm</li> <li>• 380 mm (wheelchair accessible and child friendly)</li> </ul>
3	Grab Bars	<p><b>Fixed Type (Vertical)</b></p> <ul style="list-style-type: none"> <li>• To be fixed at a height of 800 mm with a length of 600 mm.</li> </ul> <p><b>Fixed Type (Horizontal)</b></p> <ul style="list-style-type: none"> <li>• To be fixed at a height of 800 mm with a length of 600 mm.</li> </ul> <p><b>Foldable Type</b></p> <ul style="list-style-type: none"> <li>• To be fixed at 300 mm to 350 from the center line of shower seat and at a height of 800 mm</li> </ul>

S.NO.	FEATURE	RECOMMENDATIONS
<b>H</b>	<b>Child Friendly Features</b>	
	Basin	The height of the wash basin should be at about 550 mm from the finished floor level.
	Baby Changing Station	<ul style="list-style-type: none"> <li>• Mounting Height : 700 mm to 800 mm</li> <li>• To be installed in both male and female washrooms including the unisex accessible / family friendly washroom</li> </ul>
	Baby Protection Seat	<ul style="list-style-type: none"> <li>• 400 mm from the finished floor level</li> </ul>
<b>I</b>	<b>Emergency Features</b>	
	Emergency Alarm Switch	<ul style="list-style-type: none"> <li>• Location : at a range of 700mm to 900 mm in reference with the L shaped grab bar</li> <li>• Colour: Contrasting colour, preferably red</li> </ul>
	Pull Cord	<ul style="list-style-type: none"> <li>• Coloured red, with two red bangles of 50 mm diameter, one set at a height between 800 mm and 1100 mm and the other set at 100 mm above floor level.</li> </ul>
<b>J</b>	<b>Changing Rooms</b>	
	Door Type	<ul style="list-style-type: none"> <li>• Door width of 900 mm minimum</li> </ul>
	Space	<ul style="list-style-type: none"> <li>• Preferably 1200 mm x 2100 mm</li> </ul>
<b>K</b>	<b>Miscellaneous Elements</b>	
	Cloth Hooks	<ul style="list-style-type: none"> <li>• 900 mm to 1200 mm</li> </ul>
	Switch heights	<ul style="list-style-type: none"> <li>• 1200 mm from the floor level</li> </ul>
	Vending machine for Sanitary napkins and diapers	<ul style="list-style-type: none"> <li>• Upto 1200 mm</li> </ul>

#### 4.9.1 General

1. Every washroom or public toilet complex shall ensure accessibility provisions for all disability and gender types. This essentially means making adequate space provisions like for maneuvering wheelchairs, baby prams or other assistive devices, provision of supportive features like grab rails, lever type handles, etc and well maintained & hygienic environment.
2. Provision of accessible information through multi-format information systems shall remain an integral feature for universally accessible washrooms.

3. Ideally in a public toilet environment accessible WC cubicles shall be present in both male and female washrooms. Wherever, it is challenging to make such provisions, a gender neutral/unisex accessible washroom shall be provided with all supportive features including lateral transfer provisions to WC.
4. An all-inclusive and universally accessible washroom system shall ensure provisions for diverse cultural choices as well. This implies provision of **25% Indian style WC cubicles** in public toilet environment.
5. Certain spaces or built environment typologies like shopping malls, transportation hubs, etc shall also require to create family friendly washrooms along with baby changing facilities and baby feeding room. Where there is requirement for only one toilet or sanitary room in a building, a wheelchair accessible unisex/gender neutral toilet shall be provided but of a greater width to accommodate a standing height washbasin and a urinal.
6. The provision of the accessible toilets shall be such that any wheelchair user/ambulant disabled person doesn't have to travel more than 30 m on the same floor.
7. The design of toilet facilities shall incorporate ease of use for all people and location of fittings should follow a logical sequence.
8. Care shall be taken in placing mirrors and lights to avoid confusion and dazzling for visually impaired users.

#### 4.9.2 Public Toilets

Wherever there is provision of public washrooms to be used by employees, staff, students, patients, or other intended users, they all should be accessible to be

used by users of different ages, gender and persons with disabilities who may be independent, accompanied or assisted. Conventionally, public toilets consist of separate toilet facilities for female and male users. They either come in a cluster layout which has multiple WC cubicles and wash basins provided for larger establishments. Public washroom designs have seen an evolution in their typologies which pays emphasis on diverse human needs such as persons with disabilities, transgenders, elders with caregivers, families with younger children and expectant mothers. In all public toilets, the following shall be provided:

1. Male section shall have at least one urinal with support grab bars for ambulant disabled and at least one urinal for children at a lower height.
2. Both male and female section shall have one WC for ambulant disabled
3. Depending on footfall, one accessible toilet in both male and female toilet groups or one unisex/gender neutral accessible toilet room with independent entrance shall be provided.
4. It needs to be ensured that accessibility services including emergency services along with sanitation and hygienic services are well integrated & maintained in the public toilet system.

#### 4.9.3 Family Friendly Washrooms

Family washrooms are provided in facilities which host several families on a regular basis like - shopping malls, cinema theatres, airports, railway stations, etc. Apart from hosting families with younger children, this facility is also very convenient to be used by older family members who require assistance from caregivers, expectant mothers,



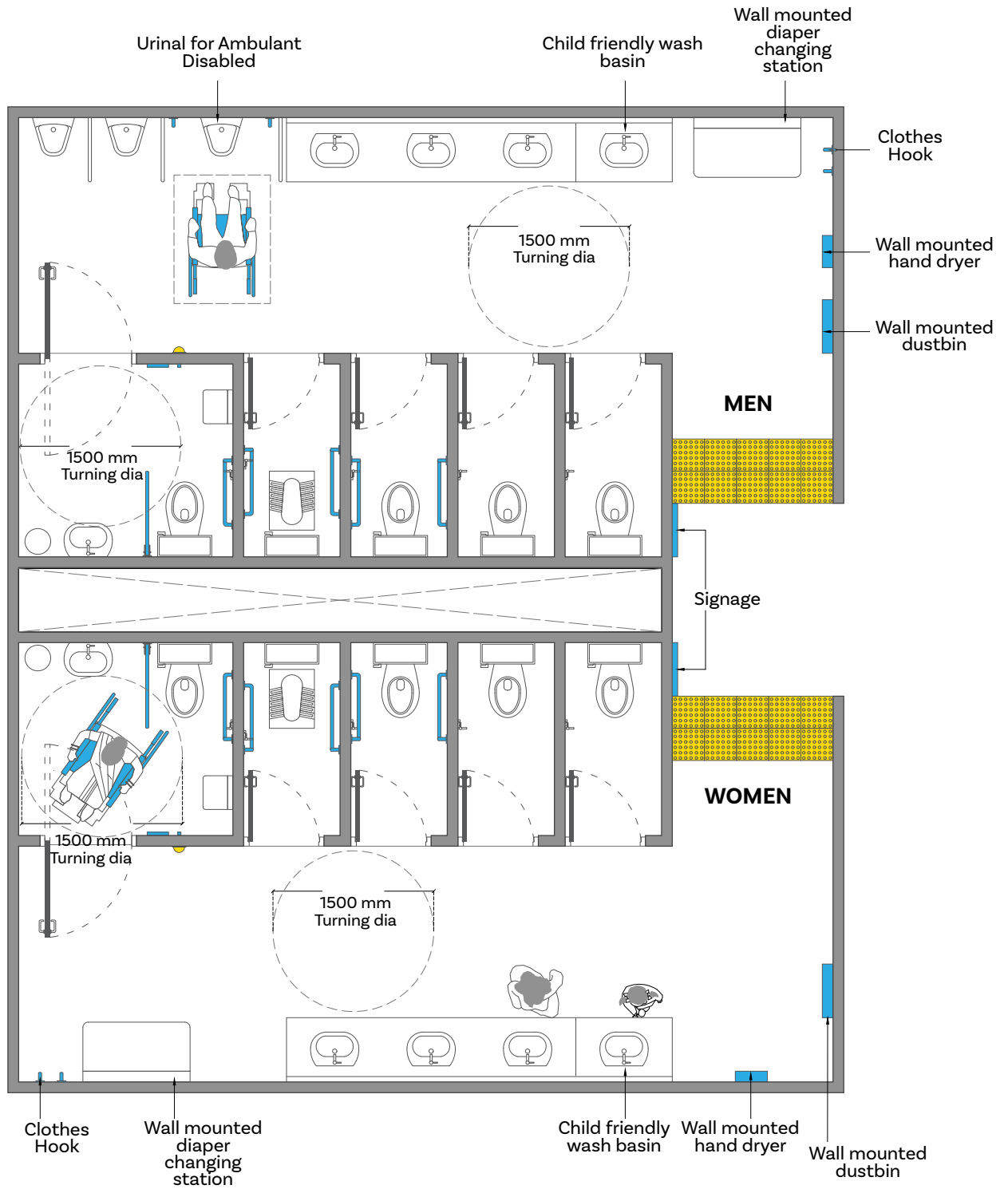


Figure 4.22 Accessible public toilet layout: Type A

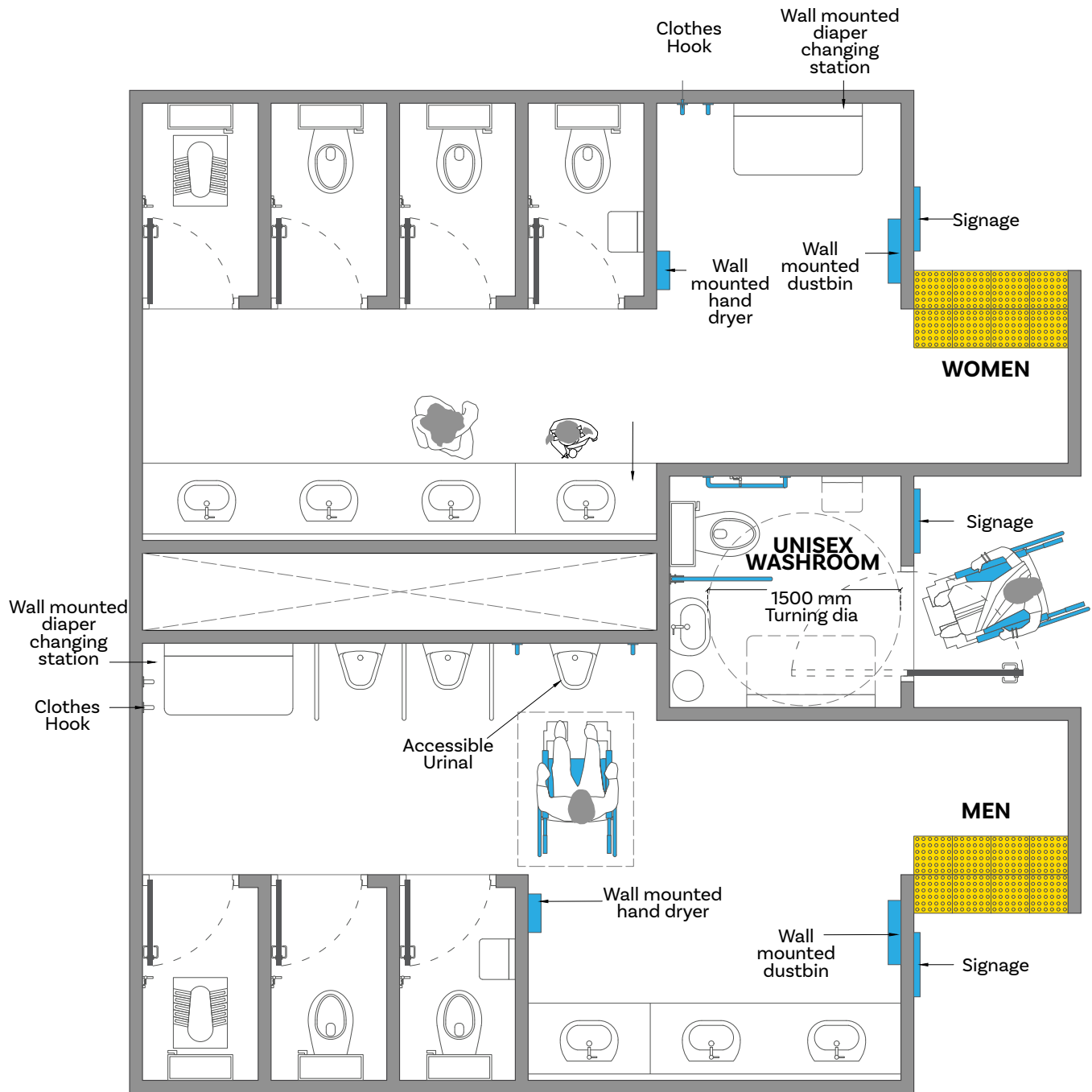


Figure 4.23 Accessible public toilet layout: Type B

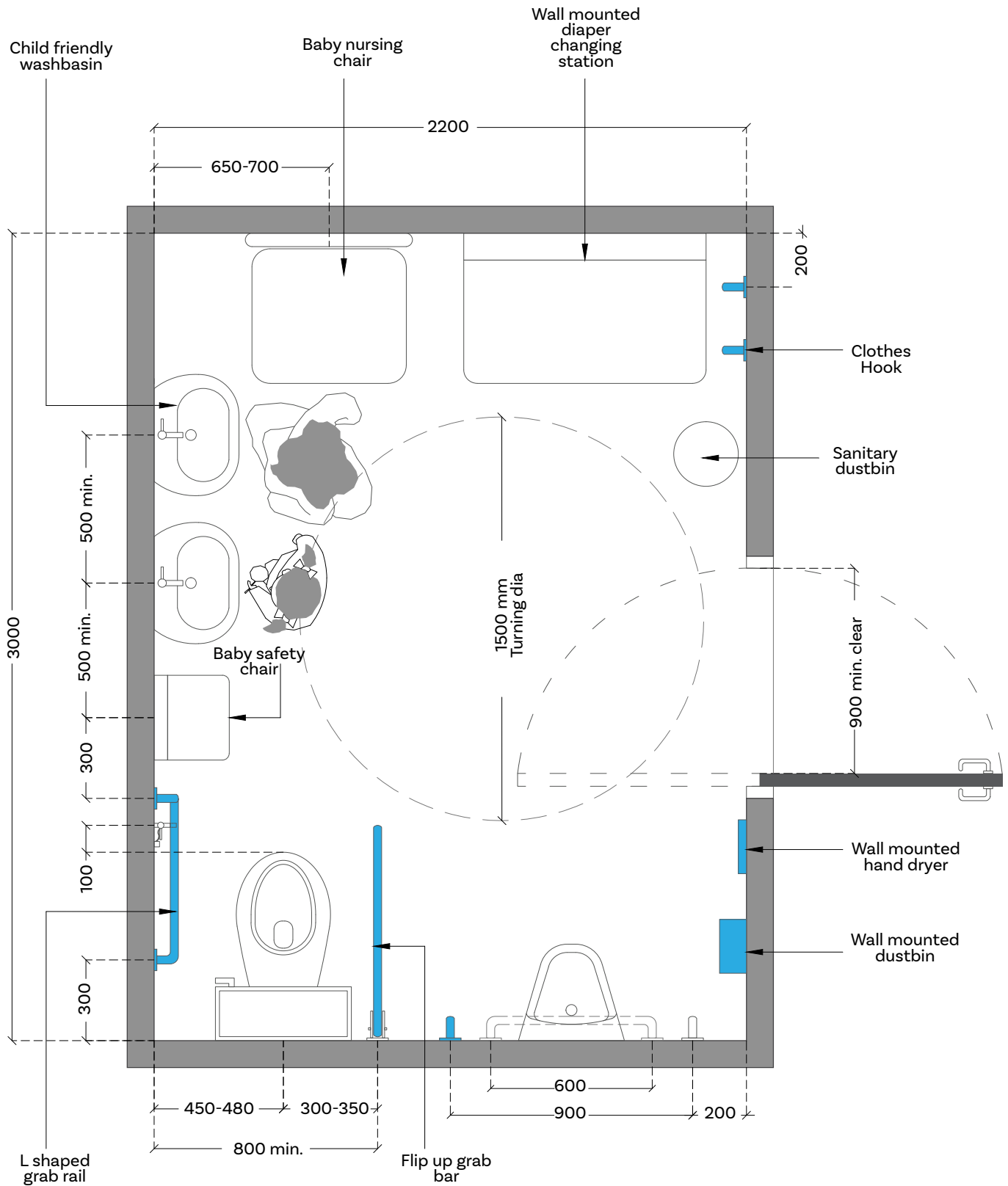


Figure 4.24 Family Toilet detail





Image 4.14 Accessible Unisex/Gender neutral washroom  
Photo Credits: Dr. Gaurav Raheja







Image 4.15 Vending Machine for sanitary napkins  
Photo Credits: Shreya Shetty

people recovering from physical injuries who may require assistance from a family member or a caregiver while using washroom facilities. Family washrooms mostly consist of WC, urinal, wash basin facilities for adults and children, diaper changing station, child protection seat, and provision of seat for Nursing mothers.

1. A family washroom will benefit a wide range of users, including parents attending to their infants, and young children who need assistance with their toilet activities.
2. The family washroom should be equipped with:
  - a. A wash basin with liquid detergent and paper towels.
  - b. A child-sized water closet and wash basin.
  - c. Mirrors.
  - d. A diaper changing station.
  - e. A child protection seat.
  - f. A vending machine for sanitary napkins and diapers.

g. Space for baby carriage parking

#### 4.9.4 Unisex Accessible Toilets (multi-use)

Unisex or gender-inclusive accessible toilet allows Persons with Disabilities to be assisted by carers of the same or opposite gender. In all public buildings, one unisex or gender-inclusive accessible toilet should be provided in each toilet block on each floor. Apart from this all-toilet blocks must have one cubicle suitable for use by persons with ambulatory disabilities.

The unisex toilet should have: -

1. Minimum internal dimensions of 2200mm x 2000mm (refer Fig. 4.25 & Fig. 4.26)
2. It is recommended to have a clear manoeuvring space of 1800mm diameter in front of the water closet and wash basin in the accessible toilet unit and the layout of the fixtures in



people recovering from physical injuries who may require assistance from a family member or a caregiver while using washroom facilities. Family washrooms mostly consist of WC, urinal, wash basin facilities for adults and children, diaper changing station, child protection seat, and provision of seat for Nursing mothers.

1. A family washroom will benefit a wide range of users, including parents attending to their infants, and young children who need assistance with their toilet activities.
2. The family washroom should be equipped with:
  - a. A wash basin with liquid detergent and paper towels.
  - b. A child-sized water closet and wash basin.
  - c. Mirrors.

d. A diaper changing station.

e. A child protection seat.

f. A vending machine for sanitary napkins and diapers.

g. Space for baby carriage parking

#### 4.9.4 Unisex Accessible Toilets (multi-use)

Unisex or gender-inclusive accessible toilet allows Persons with Disabilities to be assisted by carers of the same or opposite gender. In all public buildings, one unisex or gender-inclusive accessible toilet should be provided in each toilet block on each floor. Apart from this all-toilet blocks must have one cubicle suitable for use by persons with ambulatory disabilities.



Image 4.16 Accessible gender neutral washroom  
Photo Credits: Dr. Gaurav Raheja

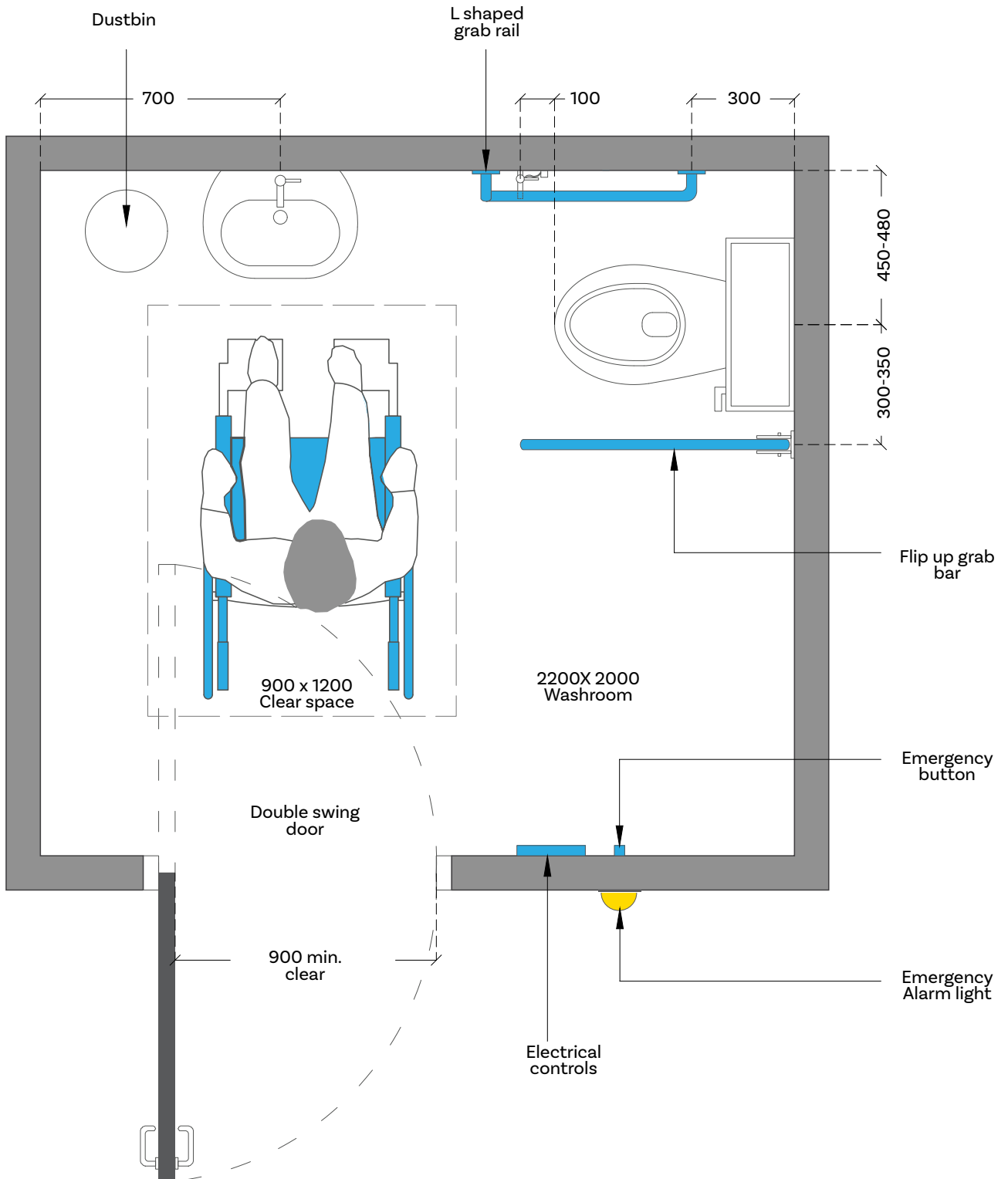


Figure 4.25 Detail of accessible washroom with double swing door: Plan

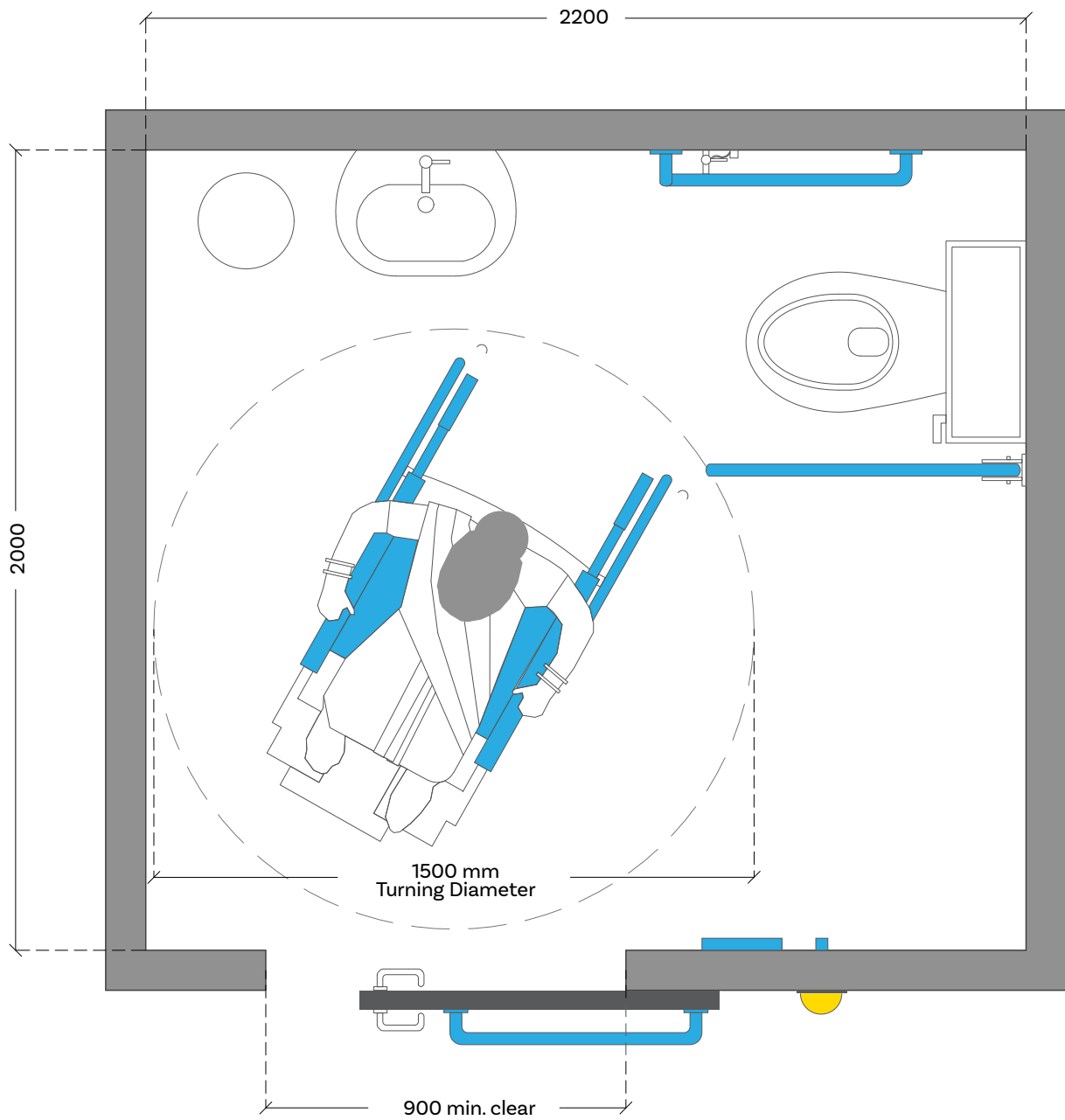


Figure 4.26 Detail of accessible washroom with sliding door: Plan



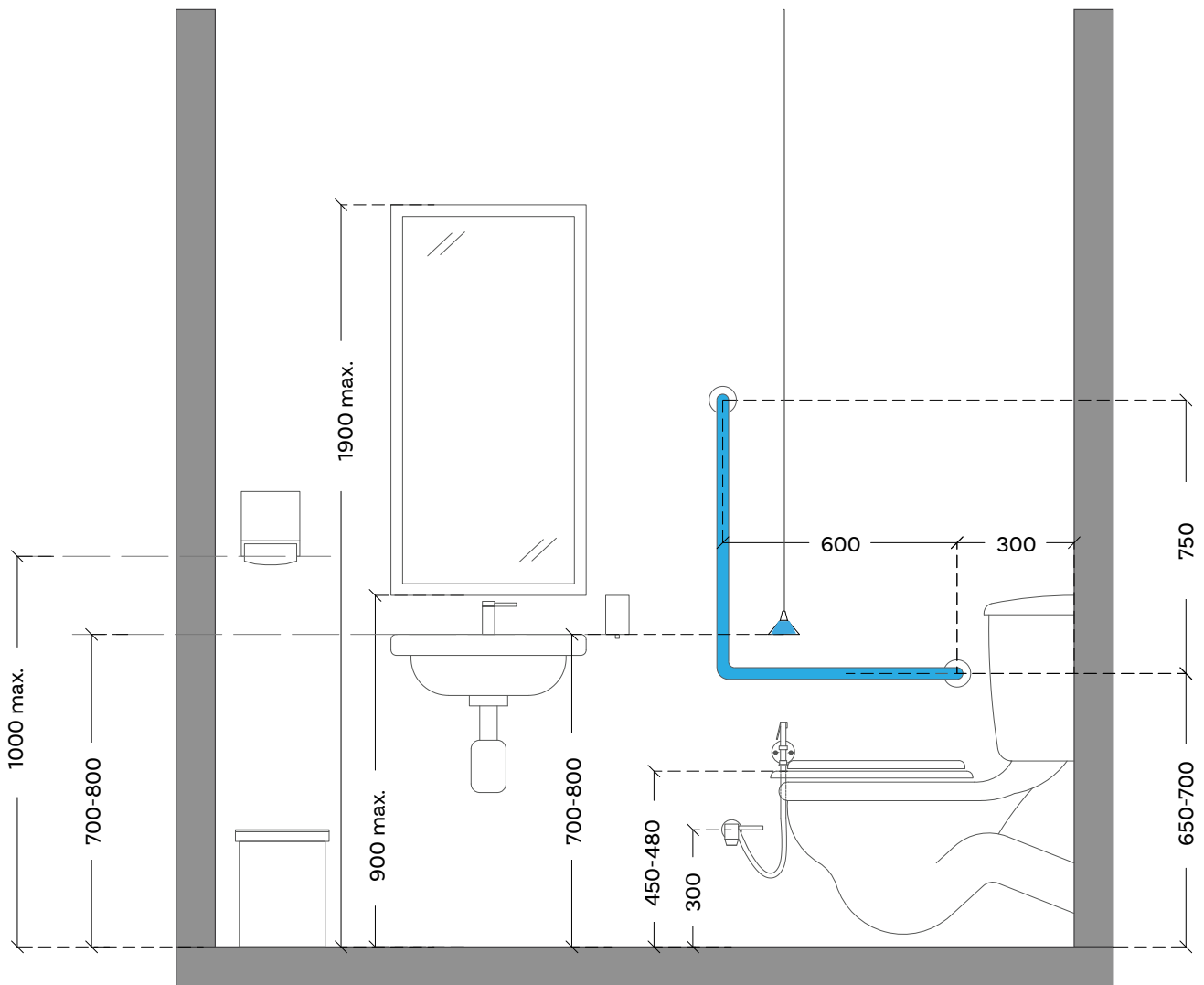


Figure 4.27 Detail of accessible washroom: Sectional elevation

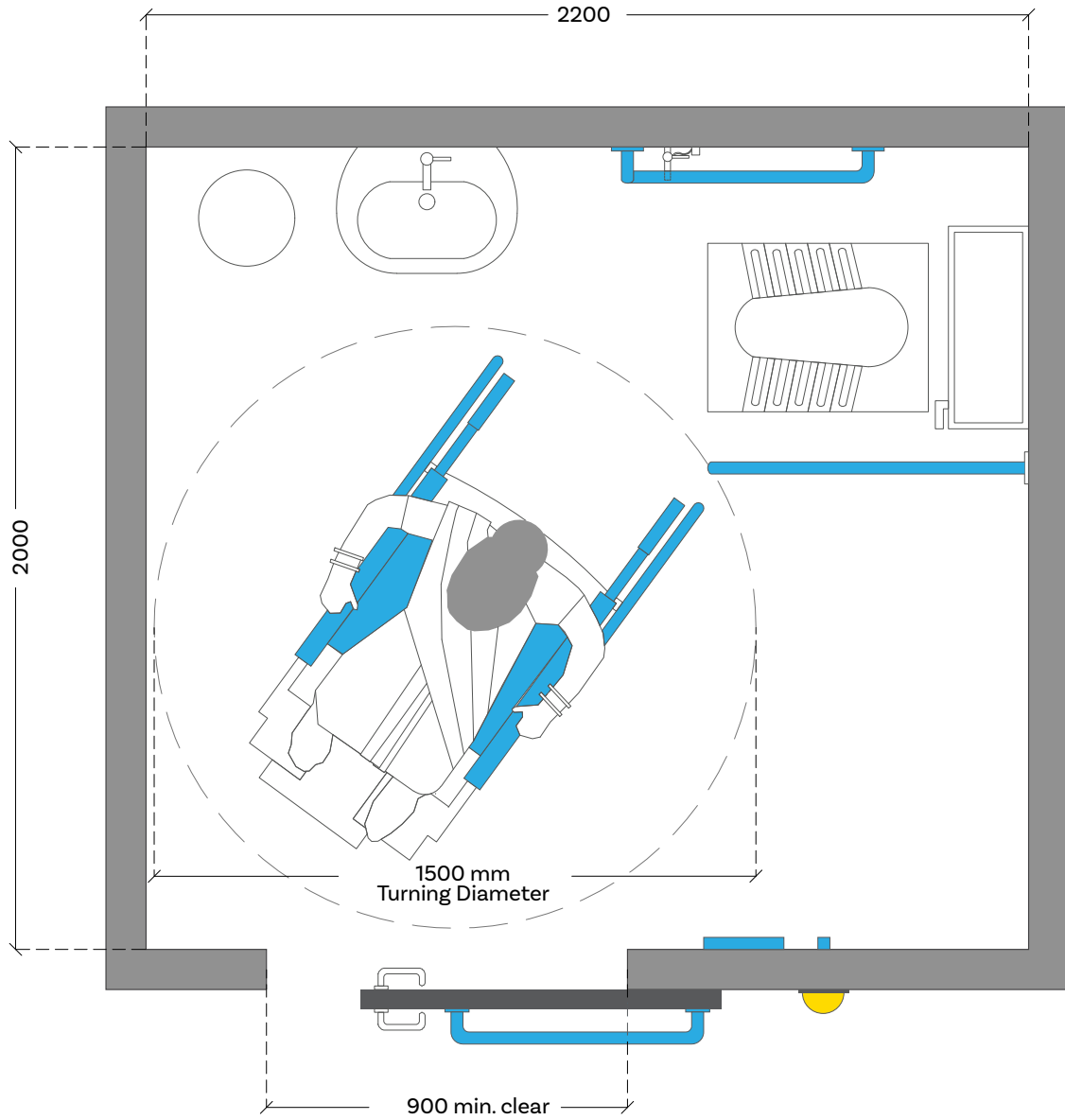


Figure 4.28 Detail of accessible Indian washroom with sliding door: Plan layout



Image 4.17 Accessible Washroom  
Photo Credits: Dr. Gaurav Raheja





VIDA

請勿使用  
請勿使用

請勿使用  
請勿使用

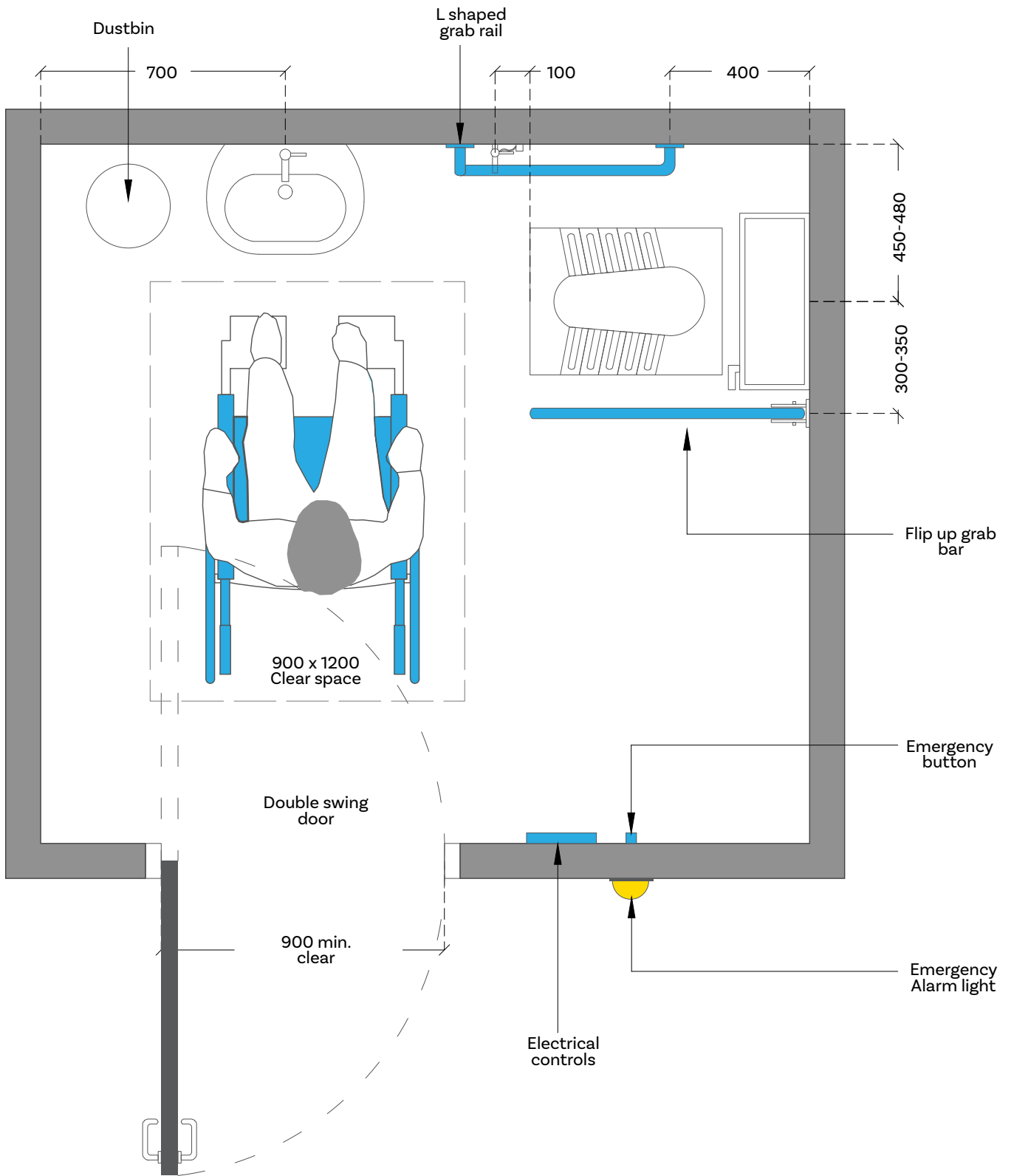


Figure 4.29 Detail of accessible Indian washroom with double swing door: Plan layout

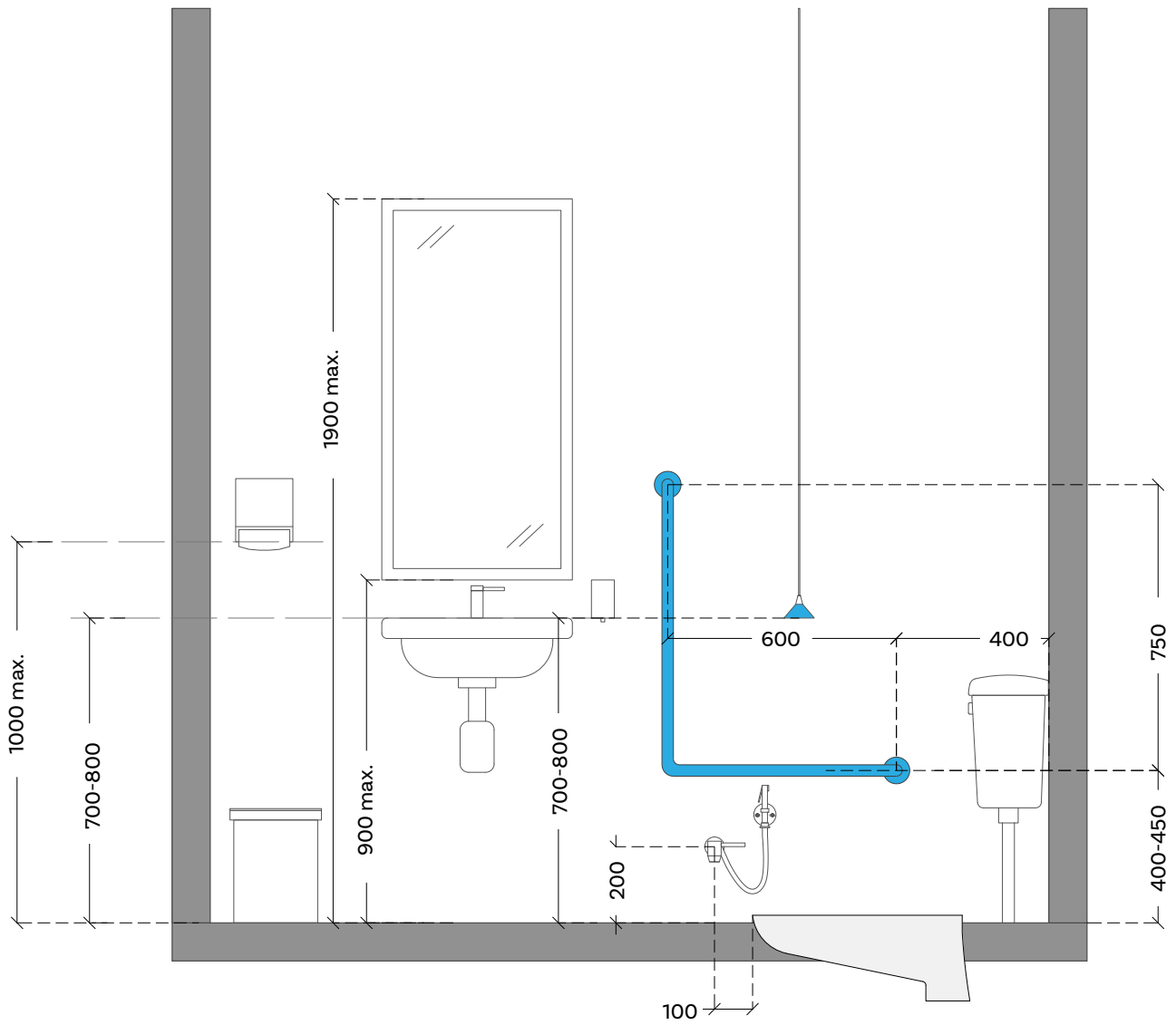


Figure 4.30 Detail of accessible Indian washroom: Sectional elevation



## Chapter 4: Internal Elements

The unisex toilet should have: -

1. Minimum internal dimensions of 2200mm x 2000mm (refer Fig. 4.25 & Fig. 4.26)
2. It is recommended to have a clear manoeuvring space of 1800mm diameter in front of the water closet and wash basin in the accessible toilet unit and the layout of the fixtures in the toilet should be arranged to facilitate this clear space. If the above mentioned space is not available, an uncompromising space of 1500mm diameter shall be provided. The layout of the fixtures in the toilet should be as mentioned below -
  - a. All fixtures and utilities should provide a clear space of 900mm x 1200 mm for wheelchair users to access them
  - b. Have clear space of not less than 900 mm wide next to the water closet
  - c. Be equipped with a door complying with Section 4.9.5
  - d. Have a water closet complying with Section 4.9.6
  - e. Have grab bars complying with Section 4.6.7
  - f. Have a wash basin complying with Section 4.9.8
  - g. Have essential washroom accessories complying with Section 4.9.9
  - h. Have the toilet roll dispenser and hand water faucet mounted below the grab bars and at not more than 300 mm from the front edge of the seat and at a height between 50 mm and 200 mm from the top of the water closet seat
  - i. Be equipped with a cloth hooks mounted on a side wall not more than 1200 mm from the floor and projecting not more than 40 mm from the wall
  - j. Where possible, be equipped with a shelf of dimensions 400 mm



Image 4.18 Accessible Toilet  
Photo Credits: Dr. Gaurav Raheja

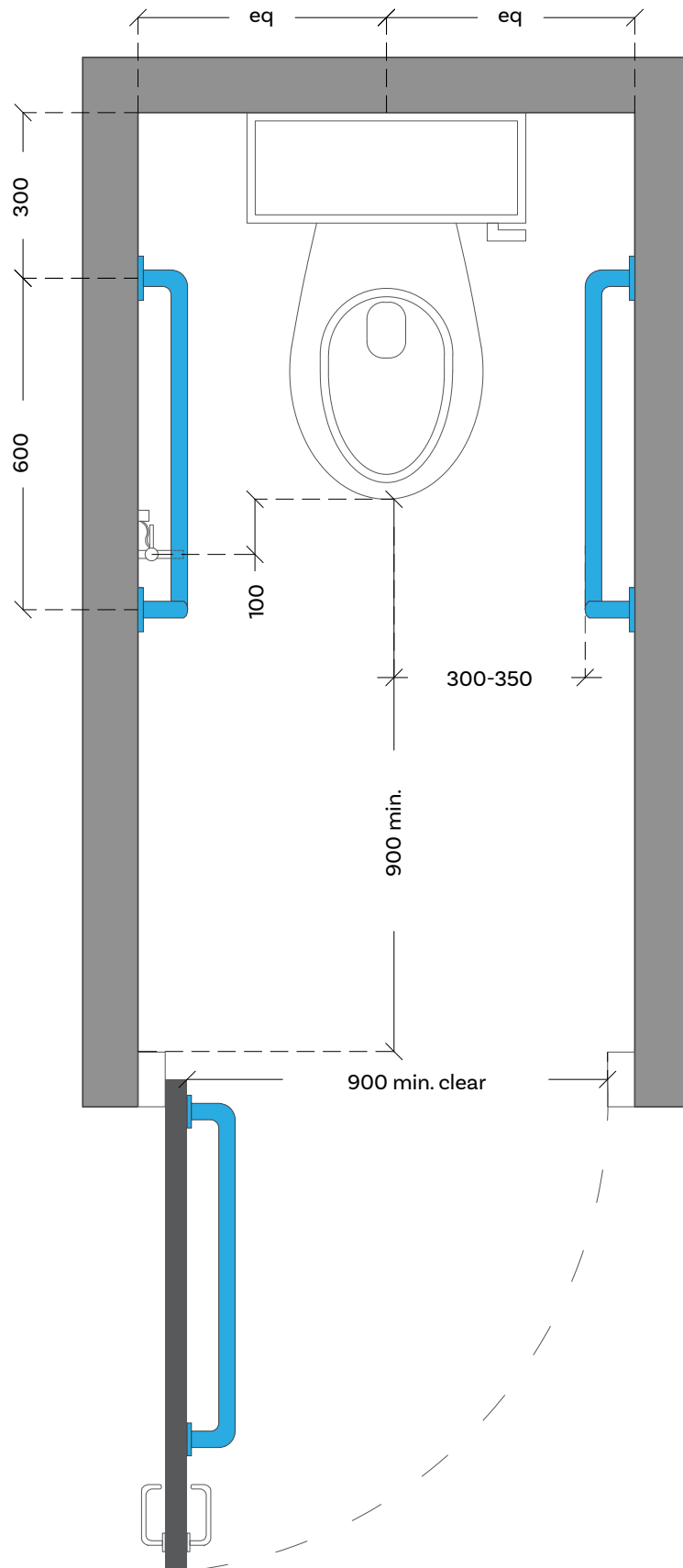


Figure 4.31 Ambulant Toilet detail: Plan Layout

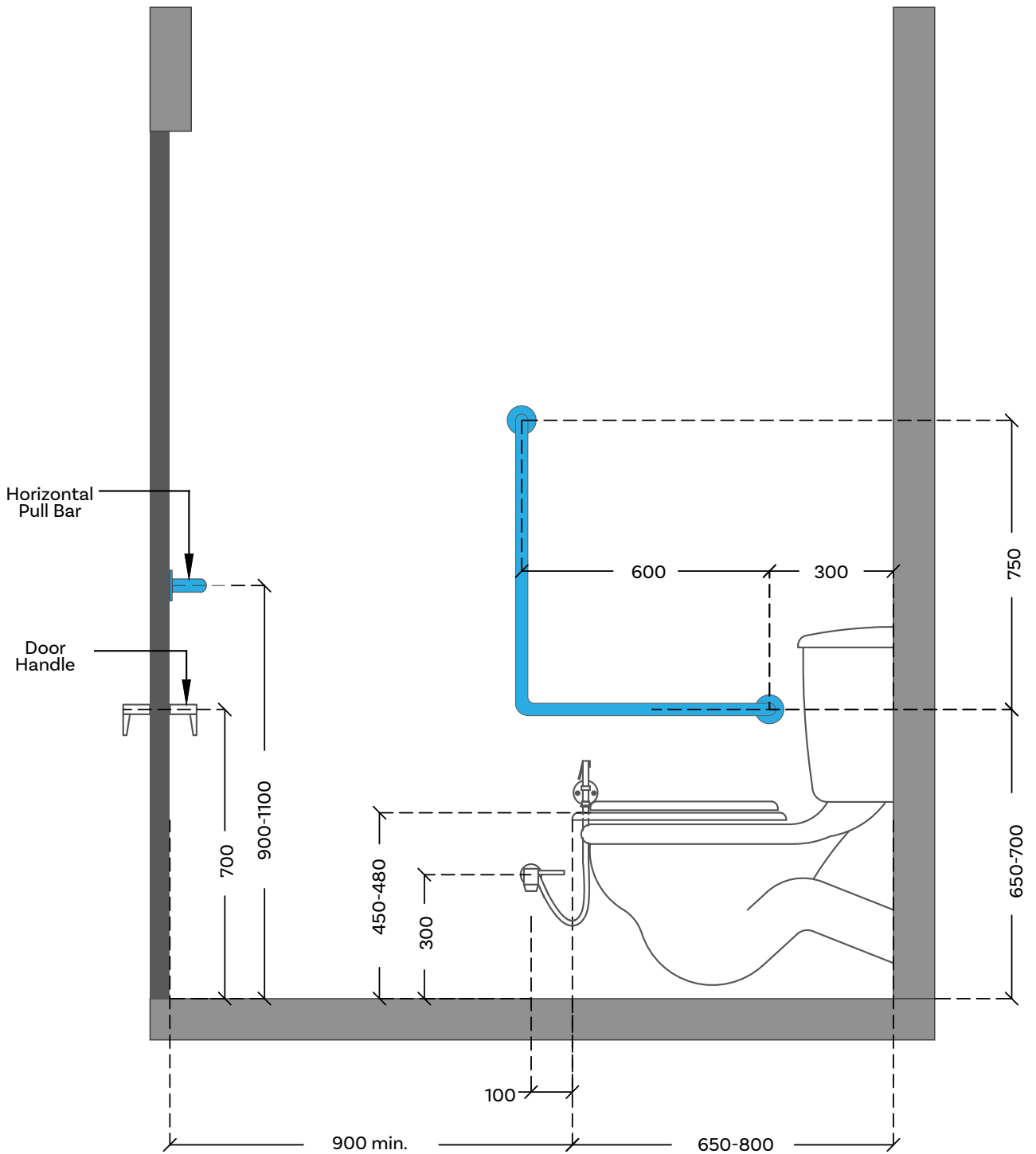


Figure 4.32 Ambulant Toilet detail: Sectional elevation



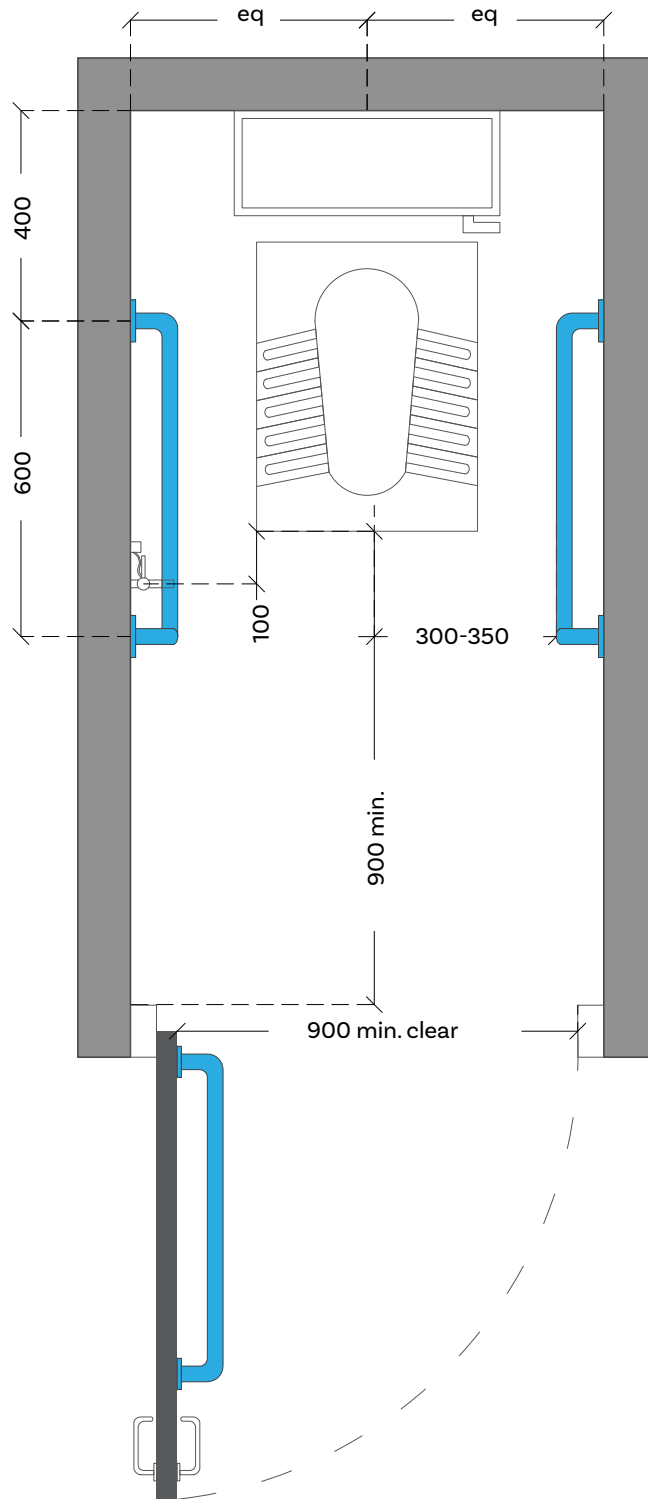


Figure 4.33 Ambulant Indian Toilet detail: Plan layout

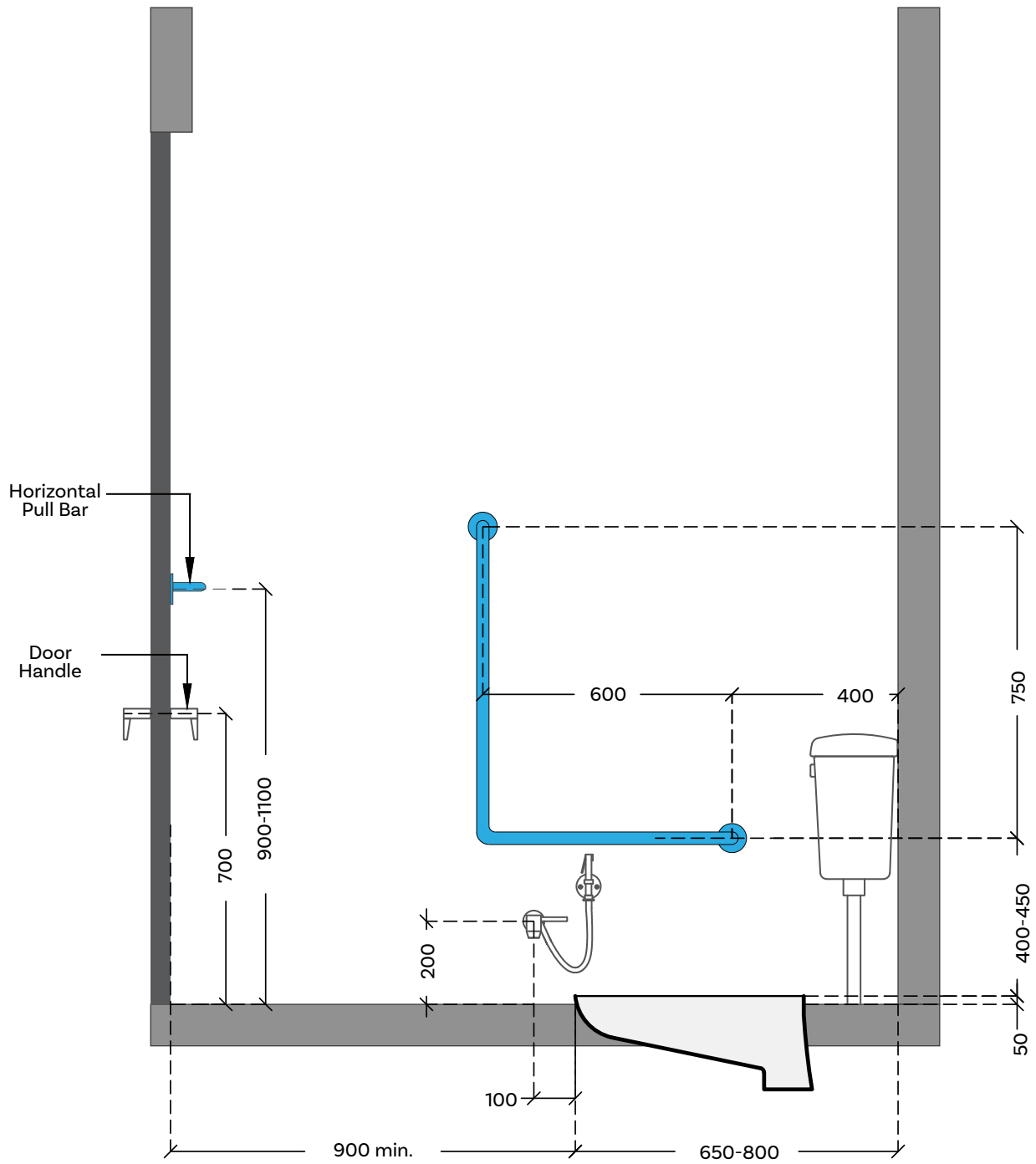


Figure 4.34 Ambulant Indian Toilet detail: Sectional elevation type A

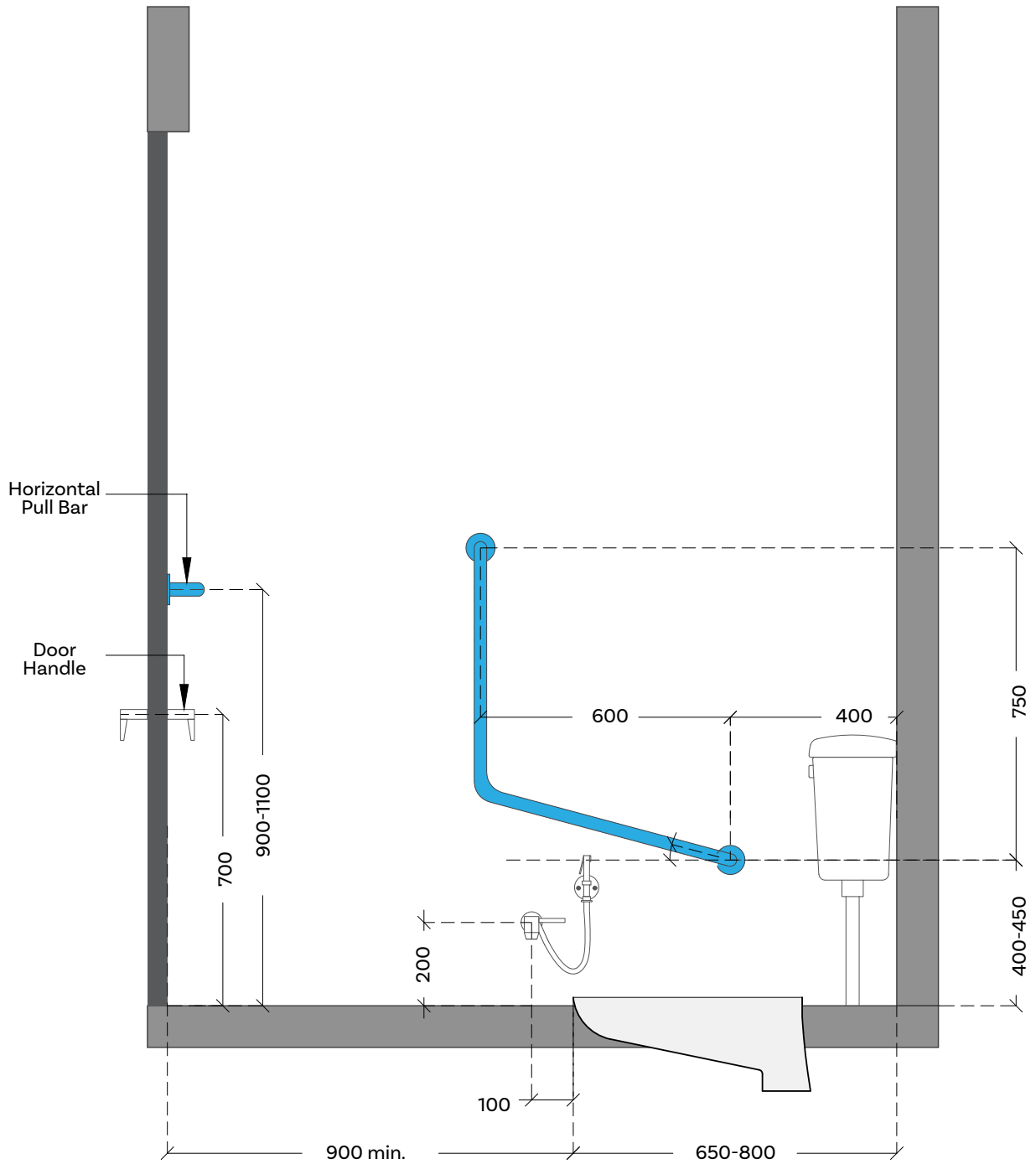


Figure 4.35 Ambulant Indian Toilet detail: Sectional elevation type B



## Chapter 4: Internal Elements

x 200 mm fixed at a height of between 900 mm and 1000 mm from the floor.

### 4.9.5 Toilet Doors

Essential requirements for toilet door:

1. The toilet door should be either an outward opening door or two-way opening door or a sliding type and should provide a clear opening width of at least 900 mm.
2. Be provided with a horizontal pull-bar, at least 600 mm long, on the inside of the door, located so that it is 130 mm from the hinged side of the door and at a height of 1000 mm.
3. Be capable of being locked from the inside by a device that is operable

by one hand, activated by a force not more than 22N and which does not require fine finger control, tight grasping, pinching, or twisting of the wrist.

4. It is not recommended to provide a doorknob for locking and operating mechanisms.
5. For added security, each stall should have a visual lock that displays occupancy.
6. Other door related fixtures/hardware can be placed in accordance to Section 4.10.8.

### 4.9.6 Water Closet (WC)

1. Be located between 460 mm to 480 mm from the centreline of the



Image 4.19 Grab bars in the Accessible Washroom  
Photo Credits: Dr. Gaurav Raheja



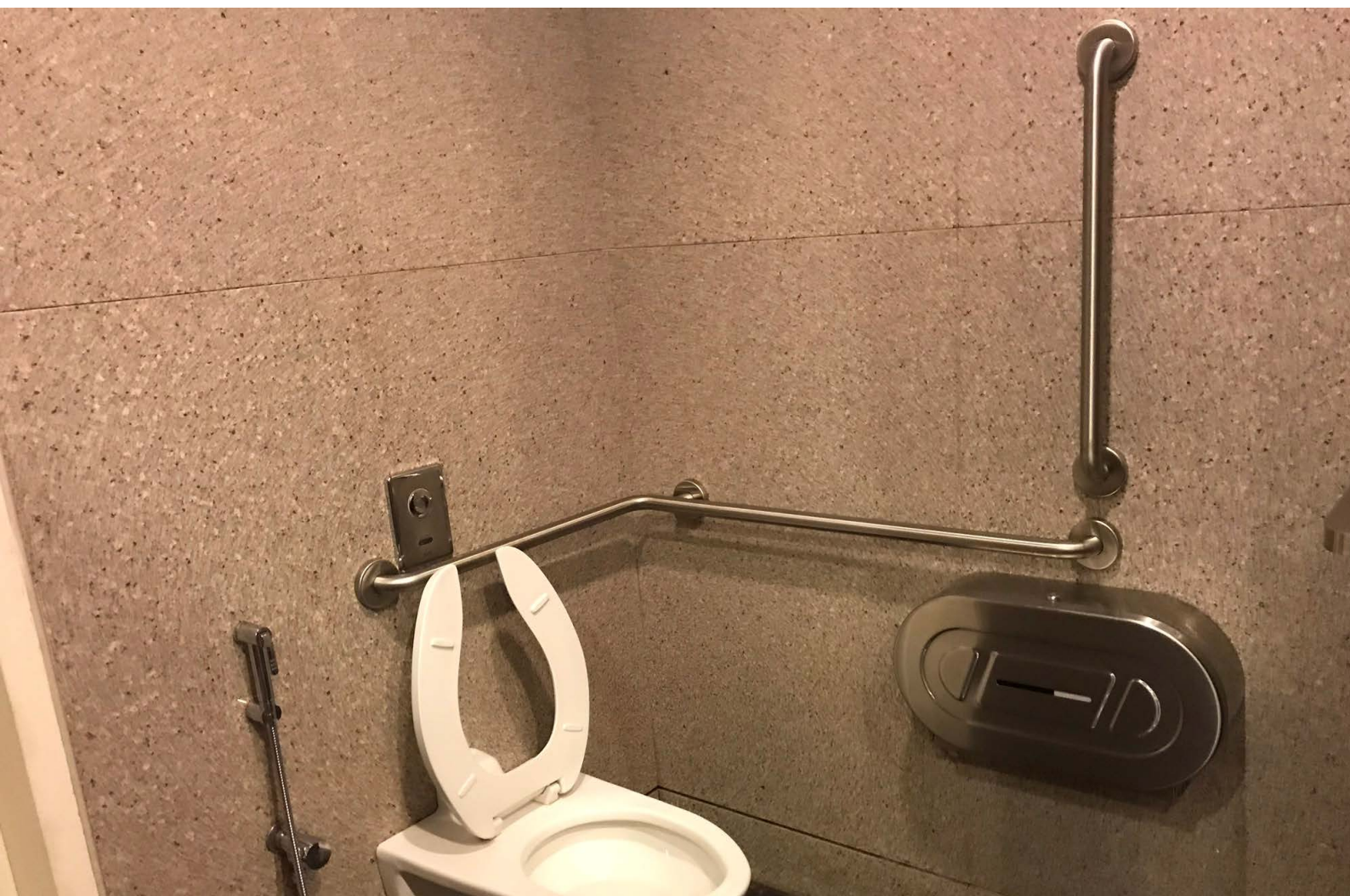


Image 4.20 Accessible Washroom  
Photo Credits: Dr. Gaurav Raheja

water closet to the adjacent wall.

2. It should have a clear dimension of 750 mm from the front edge of the water closet to the rear wall to facilitate side transfer.
3. The top of the water closet seat should be 450 to 480 mm from the floor; when the water closet does not have the required height, the necessary height may be obtained by providing a circular base under the water closet. The base so provided must not protrude beyond the circumference of the base of the water closet.
4. There should be an adequate clear floor space of at least 1350 mm depth and 900 mm width, both in front and on the transfer side, adjacent to the water closet.
5. Have a suitable back support to reduce the chance of imbalance or injury caused by leaning against exposed valves or pipes.
6. Preferably be of wall-hung or corbel type as it provides additional space at the toe level.
7. Where water cistern is used, the cover should be securely attached.
8. The Flush control should either be lever type or automatic and located on the transfer side of the water closet. The flush control should not be located more than 1000 mm from the floor.
9. Where more than one accessible toilet is provided, a left- and right-hand transfer option should be made available.

#### **4.9.7 Grab Bars**

1. Water closets should be provided with grab bars, be mounted at a height between 200 mm and 250 mm from the water closet seat

2. One L-shape grab bar: 600mm long horizontal and 750mm (Refer Fig. 4.25) long vertical should be mounted on the side wall closest to the water closet
3. A hinged type of horizontal grab bar or a flip up grab bar should be installed adjacent to the water closet; at 320mm from the centreline of the WC, between heights of 200 mm - 250 mm from the top of the water closet seat and extending 100 mm to 150 mm beyond the front of the water closet.
4. The horizontal grab bar shall be uninterrupted for its full length.
5. The positioning of accessories such as hand towel, soap, waste bin, etc, should not hamper the use of the grab bar.
6. The grab bar height for toilets for children should be between 510 mm and 635 mm.
7. An emergency alarm cum call switch should be provided within easy reach on the wall near the water closet at two levels: at 300mm and 900mm from the floor level to allow the user to call for help in case of an emergency.

#### **4.9.8 Washbasin**

A washbasin complying with following requirements shall be provided within an accessible toilet room:

1. It shall provide a minimum clear floor space of 900 mm wide by 1200 mm deep, of which a maximum of 480 mm in depth may be under the washbasin.
2. It shall be mounted such that the minimum distance between the centreline of the fixture and the sidewall is 460 mm; and the top edge of the wash basin is between 750 mm





Image 4.21 Accessible Washbasin  
Photo Credits: Dr. Gaurav Raheja

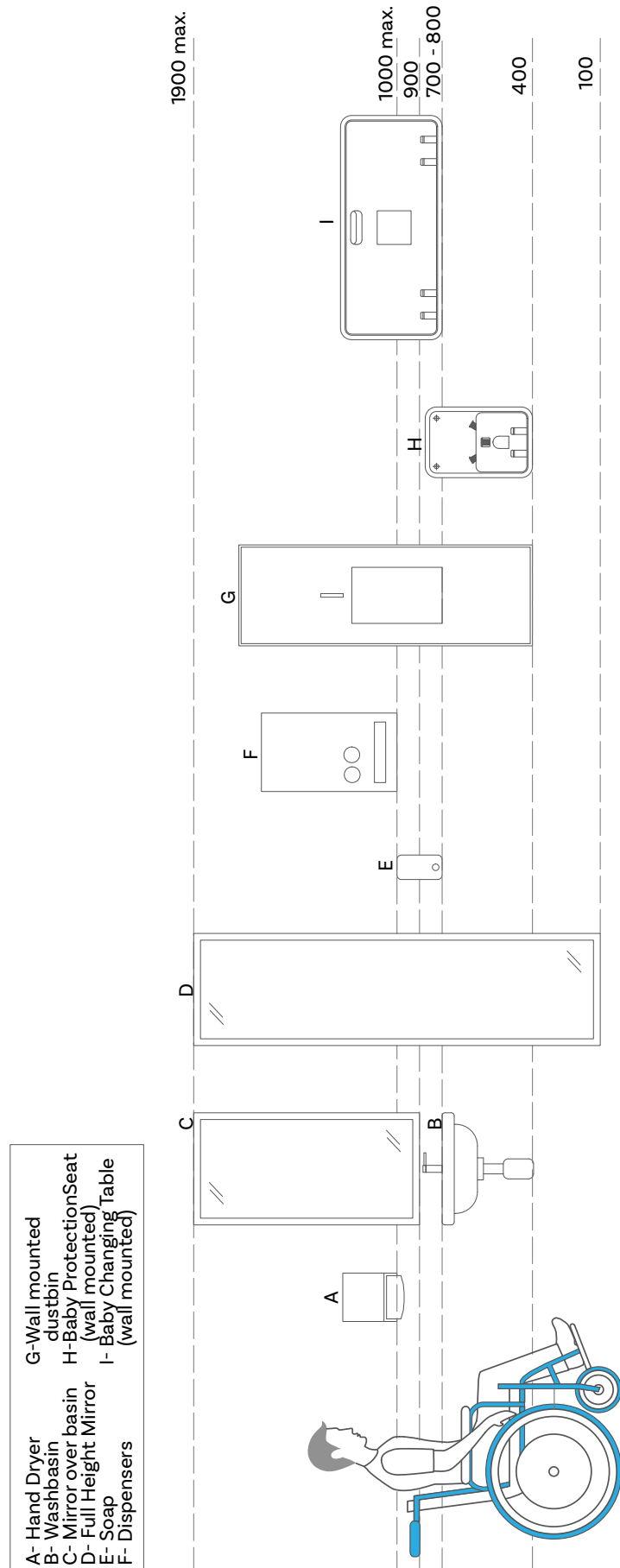


Figure 4.36 Detail of accessible washroom: Sectional elevation



and 850 mm from the floor.

3. The space under the washbasin shall be unobstructed with a knee clearance centred on the washbasin between 680 mm and 700 mm high, and 200 mm deep. In addition, a toe clearance of at least 230 mm high shall be provided.
4. The front edge of the washbasin shall be located within 350 mm to 600 mm from the wall.
5. Lever type or automatic/sensor type faucets are recommended for better

accessibility.

6. In front of the washbasin, space should allow for a frontal or oblique approach by a wheelchair. The reaching distance to the tap control shall be a maximum of 300 mm.

#### 4.9.9 Washroom Accessories

Washroom accessories should comprise the following:

1. A mirror installed in a way to have the bottom edge at a height of not more



Image 4.22 Accessible sensor based faucet  
Photo Credits: Dr. Gaurav Raheja



than 1000 mm from the floor and mirror should be tilted at an angle of 30° for better visibility of wheelchair user.

2. Towel and soap dispensers, hand dryer and waste bin positioned such that the operable parts and controls are between 800 mm and 1000 mm from the floor.
3. Accessories should be placed near the basin, to avoid a person with wet hands wheeling a chair.
4. Cloth hooks should be set at different heights, 900 mm to 1100 mm, and additionally at least one hook at 1400 mm.
5. Dispensers for toilet paper shall be reachable from the water-closet, either under the grab bar or on the side-wall of a corner toilet at a height between 600 mm and 700 mm from the floor.
6. If a sanitary bin is supplied, it should be reachable from the water-closet. Sanitary bins with non-touch opening devices are recommended.
7. Non-touch soap dispensers are recommended.

#### **4.9.10 Faucets/taps**

Faucets and other controls designated for use by Persons with Disabilities should be hand-operated or electronically controlled (sensor based). Hand-operated controls should:

1. Be operable by one hand.
2. Require no tight grasping, pinching, or twisting of the wrist.
3. Require a force less than 22 N to activate; and have handles of lever type (not self-closing) operable with a closed fist.
4. To cater to persons with visual

impairments controls should be colour-contrasted with the surrounding face plate panel and the faceplate should similarly contrast with the background wall on which it is mounted.

#### **4.9.11 Urinals**

1. At least one of the urinals in the Male toilets on each floor should have grab bars; installed on each side and in the front of the urinal to support ambulant Persons with ambulant disabilities, elderly and others with functional limitations.
2. The front bar is to provide chest support; the sidebars are for the user to hold on to while standing.
3. Urinals shall be stall-type or wall-hung, with an elongated rim at a maximum of 430 mm above the finish floor.
4. A clear floor space 760 mm by 1200 mm should be provided in front of urinals to allow forward approach. Urinal shields or screens (that do not extend beyond the front edge of the urinal rim) may be provided with 735 mm clearance between them
5. Flush controls should be located not more than 1200 mm from the floor.

#### **4.9.12 Emergency Warning Alarm**

Emergency alarms and warning systems need to adhere strictly to guidelines for them to be accessible to everyone. The integration of visual and audio features is highly recommended for these systems.

Visual emergency alarm can provide alert signals appropriately to persons with hearing impairments including deaf and others with situational conditions.

It needs to be ensured that emergency



Image 4.23 Accessible Urinals  
Photo Credits: Dr. Gaurav Raheja

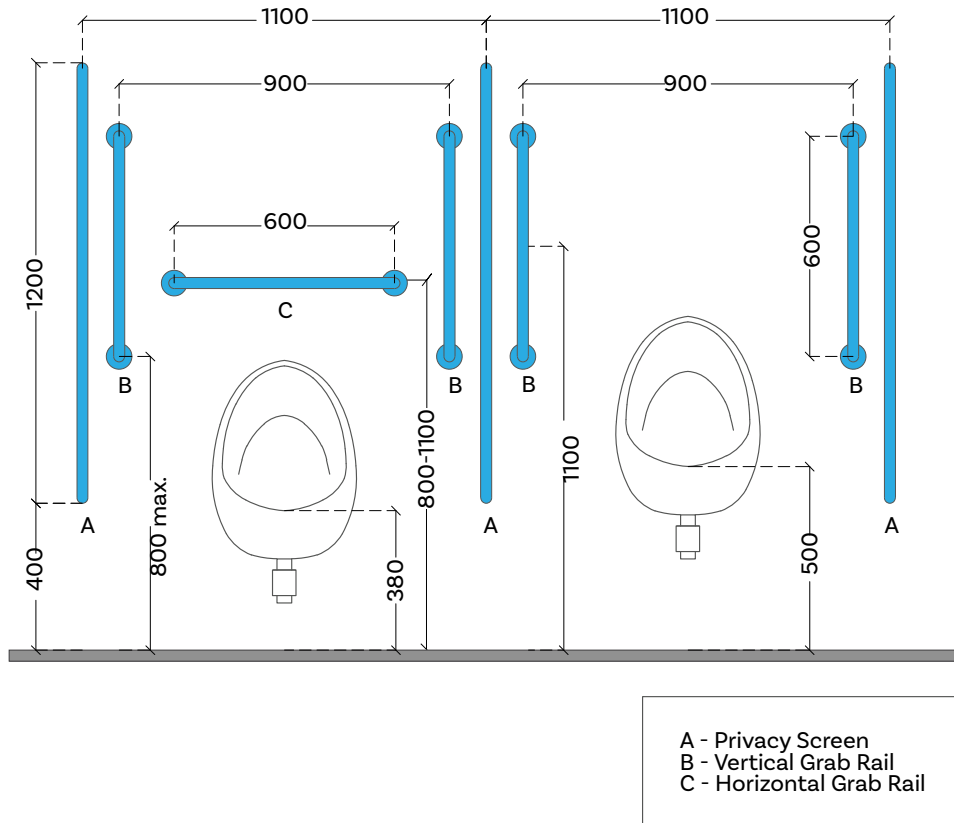


Fig a: Accessible urinal: Sectional elevation

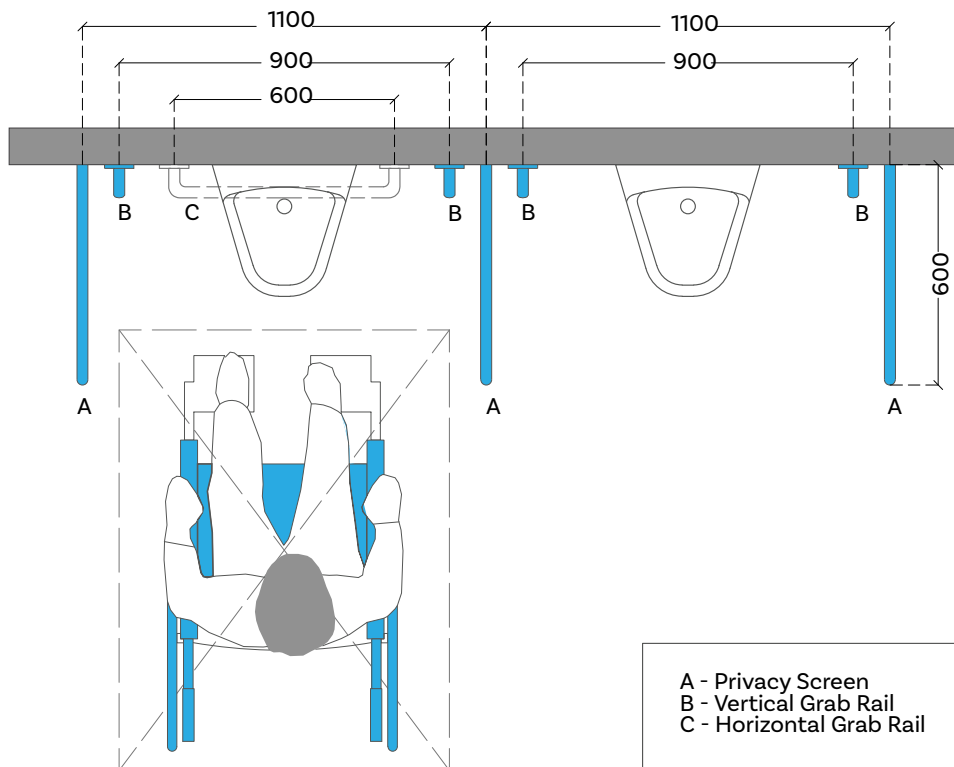


Fig b: Accessible urinal: Plan layout

Figure 4.37 Accessible Urinals





Image 4.24 Accessible Urinal with grab bar  
Photo Credits: Dr. Gaurav Raheja

alarm systems are well coordinated with emergency support services and provide immediate rescue and support mechanisms to persons in need.

#### 4.9.12.1 Alarm Systems

1. An assistance alarm, which can be reached from changing or shower seats, from the WC and by a person lying on the floor, shall be provided in all accessible toilets and accessible sanitary rooms. This alarm should be connected to an emergency help point, or where a member of staff can assist.
2. Visual and audible feedback should be provided to indicate that, when

the alarm has been operated, the emergency assistance call has been acknowledged and action has been taken.

3. It should take the form of a pull cord, coloured red, with two red bangles of 50 mm diameter, one set at a height between 800 mm and 1100 mm and the other set at 100 mm above floor level.
4. A reset control shall be provided for use if the alarm is activated by mistake. It shall be reachable from a wheelchair and, where relevant, from the WC, the tip-up seat in a shower or changing facility.
5. The reset control shall be easy to

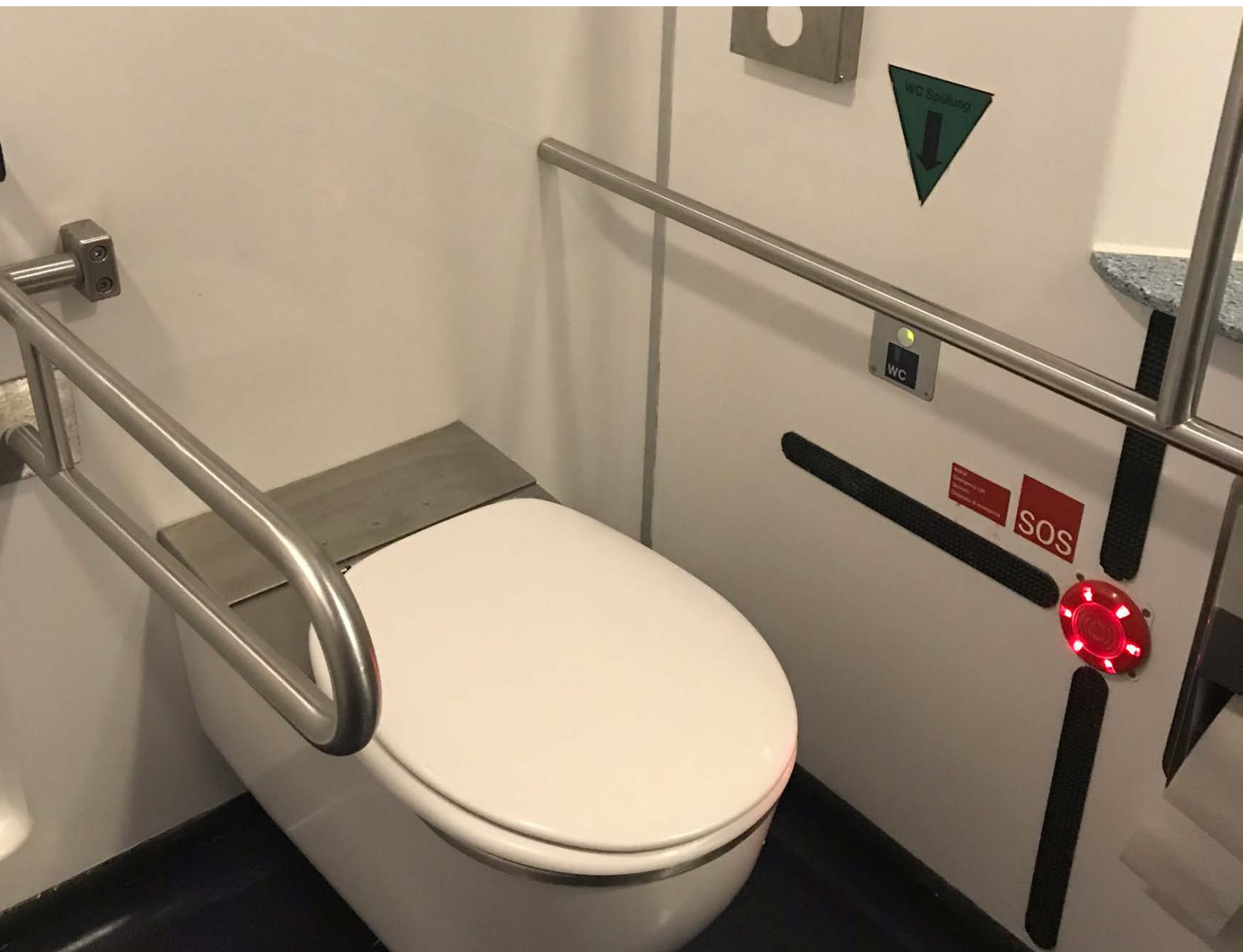


Image 4.25 Accessible Washroom with SOS facility  
Photo Credits: Dr. Gaurav Raheja

operate and located with its bottom edge between 800 mm and 1100 mm above floor level.

6. For a corner toilet room, the reset button should be above the fixed horizontal grab rail beside the toilet paper holder.
7. The marking of the reset control shall be both visible and tactile.

#### **4.9.13 Shower Cubicles**

##### **4.9.13.1 Size**

1. Shower cubicles should have minimum interior dimensions of 2000 mm x 2200 mm.
2. A toilet cum shower room will have minimum interior dimensions of 2400mm x 2500mm.
3. The minimum clear floor space in front of the shower entrance should be 1350mm x 900 mm with the 1350 mm dimension parallel to the shower entrance.
4. The floor of the shower should be slip-resistant.

##### **4.9.13.2 Grab bars for the shower cubicle should:**

1. Have one L-shaped bar or two grab bars in L-shaped configuration between 700 mm and 800 mm from the shower floor.
2. Have one grab bar at least 750 mm long installed vertically with another at least 900 mm long mounted horizontally.

##### **4.9.13.3 Fittings and Accessories**

1. A shelf should be provided for toiletries between 400 mm to

800 mm.

2. All shower controls should be at 500 mm from the rear wall.
3. Shower controls should be installed between 750 mm to 1000 mm from the floor.
4. The adjustable and detachable shower head (telephone shower/hand-held shower), with a minimally 1500 mm long hose, should be installed between 800 mm and 1200 mm from the floor.
5. Where the shower head is mounted on a vertical bar, the bar should be installed so as not to obstruct the use of grab bars.
6. Curbs for the roll-in shower cubicle should not be more than 10 mm high, bevelled at a slope of 1:2.
7. Enclosures for the shower cubicle should not obstruct transfer from wheelchair onto shower seat.

##### **4.9.13.4 Shower seat**

1. A wall mounted shower seat, preferably fold up kind.
2. The shower seat should be positioned such that the distance between the centreline of the water closet and the adjacent wall is 450 mm to 480 mm, and the distance between the front edge of the water closet and the rear wall is 650 mm. The top of the shower seat should be at a height of 450 - 480 mm from the floor.
3. There should be an adequate clear floor space of at least 1350 mm depth and 900 mm width, both in front and on the transfer side, adjacent to the water closet.

a. Be self-draining, non-slip and with rounded edge.



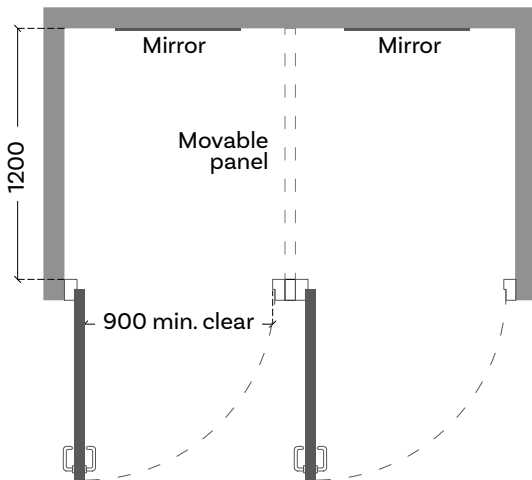
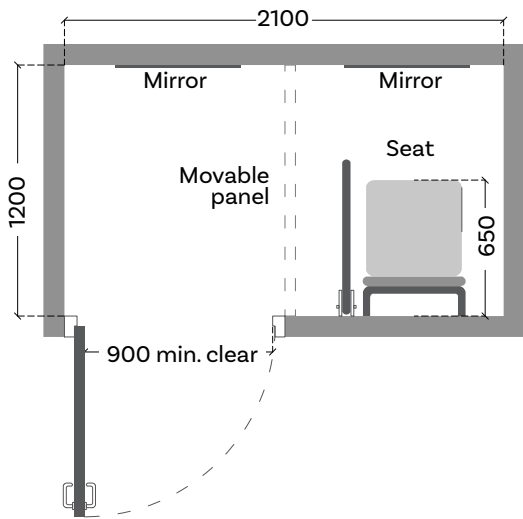
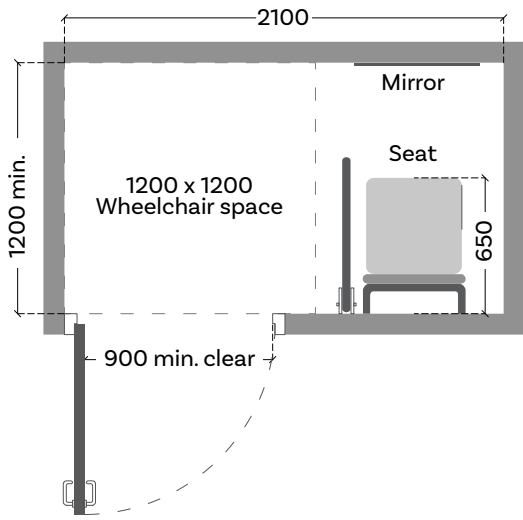


Figure 4.38 Changing room with seat details

Image 4.26 Shower seats

Source: <https://dir.indiamart.com/impcat/shower-seats.html>  
<https://ropox.com/products/shower-seat/>

- b. Be on the wall nearest to the controls.
- c. Have a minimum dimension of 400 mm wide extending the full depth of the cubicle, less a space required for the shower curtain.

#### **4.9.14 Additional Considerations**

There should be adequate colour and tonal contrast between the fixtures, walls, and the flooring. This is to enable easy recognition by persons with visual impairments.

#### **4.9.15 Lactation Room/ Baby feeding room**

A lactation room is a dedicated enclosed place where mothers can breastfeed their babies or express milk in a private and comfortable environment. A lactation room should provide a quiet environment and be equipped with :

1. Comfortable seating, preferably armchairs or similar.
2. Diaper changing stations.
3. Waste containers for the disposal of used diapers.
4. Wash basins with liquid detergent and paper towels.
5. Dispensers for hot and cold water.
6. Vending machines for beverages and diapers.
7. Electrical outlets for breast pumps.
8. Mirrors.

#### **4.9.16 Children Facilities in Washrooms**

At least one child-sized water closet should be provided in each of the male and female toilets. The water closet seat

should be at a height of between 250 mm to 350 mm from the finished floor level.

A seat adaptor with a small seat cover suitable for use by young children may be provided for existing buildings under exceptional circumstances. The hanger holding the seat cover should be mounted at a level that is easily accessible to young children. A portable and stable stool should also be provided as a stepper for young children who may not be able reach the water closet.

Bath liquid dispensers and a flexible hose with water spray head should be provided in the water closet compartment so that parents or guardians are able to clean their child.

#### **4.9.16.1 Urinals**

At least one urinal mounted at a height of about 400 mm from the finished floor level should be provided in the male toilet for young children.

#### **4.9.16.2 Wash basin**

A child-sized wash basin should be provided to allow young children to wash their hands without assistance. The wash basin should be equipped with sensor-operated taps. The height of the wash basin should be at about 550 mm from the finished floor level.

#### **4.9.16.3 Child Protection Seat**

A child protection seat should be provided in one of the water closet compartments for both male and female toilets. This will allow parents to seat their baby safely in the washroom with them.

A child protection seat should:

1. Be equipped with straps that can be extended over shoulders and between legs to ensure the safety of the baby.





Image 4.27 Accessible child-sized Wash basin  
Photo Credits: Dr. Gaurav Raheja



Image 4.28 Accessible Washroom with diaper changing station  
Photo Credits: Dr. Gaurav Raheja





**Image 4.29 Child Protection Seat**

Source: <https://www.totalrestroom.com/products/koala-kare-kb10201-bobrick-wallmounted-child-protection-seat-grey>

2. Be mounted on a solid wall for stability.
3. Be able to accommodate a child weighing up to about 20 kg.
4. Be mounted with its bottom at least 400 mm above the finished floor for easy reach and with adequate space for parents to manoeuvre around the seated child.

#### **4.9.16.4 Diaper Changing Station**

1. A diaper changing station should be provided within every family washroom for use by either parent and in every cluster of toilets for both male and female toilets.
2. A diaper changing station should:
  - a. Be stable and equipped with safety straps and barriers lengthwise to ensure the safety of the infants.
  - b. Have a concave changing surface to ensure comfort and protection of the child.
  - c. Withstand a static weight of

about 130 kg.

- d. Be mounted such that the highest edge, or the lip, of the pull-down deck is between 700 mm to 850 mm above the finished floor level when open.
- e. Be provided with clear instructions to facilitate safe use.
- f. Be provided together with dispensers for bed linens and wet wipes for hygiene purposes.

#### **4.9.17 Signage of accessible toilets**

1. All unisex accessible toilets should have signage represented by the International Symbol of Access (ISA).
2. For individual accessible cubicles in Female and Male toilets shall be easily identifiable with the sign for International Symbol of Access (ISA).
3. All unisex or gender inclusive toilets should be clearly distinguishable with good signage.
4. For the benefit of the persons with vision impairment, all signages must



Image 4.30 Accessible Baby changing facility  
Photo Credits: Shreya Shetty

be supplemented by tactile features and separate signage in Braille.

5. A distinct audio sound (beeper/clapper) may be installed above the entrance door for identification of the toilets.
6. Many persons with visual

impairments find it convenient to use the toilets where internal dimensions, accessories and fixtures placement are standardized. A tactile layout of the toilet should be provided on the wall, near the latch side between 900mm to 1200mm height range.



Image 4.31 Signage for accessible toilets  
Photo Credits: Shreya Shetty





Image 4.32 Indian WC Signage  
Photo Credits: Dr. Gaurav Raheja

#### 4.9.18 Residential washrooms

1. The toilets in residential environments like independent houses, multi-storey housing, gated communities, affordable housing etc, also need to ensure universal accessibility and adaptability to the life span needs of the diverse residents.
2. At least one washroom in each residence shall ensure complete compliance with universal accessibility features. However, the other washrooms (if any) shall be designed to ensure adaptability to diverse disability types or other functional limitations of its residents.
3. The door shall have a clear width of 900mm (minimum) excluding the door frame and door thickness. It is recommended to have lever handles and other door hardware as per Section 4.10.8
4. The floor surfaces shall be non-skid type with a contrasting color scheme





Image 4.33 Fold-able seat for changing room  
Photo Credits: Shreya Shetty

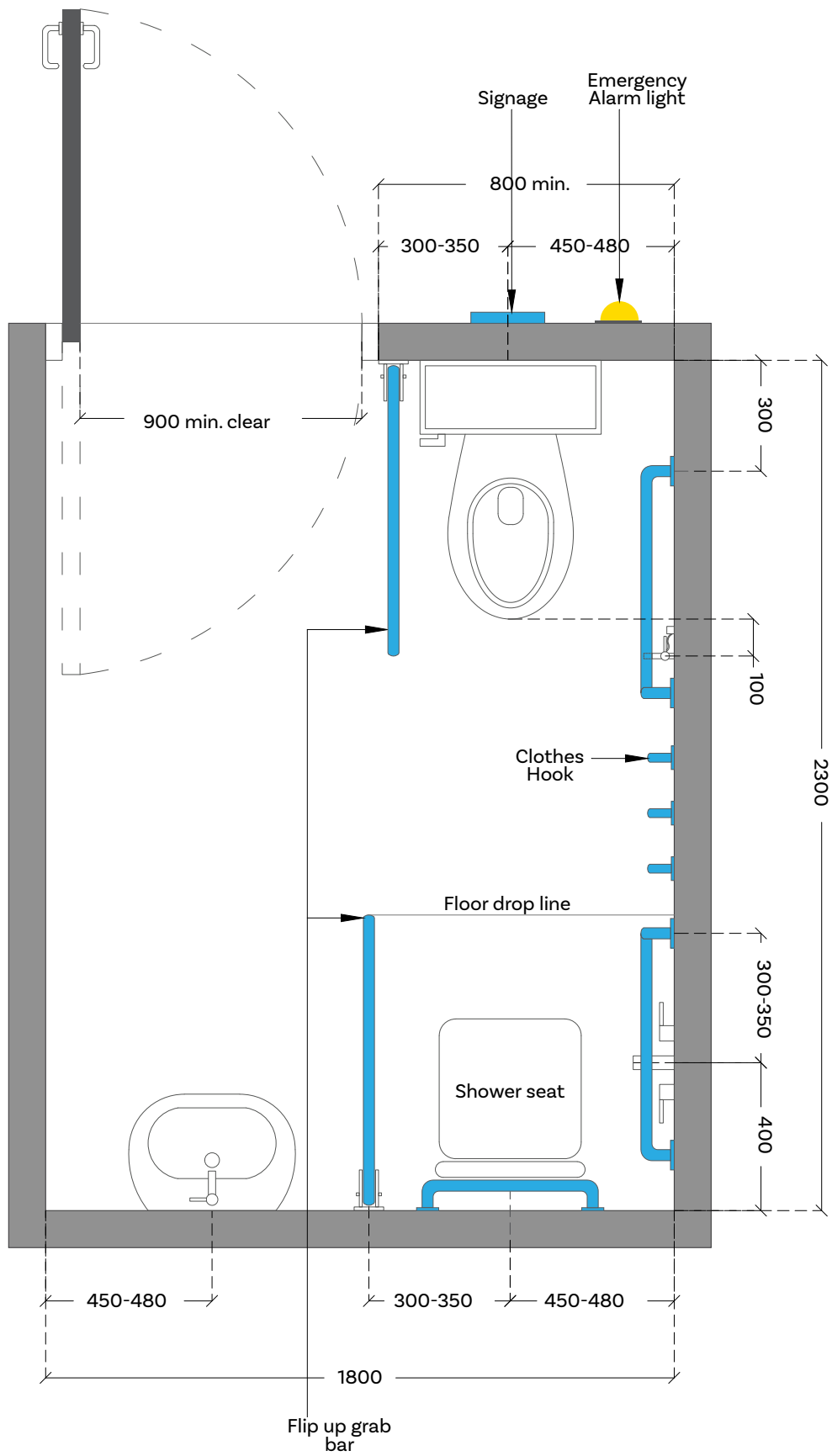


Figure 4.39 Typical Residential Toilet detail: Type A



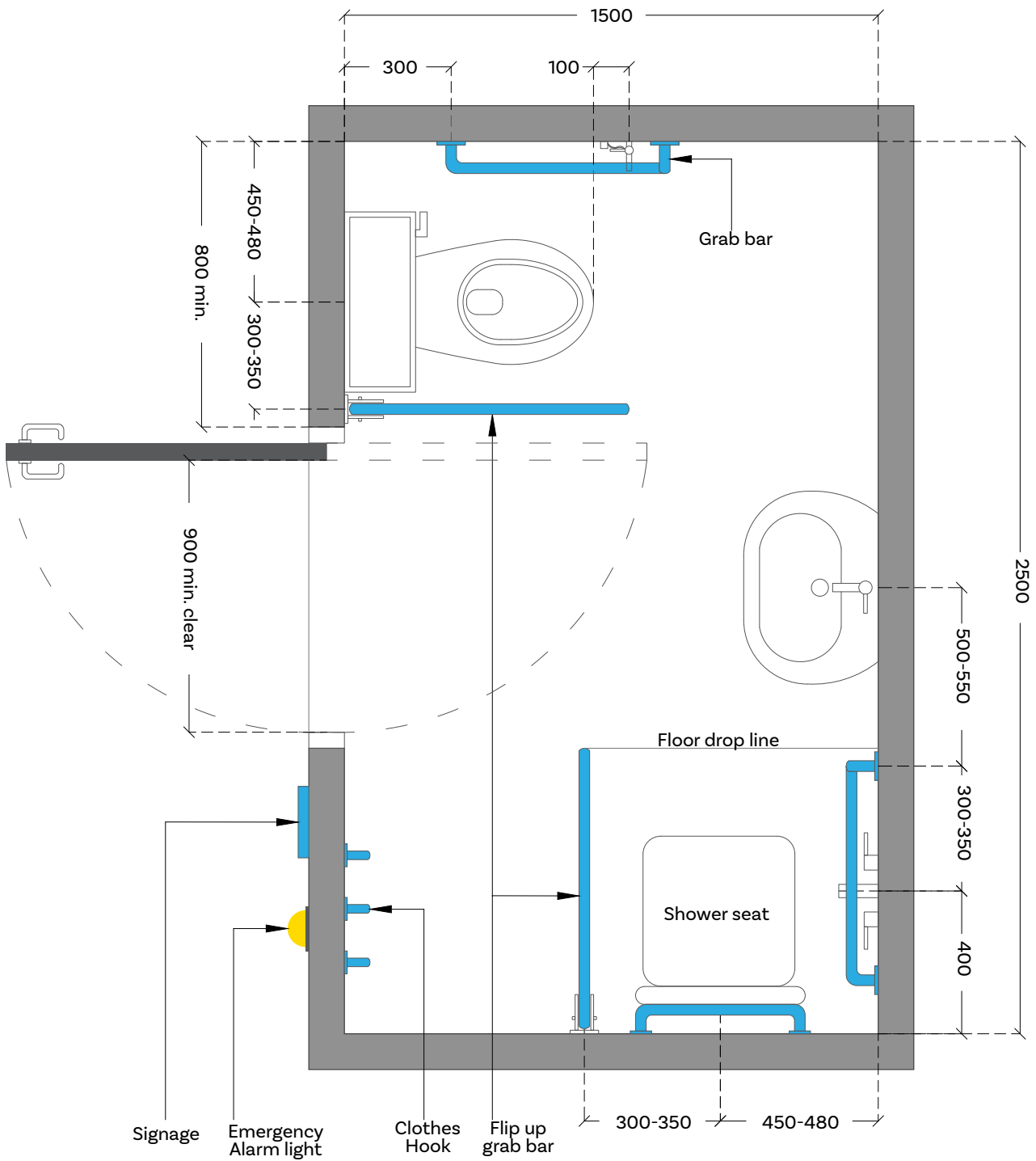


Figure 4.40 Typical Residential Toilet detail: Type B

## 4.10 Internal Doors & Fixtures

Doors and their fixtures remain critical to accessibility in any building space of any scale or size. It is through the doors that the first experience of space begins and hence the level of care in planning, designing and detailing it needs. The attributes of door including its width, type of fixtures, its operability, etc. remain determining factors for its accessibility. With advancing times, even though a wide range of possibilities emerge in door systems, it is recommended to adhere to the following guidelines for door systems in buildings.

### 4.10.1 General

1. Doorways should be levelled.
2. Wherever possible, power or sensor operated door shall be provided for buildings with higher occupancy load. The automatic doors should be configured with manual operation in case of any power failure.
3. Wherever revolving doors or turnstiles are installed they should be supplemented with an auxiliary side-hung (swing type) door with 900mm minimum clear opening width.
4. Bathroom (toilets/washroom) doors should swing out/ should be two way opening type so that the person inside does not fall against the door and block it. In case there is not much space available, consideration should be given to the use of sliding or folding doors, which are easier to operate and require less wheelchair manoeuvring space.
5. Door should not be too heavy to operate and should not require a force of more than 2.5 N to 5 N to operate.
6. Automatic doors should have a push button system to open them.
7. The door should not be of a highly polished/ reflective material such as

stainless steel. The door colour must be in contrast with the door frame or the wall.

8. All external doors should have warning blocks installed 300mm before entrances.
9. If there is a revolving door, an alternative door shall be provided.
10. Automatic doors are preferred for public building entrance

### 4.10.2 Clear width

The minimum clear opening of doorways should be 900mm, measured between the face of the door and the face of the door stop with the door open at 90 degree.

### 4.10.3 Thresholds

1. Thresholds should be avoided under usual circumstances.
2. If thresholds are unavoidable, they should not exceed 12 mm and those exceeding 5 mm should be bevelled.

### 4.10.4 Double-leaf doors

In case the door has two independently operated door leaves, at least one active leaf should have a minimum clear opening of 900mm.

### 4.10.5 Manoeuvring spaces at doors

1. A minimum distance of 600 mm should be provided beyond the leading edge of the door to enable a wheelchair user to manoeuvre and to reach the handle.
2. Wheelchair or other manoeuvring spaces for assistive devices like rollators, baby strollers, etc. should be

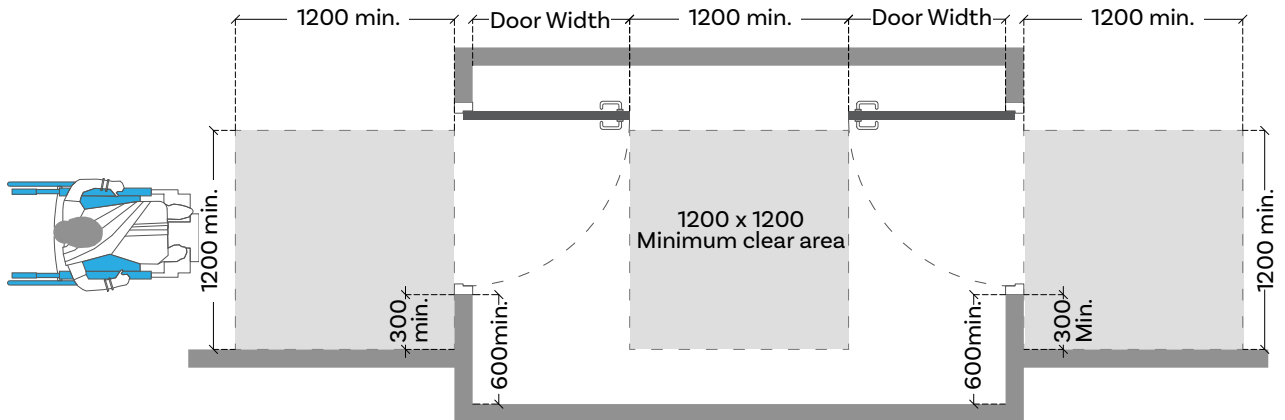


Fig a: Doors in a series opening in opposite directions

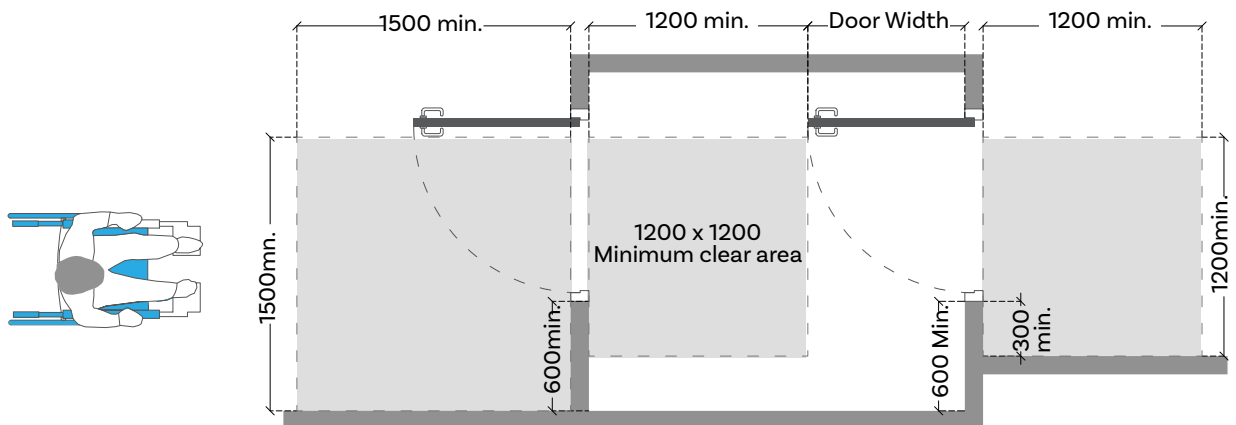


Fig b: Doors in a series opening in the same direction

Figure 4.41 Minimum maneuvering space for two aligned doors in a series

free of any obstructions and space should be provided on the side of the door handle in the following manner :

- a. on the pull side, a minimum space of 600 mm adjacent to the leading edge of the door with a minimum clear floor space of 1500 mm wide by 1500 mm deep.
- b. on the push side, a minimum space of 300 mm adjacent to the leading edge of the door with a minimum clear floor space of 1200 mm wide by 1200 mm deep.
- c. Where two-way swing doors or

sliding doors are used, a minimum space of 300 mm adjacent to the leading edge of the door with a minimum clear floor space of 1200 mm wide by 1200 mm deep must be provided on each side of the door.

#### 4.10.6 Two doors in series

The minimum space between two hinged or pivoted doors in series should be 1200 mm plus the width of the door swinging into that space.



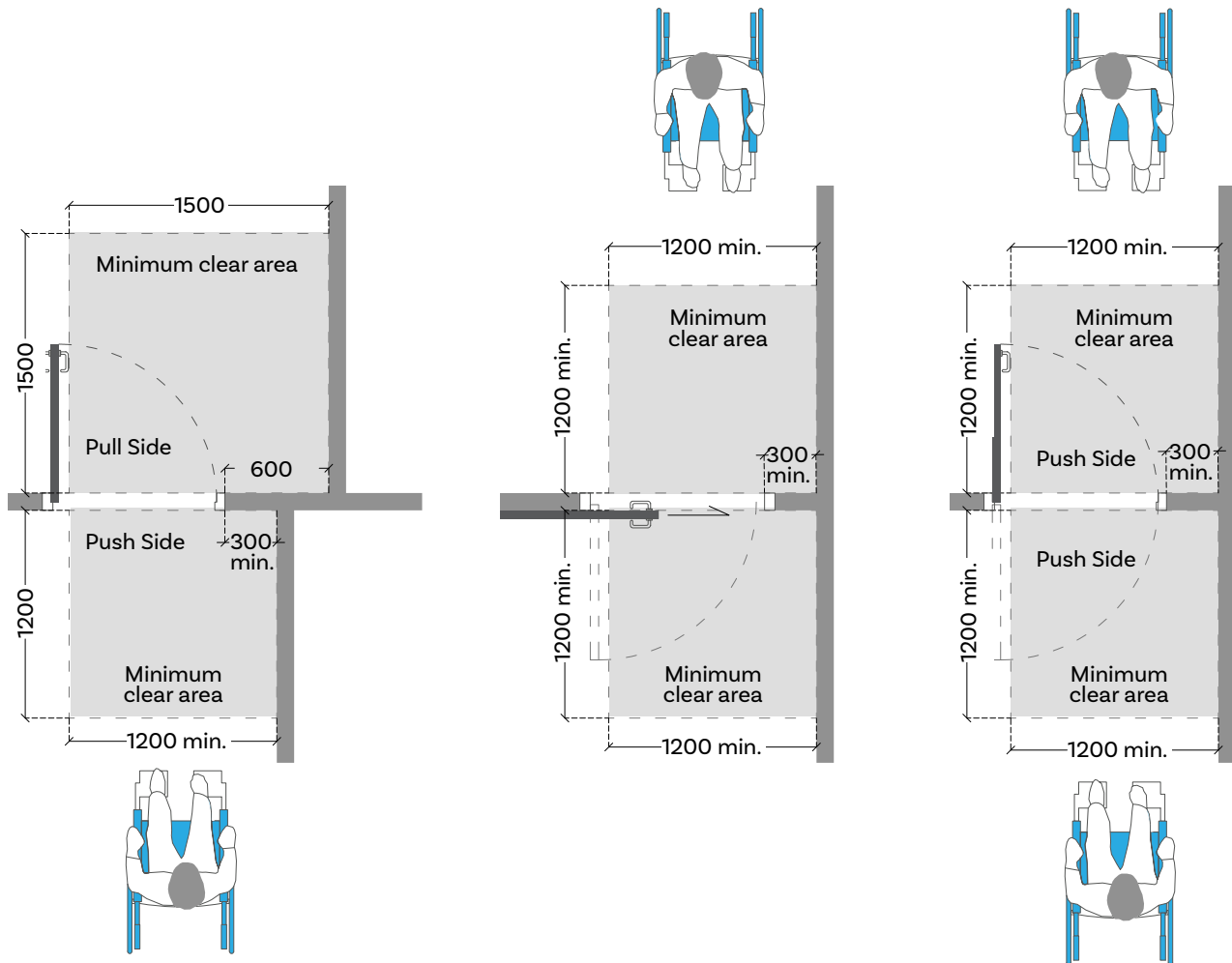


Fig a: Case of one push side swinging doors

Fig b: Case of sliding door

Fig c: Case of both-side push swinging doors

Figure 4.42 Minimum Doorway Manoeuvring Space in Series

#### 4.10.7 Wheelchair manoeuvring space

1. To enable wheelchair users to approach doors, manoeuvring space is needed. The corridor should have a width of at least 1200 mm to allow a 90° turn to be made through a door. In narrow spaces sliding doors may be preferable.

#### 4.10.8 Door hardware

Operable devices such as handles, pulls, latches and locks should:

1. Be operable by one hand; Not require fine finger control, tight grasping, pinching, or twisting to operate.
2. Be mounted at a height of 800 mm to 1100mm from the floor.
3. For easy identification by persons with visual impairment all door hardware should contrast visually with the surface of the door.
4. The location and design of latch and push/pull handles should be consistent throughout a building and should be convenient for all including

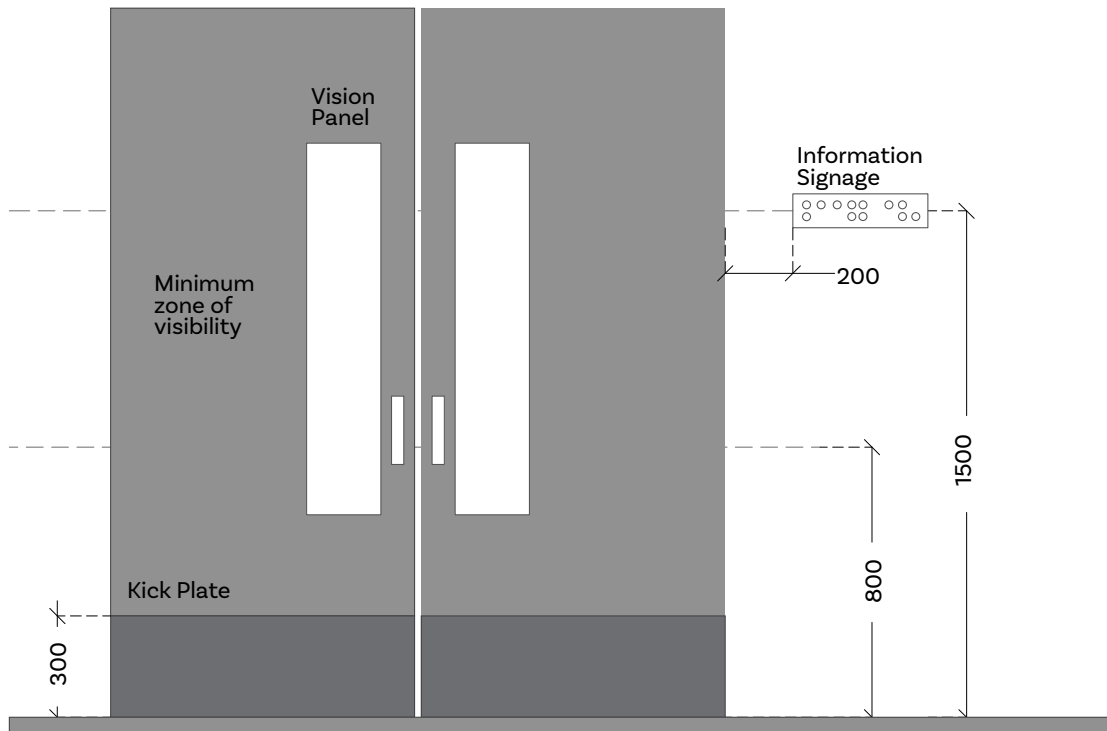


Fig a: Vision panels and Kickplates on doors

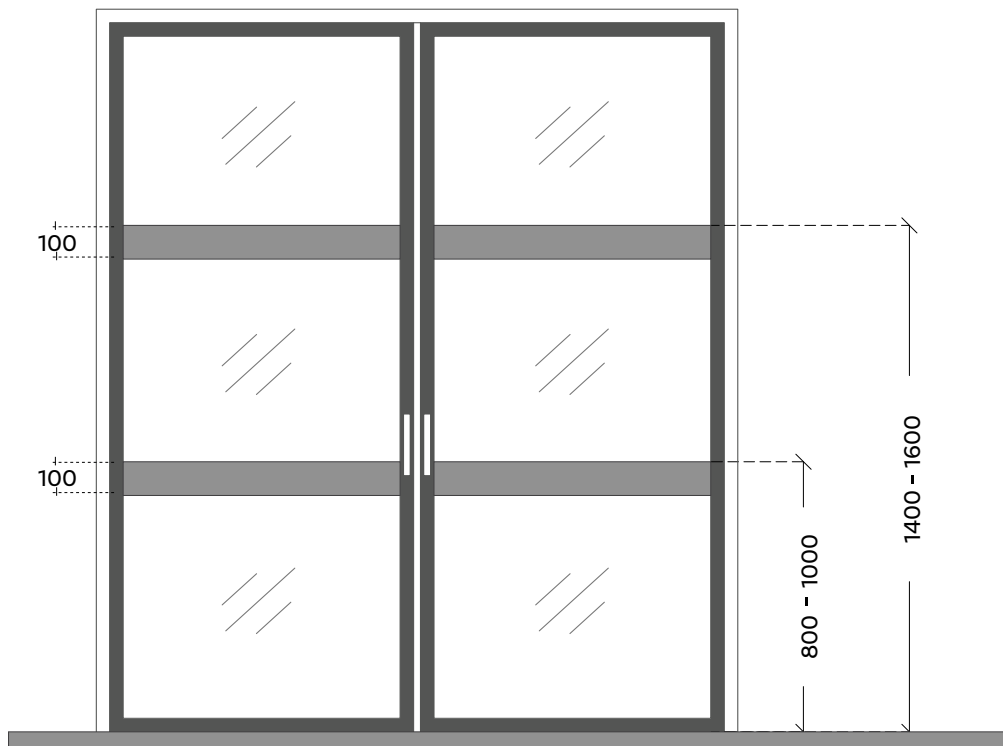


Fig b: Markings on Glass Doors

Figure 4.43 Doors

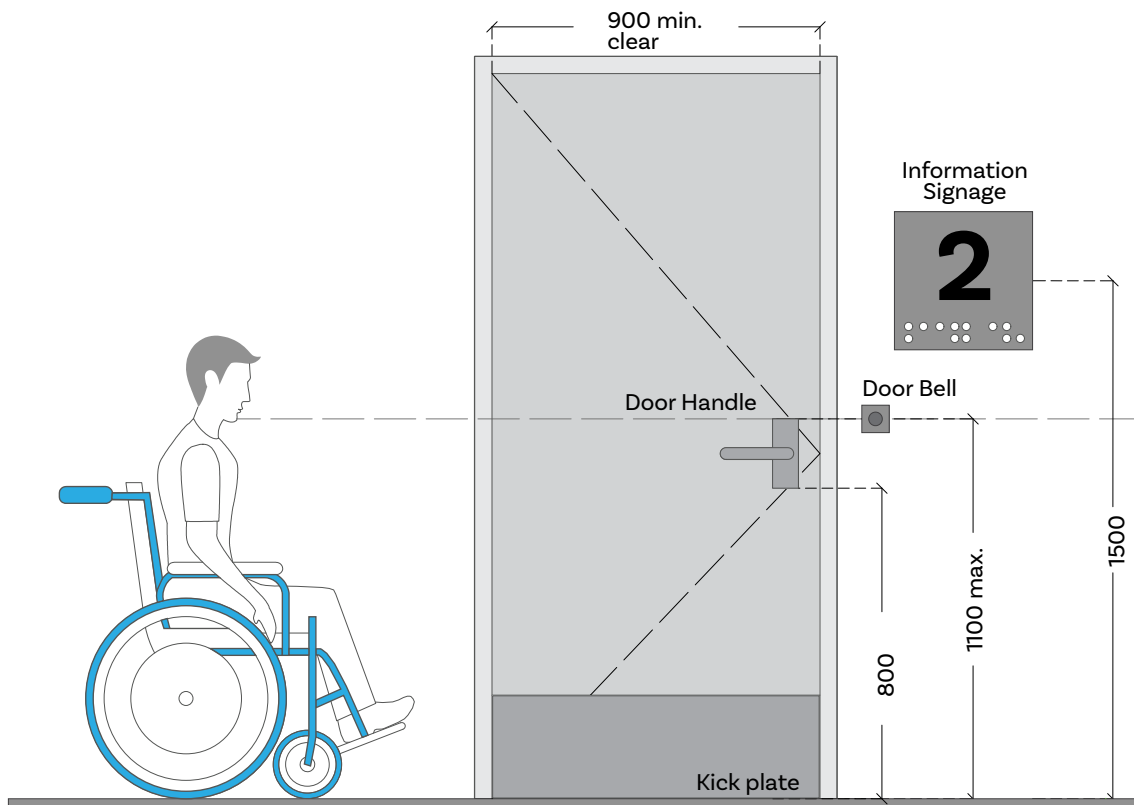


Figure 4.44 Door details

persons with hand grip limitations, etc.

5. It is recommended to provide bolting or latching mechanisms at multiple levels especially in dedicated accessible facilities like washrooms, etc. to include persons with upper limb extremities. The recommended levels could be at the bottom level (i.e. 200 mm to 300 mm from floor level), mid level (800 mm to 1000 mm) and top level (1800 mm to 2100 mm).
6. To facilitate the closing of a door by wheelchair users (for example, a water-closet compartment that does not have a self-closing mechanism), the door should have a horizontal handle, provided on the closing face of the door, approximately 750 mm from the floor.

#### 4.10.9 Door handles

The following characteristics are recommended:

1. Push-pull mechanisms that require no grasping.
2. Lever handles to be preferred on latched doors.
3. It is safer to use D shaped handles as they reduce the risk of catching on clothing or injuring from the exposed lever end.
4. Doorknob is not recommended, as it does not provide adequate grip for persons with impaired hand functions.
5. The door handle should contrast with the colour of the door.



#### 4.10.10 Sliding/Folding doors

1. Operating hardware should be exposed and usable from both the sides when the door is fully open.
2. Should have a vertical bar handle to operate the door. The handle length should be minimum 140 mm.
3. Be installed between 60 mm and 130 mm from the door jamb or door stop when in open or closed positions.

#### 4.10.11 Power Operated Doors

Power-operated doors must be either automatically controlled, for example, by motion sensor, or manually activated by a control such as a push pad. The push pad should, preferably, not be mounted on a glass door. If unavoidable, the height should be between 800 mm and 1000 mm from the finished floor level.

### 4.11 Windows

Windows and openings in buildings play a responsive role to enhance air and light quality into building interiors besides creating a visual connect between inside and outside. Accessible windows and openings imply appropriate planning of fenestrations, sill levels, overall size, fixation details, ease of operations and the experience of connect between inside and outside. Designing window systems in buildings requires to consider accessibility in perspective of various associated functions including visual connect for diverse categories of persons with disabilities alongwith other functional limitations.

#### 4.11.1 Windows

1. All building typologies shall place

their window systems while keeping provision of adequate manoeuvring spaces for wheelchairs, baby strollers, etc. in the zone of window and it's operability.

2. Window sills shall not be higher than 800 mm, keeping in view wheelchair users or persons with short height statures. They should provide an unobstructed viewing zone for wheelchair users between 750mm and 1400mm. (Refer Fig. 4.45)
3. Windows or openings in high rise buildings shall consider providing guard rails around sill levels to provide support and prevent falls.
4. Windows should have handles and other controls upto a maximum height of 1200 mm or in accordance with Section 4.15. It is recommended to use lever type hardwares for openings.
5. To regulate daylight in building interiors, controls or ropes to operate curtains or venetian blinds should be placed 800 mm to 1000 mm high from the finished floor level for users with diverse functional limitations including wheelchair users/short stature persons.
6. Windows shall be planned to ensure adequate ventilation and daylight in the spaces without causing glare while enhancing visual contrast of surfaces.
7. Window frames shall be in contrasting colour to the wall and sills where they are placed.
8. Window opening should not cause an obstruction to a moving person esp. persons with visual impairments and others to avoid any accident.

#### 4.11.2 Glass surfaces

1. All glass surfaces that could be

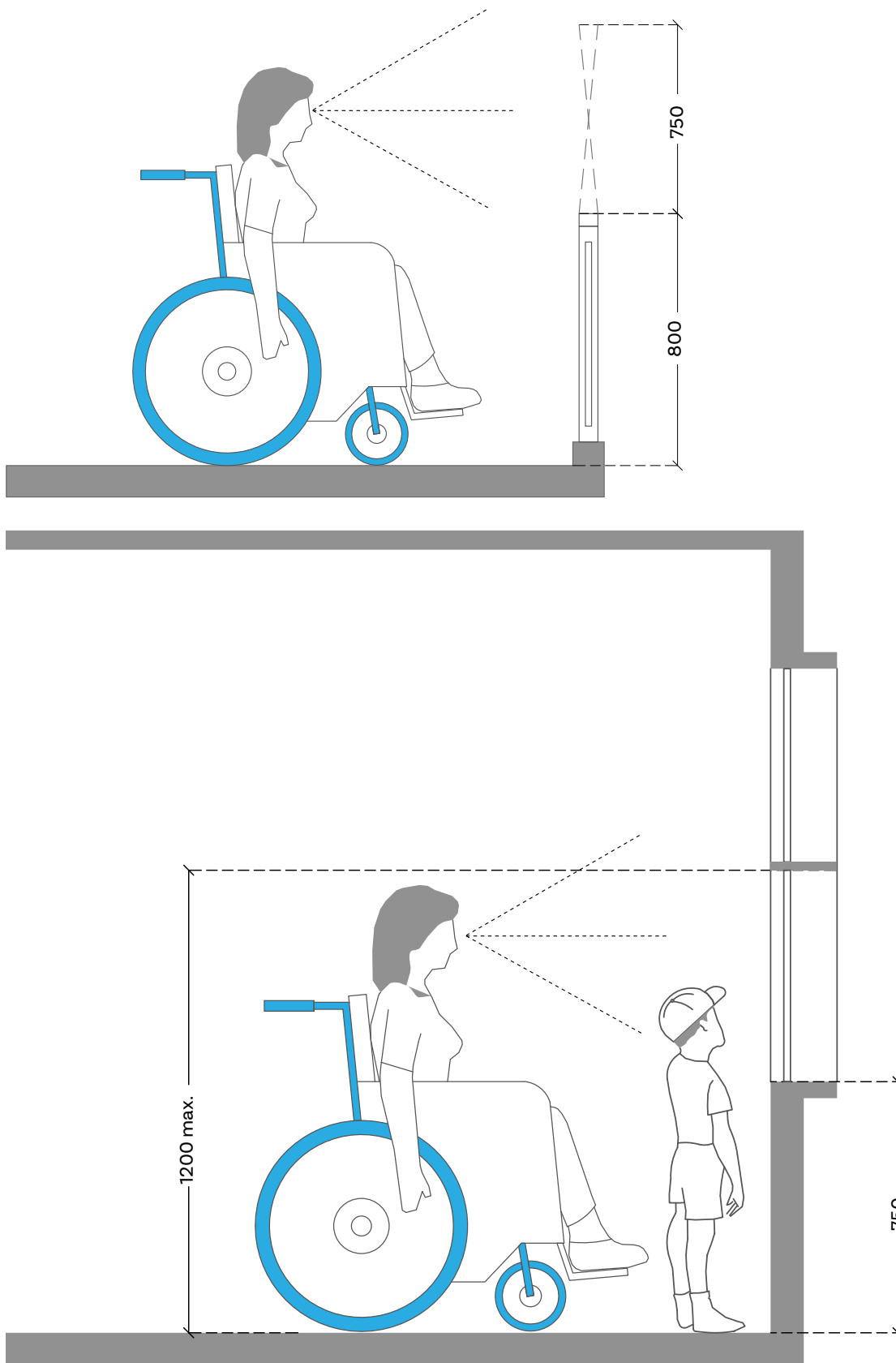


Figure 4.45 Unobstructed view

confused with doors or openings, as well as the glass doors that do not have elements that can be identified, such as frames or handles, shall contain visual elements that guarantee its detection.

2. The marks shall consist of two horizontal bands, each at least 100 mm high, and shall have a reflectance contrast with the glass background of at least 30 points LRV (Light Reflectance Value).

#### 4.12 Guest Rooms

In built environments or building typologies like hotels, motels, guest houses, rest houses, lodges, hostels, studio apartments, etc. it needs to be ensured that a minimum of five percent rooms are to be made universally accessible while all other rooms shall have adaptive features to accommodate guests with special needs. The percentage figures shall be considered with a nearest round up. For smaller establishments with less than 20 rooms, a minimum of two accessible room units shall be required. The same recommendations shall be applicable to Studio Apartments as well.

1. An accessible guest room implies various features like the presence of a wide doorway, adequate maneuvering space in the room interior, access to bed transfer and washrooms with convenience and independently besides easy access to controls, switches and safety signals or alarms.
2. Further, accessible guest rooms must be well serviced by staff trained for accessibility support services in case of assistance.
3. Doors of all guest rooms shall be made accessible as specified in Section 3.10.

4. A viewing device should be provided in the door at a height of between 800 mm to 1000 mm.
5. A clear circulation route shall be provided to the bed with a minimum clear space of 1500 mm x 1500 mm beside the bed.
6. The bed shall have a maximum height of 500 mm.
7. A minimum illumination of 200 lux shall be provided by at least one lighting fixture in the room.
8. The accessible rooms shall be provided with acoustic and visual fire alarms as well as an audible doorbell.
9. Shelves and drawers shall be provided between 700mm to 1200 mm from the floor, and whenever possible a clothes hanger should be placed at 1100 mm from the floor.
10. A dressing mirror where the user can see his or her reflection from 250 mm to 2000 mm shall be provided.
11. An accessible toilet with grab bars, an accessible shower and vanity shall be provided alongwith the guest room.

#### 4.13 Eating Spaces

A varied, flexible arrangement of tables and seats should be provided to cater to patrons with different needs and abilities, which include families with young children, older persons, wheelchair users, persons with neurodiversity and other functional limitations. Accessible eating spaces have a potential to create socially inclusive environments by incorporating the needs of a wide range of persons with diverse and special needs.





Image 4.34 Accessible entry to an eating space  
Photo Credits: Dr. Gaurav Raheja

Eating spaces includes establishments like restaurants, cafeteria, canteens, dining mess, banquet halls, food courts and other eating outlets or establishments with similar functions.

Accessible eating outlets shall principally have accessibility incorporated into its features from parking to entrance, from waiting zone to seating, from circulation space to washrooms besides accessibility in the food services.

#### 4.13.1 Seating Arrangement

1. Where fixed seating is provided in eating outlets and establishments, at least one table for every 10 tables or part thereof must be provided for use by persons with disabilities or at least two tables, whichever is the greater.
2. The height of the table provided for

persons with disabilities must not be higher than 800 mm with a minimum clear knee space of 680 mm high and 480 mm deep.

3. Where the eating outlet or establishment is provided with fixed seats, the minimum clear space between the seats must be 750 mm measured along the edge of the table.
4. The furniture layout should permit the movement of children strollers and other mobility devices like wheelchairs, rollators, etc.
5. Seating arrangement shall be flexible in design to enable group dining for several occasions.

#### 4.13.2 Circulation within an Outlet

1. A circulation path with a minimum clearance of 1200 mm wide must be





Image 4.36 Typical accessible seating furniture  
Photo Credits: Dr. Gaurav Raheja

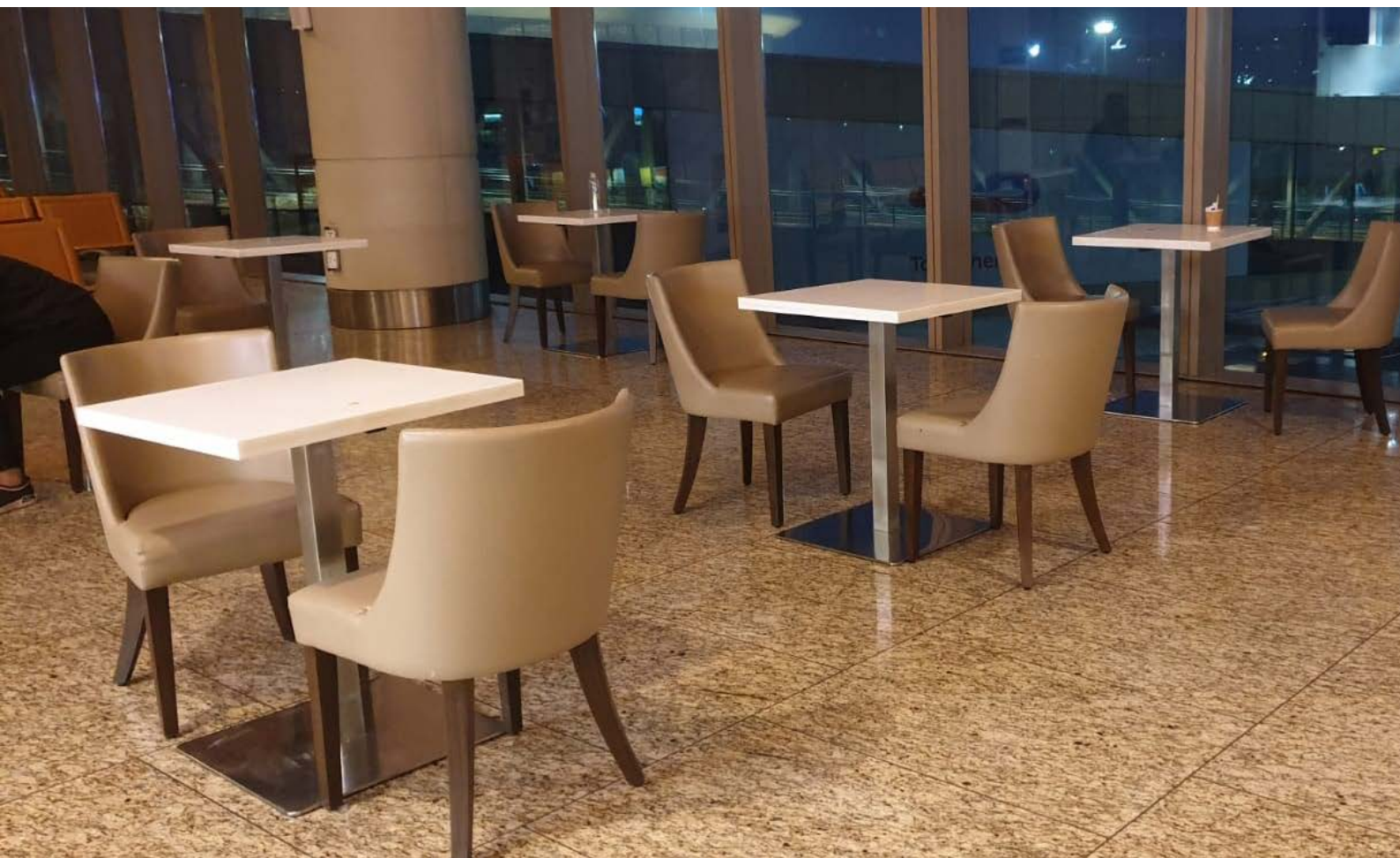


Image 4.35 Typical accessible seating arrangement  
Photo Credits: Shreya Shetty

provided in front of the stalls.

2. An accessible route with a minimum clear width of 900 mm must be provided from the circulation path to the tables intended for persons with disabilities.
3. Evacuation routes and services from eating outlets shall be well designated through signage and supported by appropriate mechanisms of response during emergency situations.

#### 4.13.3 Seating Furniture

1. The height of the table provided for persons with disabilities must not be higher than 800 mm with a minimum clear knee space of 680 mm high and 480 mm deep.
2. Tables and seats should be selected to provide an effective visual contrast with the surrounding surfaces so that they can be clearly identifiable.
3. Materials used for tables and seats should be heavy-duty, corrosion-resistant, easily maintained, durable and not easily stained.
4. Cantilevered tables or tables with straight legs at each corner are preferable to central pedestals that might restrict wheelchair access
5. The furniture laid out shall not have sharp edges or corners that could cause injury or obstruction to anyone including persons with visual impairments.
6. Stools and high tables are not suitable for wheelchair users.
7. In self-service restaurants, tray slides and counters should be mounted at 800mm from the floor for wheelchair users.
8. Food shelves should be mounted at a maximum height of 1200 mm and aisle space of minimum 900mm

should be provided.

9. Adequate baby chairs with sides and backrests, and a safety belt or T-bar should be provided in eating places. The baby-chairs should be stable and preferably portable.
10. Informal kiosks for eating on streets or in urban public spaces shall also make suitable arrangements for accessibility. Wherever, the guest is expected to dine on counters, a part of that counter shall be kept not higher than 800 mm.

#### 4.13.4 General

1. Illumination of at least 100 lux shall be provided in at least 10% of the dining room.
2. Sound absorption materials should be incorporated into dining rooms for better acoustic environments.
3. Wherever the eating spaces are serviced, the personnel should be sensitized about the needs of persons with disabilities and others with functional limitations.
4. Food menus shall be readable or accessible for all especially keeping the functional limitations of persons with visual impairments and language diversity into account. This implies menus to be prepared in readable fonts with adequate visual contrast and in two distinct languages to support readability across cultures.
5. Old and new restaurants or cafes or bars including formal and informal eateries in public space environments are recommended to adopt the above mentioned guidelines to facilitate access and inclusion for all.
6. Accessible washrooms with family friendly facilities shall be provided to each eating space





Image 4.37 Accessible furniture in an eating space  
Photo Credits: Dr. Gaurav Raheja



7. The symbol of access shall be displayed on every dining facility which has made accessibility provisions as stated.

#### 4.14 Wardrobes and Storage Shelves

Wardrobes and storage systems in diverse building typologies need to sensitively consider a wide range of user heights and conveniences to access them. Independent living of elderly, persons using wheelchairs or with other disabilities have specific needs while using wardrobes and storage systems. While they could be customised for individual

users in personal home environments, they require to be planned for in public space environments as well like retail spaces, self help stores, etc. Following recommendations shall imply to create universally accessible wardrobes and storage systems:

1. Shelves and storage spaces should be between 300 mm and 1200 mm height from the floor surface.
2. The features to operate storage and wardrobe systems shall be designed such that they require low physical effort in opening and closing. This supports at individuals with weak grips or other functional limitations can also operate with ease.

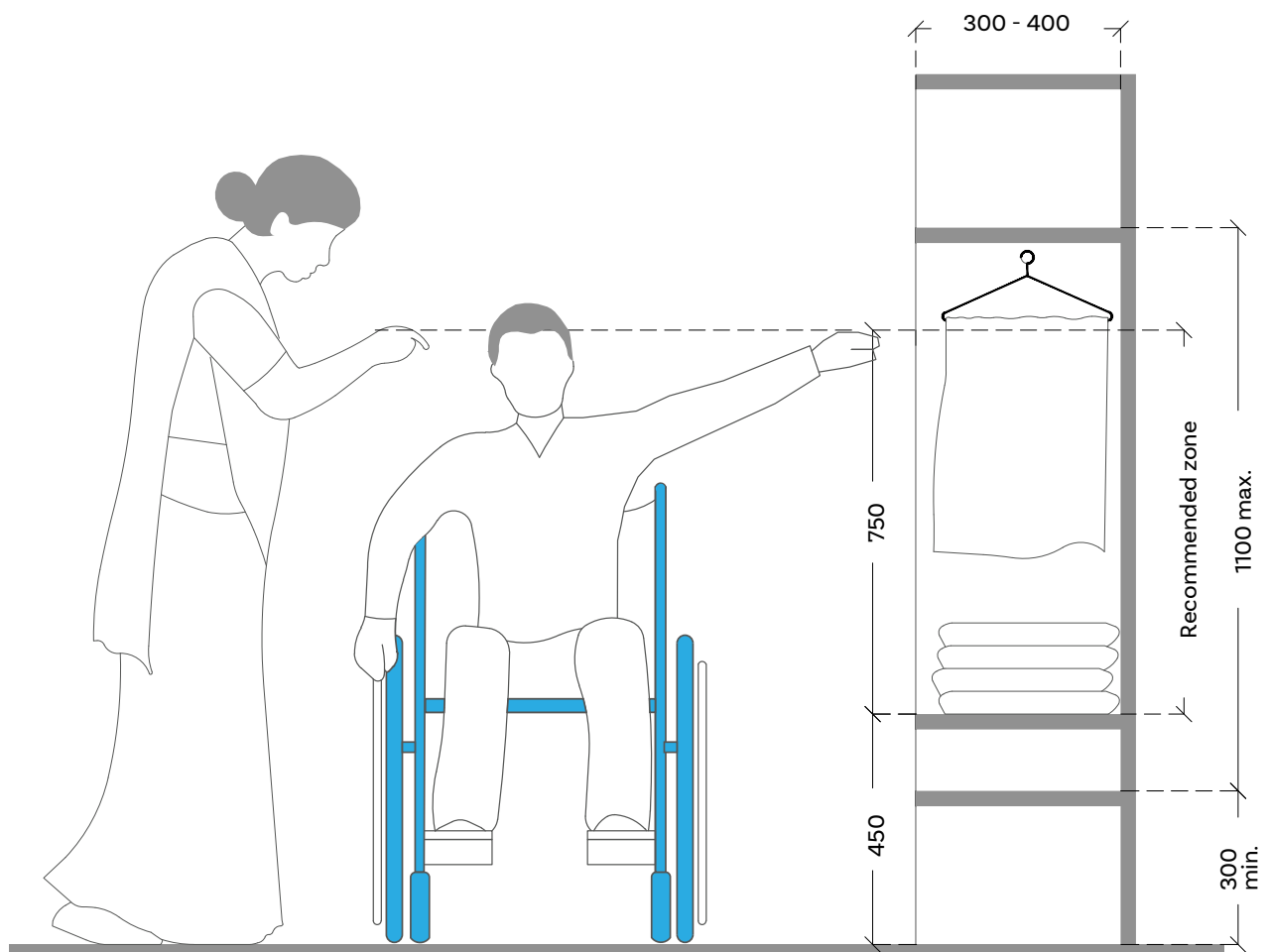


Figure 4.46 Storage space for a wheelchair user

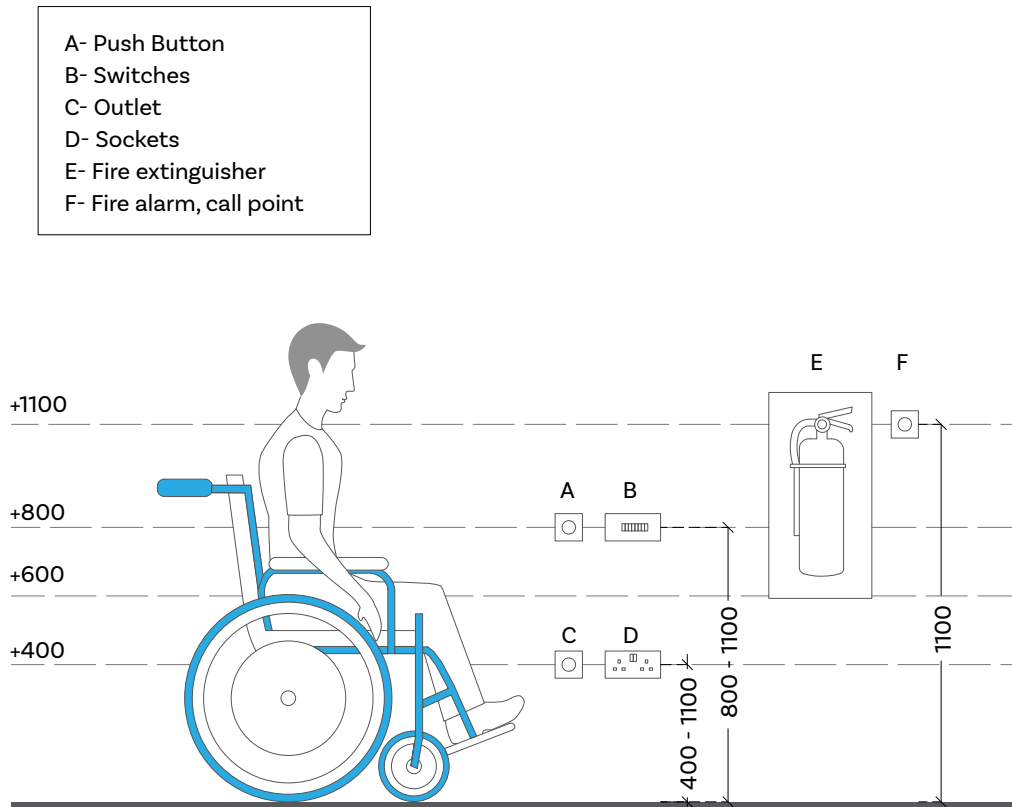


Figure 4.47 Electrical controls mounting details

3. Forward and side reach for wheelchair users as shown in Section 2.8 need to be considered when designing shelving systems for areas like kitchens, wardrobes, retail spaces, office systems, counter shelves, etc.
4. Hanger heights in wardrobes shall be kept at a height of 1100 mm. However, in general wardrobes are recommended to have a feature to customize hanger heights to facilitate ease in access.
5. Storage shelves for kitchen environments may also be designed with adaptability to diverse user groups in home environments. It is recommended to plan kitchen interiors with appropriate features to accommodate aging issues, anthropometric requirements of user groups and physiological needs of diversity in the given home context.

#### 4.15 Controls and Operations

The design and construction of the operating controls and devices should aim to ensure the independent, safe and convenient operation of controls and devices by a wide range of users with or without functional limitations. Some of the possible needs may highlight :

1. The operating controls and devices include but are not limited to
  - a. door or window handles and locks
  - b. levers or mixer taps
  - c. activation devices, vending machines and vehicle park auto-pay machines
  - d. window openers and locks and
  - e. electrical socket outlets and switches.



2. The operable parts of controls should be
  - a. located adjacent to a clear floor space that has a minimum width of 900 mm
  - b. located at a height of between 600 mm and 1200 mm from the floor level with an exception of vending machines where the upper limit is relaxable by a maximum of 100 mm.
  - c. able to cater for wheelchair users, controls and should be placed not less than 400 mm from room corners.
  - d. operable by one hand
  - e. of a type that does not require tight grasping, pinching or twisting of the wrist and
  - f. operable with a force of 2.5N to 5N.
3. Controls must be cognitively easy to operate. For elderly or persons with neurodiversity, complex operational mechanisms shall be avoided. It includes majority persons.
4. Instructions should be clear and logical, incorporating pictograms in addition to text, where possible.
5. Controls and operating mechanisms should be capable of being illuminated to at least 100 lux.
6. If light switches are provided for accessible individual washrooms, accessible changing room or accessible water closet compartments, they should be located at a height of between 800 mm and 1200 mm.
7. Wherever possible, motion sensor lighting is recommended to avoid manual controls and automated response.
8. Key pads, card readers and intercom buttons should be provided at a height of between 800 mm and 1200 mm from the floor level.
9. The operable part of controls, electrical sockets and switches must be located at 350 mm or more from the internal corner of a room or an obstruction.
10. The switch plate shall present at least a contrast of 30 points LRV in relation with the surrounding wall.
11. Installation of charging points in diverse building typologies shall consider integration of diverse typologies of interface ranging from three point socket to USB charging systems to others.
12. It shall be possible to activate it with an elbow.
13. Machine or Digital interfaces for controls shall comply with accessibility guidelines for digital systems like apps, websites, etc. However, the machines themselves shall ensure accessibility from wheelchairs and for other disabilities including visual impairments, etc.
14. Touch sensitive controls be provided with an alternative option of tactile button controls to ease elderly, persons with grip challenges and others with hand related functional limitations.
15. The faucets or taps shall be inclusively designed and placed keeping in view the above recommendations of ease in operability, lever type controls, adequate colour contrast and space for operations.
16. For water outlets with mixers for hot and cold water, colour coding on faucets in accessible formats is recommended for ease of operations.
17. The controls shall be regularly maintained with adequate backup management systems to replace in case of failures.



Image 4.38 Accessible digital kiosk  
Photo Credits: Shreya Shetty



Image 4.39 Accessible hand sanitiser units  
Photo Credits: Dr. Gaurav Raheja



DON'T PASS IT ON



Please use hand sanitiser



RECEPTION

ਰਿਸੇਪਸ਼ਨ

⠠⠠⠠⠠⠠⠠⠠⠠⠠⠠⠠⠠⠠⠠⠠⠠⠠⠠⠠⠠⠠⠠⠠⠠



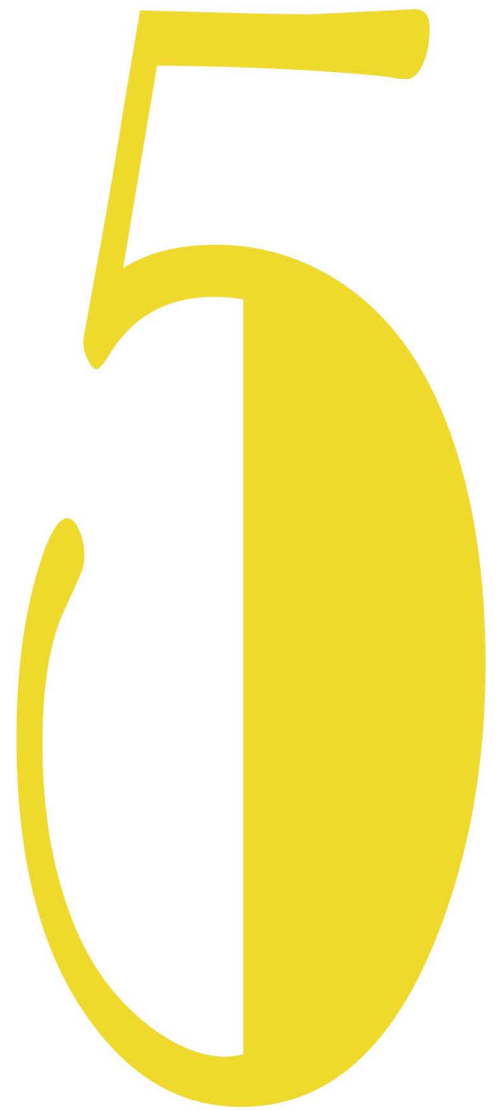
LIFT

ਲਿਫਟ

⠠⠠⠠⠠⠠⠠⠠⠠⠠⠠⠠⠠⠠⠠⠠⠠⠠⠠⠠⠠⠠⠠⠠⠠

# Signage and Information Systems

- 5.1 Information System Perspectives
- 5.2 Signage and Wayfinding
- 5.3 Location
- 5.4 Visual Comfort and Colour Contrast
- 5.5 Tactile and Multi Sensory Information Systems
- 5.6 Tactile maps







*For most of us, technology makes things easier.  
For a person with disability, it makes things possible.*

*- Judy Heumann*



# INFORMATION & WAYFINDING SYSTEMS

# 5

Information accessibility is one of the key pillars of any environment to make it identifiable, usable and safe for diverse user types. Every built environment, be it transportation based, education, healthcare or recreational requires to develop their contextual information system designs to ensure access for all including persons with visual, hearing or cognitive impairments. Legible and clear information enables human functioning and enhances accessibility for most individuals. Every organisation and institution look to strengthen their information systems by using physical signage and digital information and maps on their websites. In contemporary times, any mobility experience usually begins with information access in digital formats before approaching a physical environment.

## 5.1 Information System Perspectives

The context of India provides a beauty of cultural diversity and therefore brings in a perspective of multi lingual population groups as part of user groups in regional towns and urban cities. Keeping the Universal Design approach as a guiding philosophy, it is highly recommended to develop and project information in multiple formats for diverse user groups

preferably by deriving visual language from the local cultural contexts as well.

While information system design involves a wide range of aspects to enable users to reach, navigate, identify and use the built environment, wayfinding remains a critical and common aspect wherein people with diverse needs and abilities get ignored. Example, Persons with visual impairments in a new location may find it challenging to navigate without braille sign or braille maps unless an alternative support is provided for. Likewise, persons with hearing impairments also face challenges in various public environments and may seek clarity on wayfinding. Within a context of emergency and evacuation, the need for information access and wayfinding processes becomes even more critical.

It is therefore important to provide wayfinding information in a variety of different formats such as visual, auditory, olfactory and physical. All people use different forms of information gathering to find their way to their destination but this is especially important for people with disabilities. New technologies are highly recommended in built environments for enhancing wayfinding and information access experience. This includes digital screens, real time display systems, audio visual maps, personalized interfaces, etc.

Every built environment therefore requires to prepare a holistic strategy for information and wayfinding accessibility in its premises and must become part of a regular access strategy for all.

From the user perspective, the wayfinding process involves four stages:

understand and not place Persons with Disabilities or other diverse user types at a disadvantage. Universal signage cuts across the regional/cultural and language barriers as even a common layman can understand the symbols and pictograms.

People need clear information about the purpose and layout of spaces to maintain

Table 5.2 Wayfinding process

S. NO.	WAYFINDING STEPS	MEANING
1.	Orientation	Is the attempt to determine one's own location in a built facility
2.	Route decision	Is the selection of a course of direction to the destination
3.	Route monitoring	Is checking to make sure that the selected route is heading towards the destination.
4.	Destination recognition	Is when the destination is recognized

## 5.2 Signage and Wayfinding

### 5.2.1 Signage

Signs are important to people who are unfamiliar with their surroundings. They help provide information. They can inform the user of a route, a hazard, or a facility. Signs also communicate an identity for the building or environment they serve. Signage contributes greatly to the aesthetics and first impression of a building. Signs must be clear, concise, and consistent.

A signage system also increases a person's awareness of their surroundings and aids orientation within the environment. The location of signs should ideally be part of the process of planning the building and environment. A good and successful sign system shall minimize anxiety and confusion. It must be easy to

a sense of direction and independent use of a building. Often visual and tactile information is reinforced by audible information. Information may take the form of visual information (e.g. signs, notice boards), audible information (e.g. public address and security systems, induction loops, telephones, and infrared devices), or tactile information (e.g. signs with embossed lettering or Braille).

The effectiveness of information on the use of a building is determined by:

- a. The location, accessibility, layout and height of signs;
- b. The size of lettering, symbols and their reading distances;
- c. The use of tactile letters and symbols;
- d. Visual contrast and lighting;
- e. The finished surfaces of materials





Image 5.1 Signage and Wayfinding  
Photo Credit: DMRC

used for signs and symbols;

f. The simultaneous use of audible cues;

g. Integration with any other communication systems.

### 5.2.2 Provisions

1. Information and direction signs should be provided at junctions of circulation routes and key destinations such as doorways, reception points, facilities such as telephones, drinking water facilities, toilets, and in areas where hearing enhancement systems are fitted.
2. Directional signs should readily identify and provide a logical sequence from a starting point to a point of destination and a clear indication of return routes to named exits. The names of destinations should be consistent throughout the signing system.
3. A clear indication of the existence of steps or ramps on a route should be

provided at both ends of the route.

4. Signs to facilities for Persons with Disabilities should incorporate the International Symbol for Accessibility.
5. A building should include spaces where announcements can be transmitted through a hearing enhancement system. Signs should be provided to inform persons with hearing impairment of locations in the building where these systems are fitted, and where they can obtain the necessary equipment for hearing enhancement systems.
6. Universally recognized symbols/pictograms should be used to replace text, wherever possible. Other symbols should supplement text, but should not be used in isolation. Symbols are an essential aid for people with learning difficulties.
7. A wall mounted or ceiling hung information board should be provided at lift landings, floor level landings of staircases, and at other major decision points (junctions/intersections) in main circulation routes.

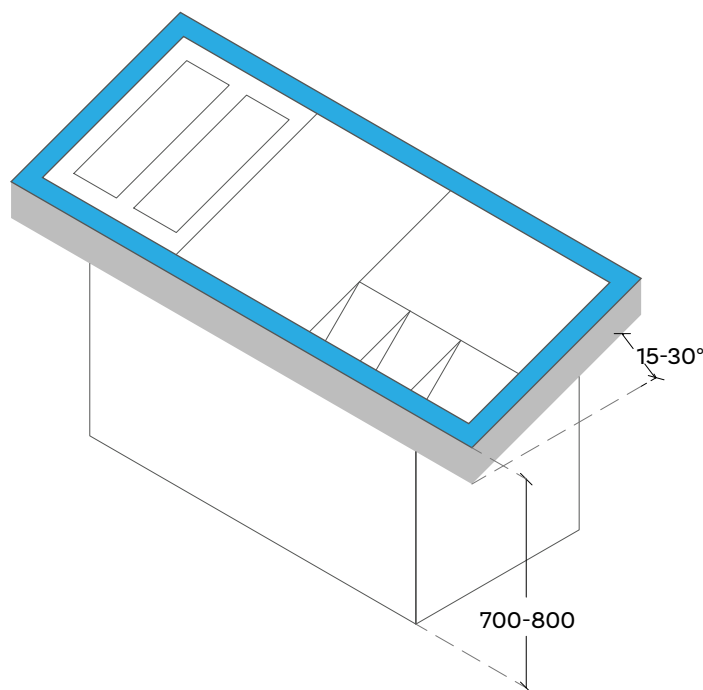


Figure 5.1 Information Display Counter



### 5.2.3 Types of Signage

Depending on the purposes it serves, Signage can be of following types:

- a. Directional
- b. Information
- c. Identification
- d. Instructive or Advisory
- e. Health, Safety & Emergency

#### 1. Directional Sign

Directional signs have a key purpose to provide wayfinding information to navigate in or around a physical environment. Arrow heads with travel routes at specific locations can aid wayfinding for diverse user groups.

#### 2. Information Sign

Information signs help in orientation in a built environment by indicating specific locations in an environment. This includes “You are Here” labels along with

other building identification signs such as zone identification in public buildings or transportation hubs.

#### 3. Identification Sign

Identification Signs are used to display necessary information to users enabling them to identify a specific facility or location in built environments. Example, An accessible washroom facility may be identified by an accessibility sign outside the facility.

#### 4. Instructive or Advisory Sign

Instructive or advisory signs may include signage that provide instructions of diverse types or concerned with human behaviour aspects in built environments.

#### 5. Health, Safety & Emergency Sign

Such signs include signage demarcating equipment for health emergencies or safety issues like fire, etc. Such signage may perform a life saving role in the context of a built environment.



Image 5.2 Directional sign with multi-lingual text and complementing pictograms  
Photo Credits: Dr. Gaurav Raheja





Image 5.3 Emergency exit signage  
Photo Credits: Dr. Gaurav Raheja



Image 5.4 Lift controls integrated with Braille  
Photo Credits: Dr. Gaurav Raheja

Table 5.3 Arrow alignment, typology and hierarchy

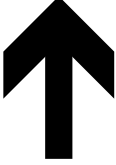
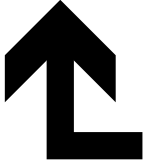





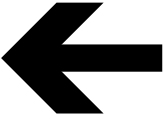
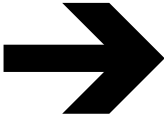
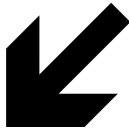
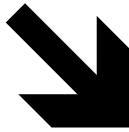

HIERARCHY	ARROWS TO BE ALIGNED ON THE LEFT	ARROWS TO BE ALIGNED ON THE RIGHT
Top of the sign		Straight up 
	 To the left, then ahead	To the right, then ahead 
	 Ahead, then to the left	Ahead, then to the right 
	 Go up on the left	Go up on the right 
	 Turn left	Turn right 
	 Go down on the left	Go down on the right 
Bottom of the sign		Go down ahead 



Image 5.5 Identification signs on the golf cart in the airport  
Photo Credits: Dr. Gaurav Raheja



Image 5.6 Identification signs on airport buggy  
Photo Credits: Dr. Gaurav Raheja





Image 5.7 Instructive signs in the washroom  
Photo Credits: Dr. Gaurav Raheja



Image 5.8 Instructive signs in the toilet  
Photo Credits: Dr. Gaurav Raheja



Image 5.9 Instructive signs at an accessible telephone unit  
Photo Credits: Dr. Gaurav Raheja



Image 5.10 Instructive signs at an accessible drinking water unit  
Photo Credits: Dr. Gaurav Raheja





Image 5.11 Floor signage at a transportation hub  
Photo Credits: Dr. Gaurav Raheja



Image 5.12 Braille sign on handrail bars



### 5.3 Location

Signs should be provided at all sites, campus, developments and buildings in appropriate locations including approaches to building / facility / service, entrance / exit, main lobby or reception, public facilities such as libraries, toilets etc., departments and offices, fire exits and parking and garages.

A good signage scheme should cover all public buildings, spaces, and facilities including transportation infrastructure and should include locations such as :

- a. Approach to building / facility / service
- b. Entrance / exit
- c. Main lobby or reception
- d. Public facilities such as libraries, toilets etc.
- e. Departments and offices
- f. Fire exits
- g. Parking and garages

### 5.4 Visual Comfort and Colour Contrast

#### 5.4.1 Colour Contrast Signs

Contrasting colours should be used to differentiate the figures from the background on the signboard. The commonly employed colours are white for the figure and blue for the background. The colours of the signboard should also contrast with the surrounding surface so as to be clearly distinguishable. The colour combinations red/green and yellow/blue should not be used in order to avoid confusing persons who are colour blind. Avoid using shades of the same colour in the sign and avoid using the same colours as safety signs. The

recommended colour contrast between the letters and background is a 70 point LRV difference.

Information from signs can be conveyed by the colour of lettering and brightness differentials between the letter and background colours. Safety signs use primarily red, yellow and green as information colours. For other signs it is preferable to use Blue and White Colours.

#### 5.4.2 Contrast

Visual contrast is defined as the difference in Light Reflectance Value (LRV) between two contiguous surfaces. Light Reflectance Value is measured on a scale of 0 to 100 where 0 equals black and there is total light absorption and 100 equals white and there is total light reflection. In most circumstances, a difference in these values of 30% is considered adequate. However, research suggests that signs are more legible for the visually impaired when characters contrast with their background by at least 70%.

A simple formula for Visual Contrast is given below:

Visual Contrast =  $[(B1-B2)/B1] \times 100 \%$   
where B1 is LRV of the lighter area and B2 is LRV of the darker area

#### 5.4.3 Basic principles for Colour Contrast

Text should contrast with the background of the sign

- Sign should contrast with the environment
- Light levels (measured in Lux)
- 70% contrast between wall and sign panel
- Avoid shades of colours

Table 5.4 Schedule of Colour Contrast for Signs

BACKGROUND	SIGN BOARD	LEGEND
Red brick or dark stone	White	Black, dark green or dark blue
Light brick or light stone	Black/dark	White or Yellow
Whitewashed walls	Black/dark	White/Yellow
Green vegetation	White	Black, dark green or dark blue
Back-lit sign	Black	White or yellow

- Avoid using same colours as safety signs
- Maximum 5 colours
- Non-reflective surface

#### 5.4.4 Schedule of Colour Contrast for Signs

Schedule for colour contrast with the sign background is given in Table 5.4

#### 5.4.5 Character, Content and Layout

##### 1. Signage Typeface and Style

Sign typefaces must be standard, legible and clearly discernible. Only Sans serif family of fonts are recommended such as Arial, Helvetica Medium, Futura etc. Usage of too many type sizes on any one sign should be avoided. Also italics or script texts should be avoided.

##### 2. Basic principles

- Sans serif font (A sans serif font is a family of fonts that does not have the small feature called “serifs” at the end of strokes. Pixilation makes sans-serif fonts appear cleaner than serif fonts and they are therefore widely used for on-screen text. Common sans serif fonts include: Microsoft Arial, Arial Black, Trebuchet MS, Verdana, etc. Be aware that in some sans-serif fonts capital “l” and lower case “l” will

appear exactly identical (e.g. Arial). Thus use them with caution.)

- Should be mix of Upper and lower case
- Should be Left justified
- Should be Tactile embossed with Braille
- Minimal use of bold
- Consistent font stem widths
- Avoid italics, condensed text, light stems

##### 3. Upper and Lower Case Lettering

- Signs are more effective when they employ both upper and lower case lettering. This is because people recognize “word shapes” rather than literally reading every letter to build up the word and must be left justified.
- The height and boldness of the lettering can be used to indicate the nature of the information that the sign imparts.

##### 4. Line spacing

- The spacing between lines should be 50% of the line height.
- A style should be chosen based on a character width-to-height ratio within 3:5 and 1:1 and the stroke width-to-height ratio between 1:5 and 1:10. It should be consistent for



Image 5.13 Colour contrast on staircase  
Photo Credits: Dr. Gaurav Raheja



each sign.

the size of the lettering increases in proportion to the distance from the reader.

### 5. Pictograms

- Ideally any signage should incorporate a combination of lettering and symbols.
- This will empower persons with Autism, intellectual disabilities and multiple disabilities as well as those with language barriers.

### 6. Positioning the Signage

- Signs should be located where they are clearly visible. A person with low vision may be able to read a sign if they can approach the sign for close up viewing. Wall-mounted signs that contain detailed information, timetables, maps or diagrams, should be centered around 1500mm from the ground, with the bottom edge not less than 900mm from the finished floor level and the top edge up to 1800mm from the finished floor level.
- Braille and tactile signage should be placed at a height between 900 mm to 1500 mm ( ideal location at 1050 mm) above the finished floor level
- Signs should be positioned in a way that the reader does not obstruct circulation paths. Position projecting or ceiling suspended signs above head height at 2300mm from floor level. Although it is important that the sign does not create a head height obstacle, it is equally important that

### 7. Sign Location inside the Building

- Signs should be located where they are clearly visible.
- Top of building directory signage, building direction signage and bulletin board signs should be 1800mm from the finished floor level.
- Room number and identification signage to be at 1500mm from the finished floor level to bottom of the sign, and 50mm from the door frame. In the case of tile walls, the closest horizontal joint should be used.
- Detailed signs and instructions, especially safety notices, should be located at both high and low levels, i.e. at 1600-1700mm and at 1000-1100mm to allow convenient close viewing by wheelchair users.

### 8. Viewing Distances for signage

- Long distance signage include fascia signs, external location, external direction, house numbers
- Medium range includes location + direction, identification signage
- Close range would include room signs, directories, wall mounted information etc.

Table 5.5 Size of signage

VIEWING DISTANCE	SIZE OF SIGNAGE
Up to 7 meters	60 mm x 60 mm
7 meters = 8 meters	100 mm x 100 mm
Exceeding 8 meters	200 mm x 200 mm to 450 mm x 450 mm

Table 5.6 Viewing distance and height of letters

VIEWING DISTANCE	HEIGHT OF LETTERS
2-3 meters	15 mm
6 meters	20 mm
8 meters	25 mm
12 meters	40 mm
15 meters	50 mm
25 meters	80 mm
35 meters	100 mm
40 meters	130 mm
50 meters	150 mm

Table 5.7 Illuminance

**LUX:** Lux is the standard unit of luminance. It is used as a measure of perceived intensity of light. Below are a number of examples of what a variety of lux would correspond to in everyday terms:

Illuminance	Example
1 lux	Moonlight
400 lux	A brightly lit office
400 lux	Sunrise or sunset on a clear day
1000 lux	Typical TV studio lighting
32000 lux	Sunlight on an average day (min)
100000 lux	Sunlight on an average day (max)

**9. Size of Signage**

The width for signage should be standardized. Viewing distance and size of signage, height of letters to be referred from Table 5.5 & Table 5.6

directional signage, maps and text panel is 200 lux.

**10. Size of Letters in Signage**

‘Viewing distance and height of letters are given below in Table 5.6’.

**12. Signage material**

- Signage Material should be non-reflective, preferably matt finish. It should have a non-glare and non-glossy surface. Natural and artificial light should be such so as not to produce glare on the signage surface.
- The material of all signage should be chosen so as to reduce wear and tear and possible damage by vandalism and at the same time easy to maintain. Some suggested materials for signage are wood, acrylic, Aluminum Composite Panel (ACP).

**11. Lighting/ Signage Illumination**

Signs should be well and evenly lit with uniform lighting over the surface of the sign of between 100 and 300 lux. Minimum acceptable level of lighting for

## Komunikaty głosowe

Voice information



Informacja w języku polskim  
Information in Polish



Informacja w języku angielskim  
Information in English



Informacja w języku niemieckim  
Information in Deutsch

## Legenda

Legenda

Tu jesteś  
You are here

Wejście  
Entrance

Słup, przeszkoda  
Column, obstacle

Ścieżka dotykowa  
Guideline

Strefa PKP: Tylko dla personelu  
PKP area: Service staff only

Bramka  
Gate

Kasa biletowa  
Tickets

Schody  
Stairs

Schody ruchome  
Escalator

Winda  
Lift

Informacja  
Turystyczna  
Tourist Information

Skrytka bagażowa  
Luggage lockers

Bankomat  
Cash machine

Biletomat  
Ticket machine

Toaleta damska  
Ladies' toilet

Toaleta męska  
Men's toilet

Toaleta  
dla niepełnosprawnych  
Disabled toilet

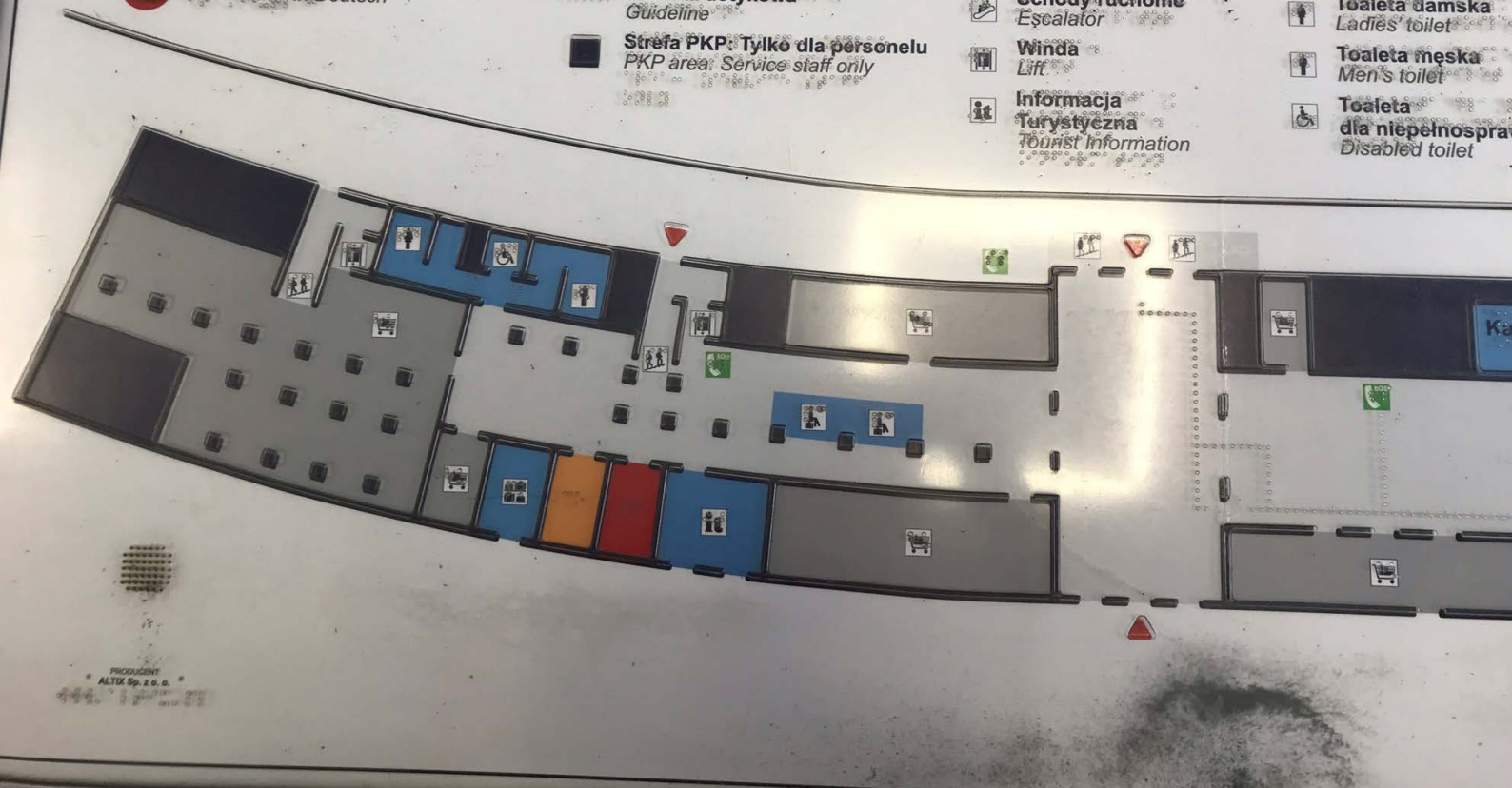


Image 5.14 Braille cum tactile sign board

## 5.5 Tactile and Multi Sensory Information Systems

### 5.5.1 Alternative formats-tactile signs

Common alternative formats can be used to assist people with visual impairments who are best able to interpret information through hearing or touch. Embossed letters, raised pictograms and raised arrows are tactile features that can be incorporated into signs, which can be particularly helpful to persons with visual impairment. It is important to provide both Braille and audio inputs to signage for persons with visual impairments. However, providing only Braille does not

make the signage accessible, as there are a wide range of users to be catered.

### 5.5.2 Braille specification

A system of touch reading for people who are blind or vision impaired that employs raised dots of 0.5mm with a diameter of 1.5mm, evenly arranged with the spacing of 2.5mm in quadrangular letter spaces or cells. Braille symbols are formed within units of space known as Braille cells. A full Braille cell consists of six raised dots arranged in two parallel rows each having three dots. The dot positions are identified by numbers from one through six. Sixty-four combinations are possible using one or more of these six dots. A single cell can be used to represent an alphabet letter, number, punctuation



mark, or a whole word.

### 5.5.3 Maps & Models

- A map or model can be particularly helpful, especially to visually impaired people who may be unable to read signs, and to people with hearing impairments who may not be able to understand verbal directions.
- A tactile map or model is a useful way of providing information to visually impaired people and people with hearing impairments who wish to navigate around a building.

### 5.5.4 Audio Signs/Audio information

- Audible announcements are helpful to most people but particularly to those with visual impairment.
- It is essential that there is a significant difference between the level of background noise and the level of the signal or announcement.
- The higher the signal to noise ratio (the difference in decibels (dB) between signal and ambient) the better for communication.
- People with hearing impairment require at least a +5dB S/N ratio.
- In environments that are noisy, any spoken information should be repeated at least once.
- Audible alarm systems should operate at least at 15dB over the prevailing sound level, with a maximum of 120dB

### 5.5.5 Audio visual signage

- Audio signs - which can play a recorded message when touched or activated by a person's movement or presence. Information can be

provided in various formats, languages or methods of transmission.

### 5.5.6 International Symbol of Accessibility

- The International Symbol of Accessibility must be displayed at all accessible entrances.
- If an entrance is not accessible, directions to an accessible route, including the symbol, must be provided.
- Guidelines must be used for elevators, evacuation and refuge areas, restrooms and bathing facilities.
- Symbols of accessibility are also required to identify volume control telephones, text telephones, and assistive listening systems.
- Colour to be Navy Blue with White lettering, Symbols and Border and size to be 200mm x 200mm square with 1.25mm border.
- The specific pictograms shown in Image: 5.18 are required in certain signage situations

## 5.6 Tactile maps

Tactile maps that offer embossed visual information and acoustic information should be provided when required. Acoustic information shall also be provided when possible.

### 5.6.1 General features

Tactile maps shall include only essential information: location of services and paths and position of elements such as information, main services, toilets, etc.

Concepts used should be easy to understand.

Graphic plane representation (lines, surfaces) should be defined through embossment, textures and colour contrasts.

The signs and lettering of the map shall be represented taking into account contrast between fonts and background colours. The font size shall be at least 20 mm in a sans serif type font. Furthermore, the information shall be represented in Braille.

The maximum dimensions of horizontal fixed tactile maps will be of 800 mm x 450 mm.

The symbols should be clearly

differentiated (form, colour and texture) and shall be easily associated with their representation.

For complex maps buttons providing oral information shall be provided.

### 5.6.2 Location of tactile maps

When a tactile map is provided, it will be located within the accessible path and its location shall be indicated with a tactile orientation and warning surface. It should be in a well-lit area.

Obstacles in front shall be avoided such as glass protections.

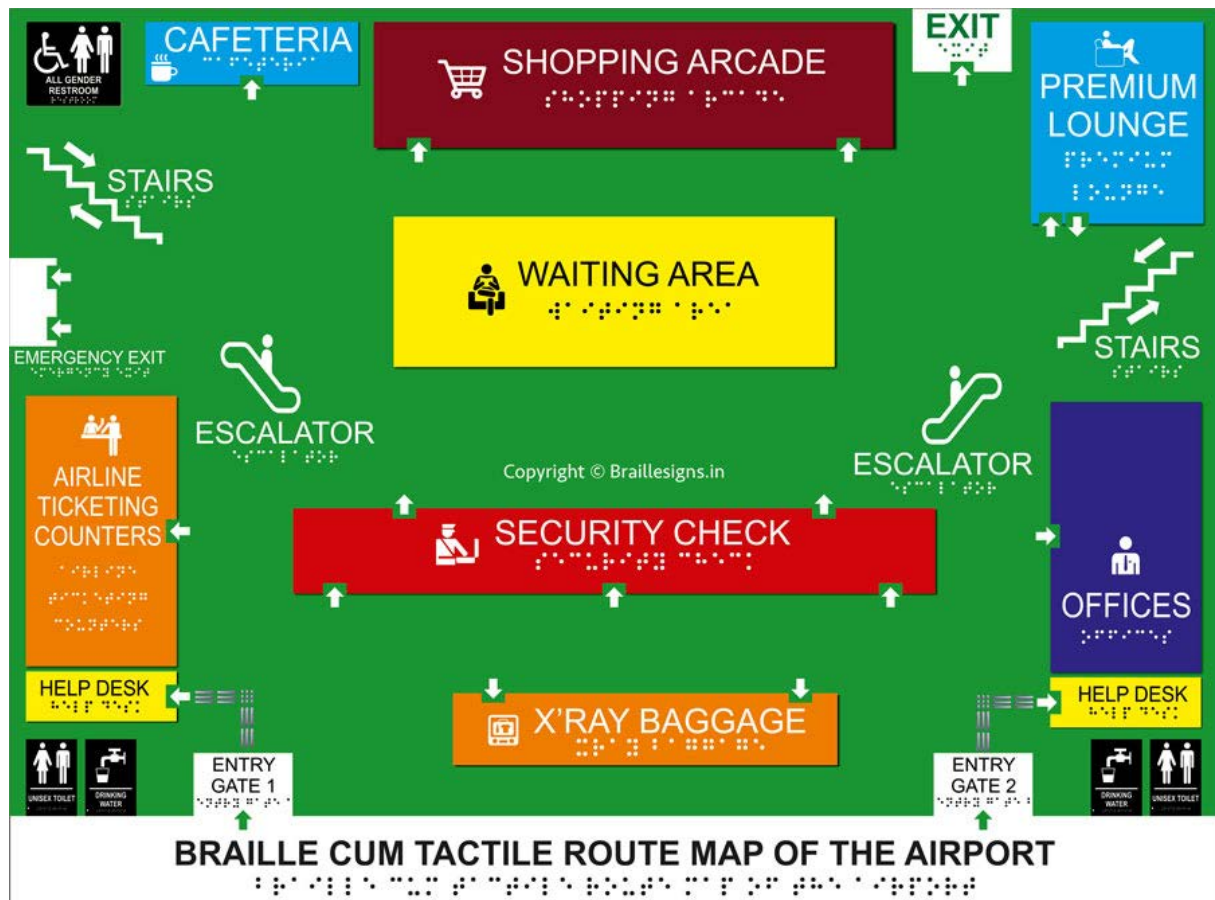


Image 5.15 Braille cum tactile route map

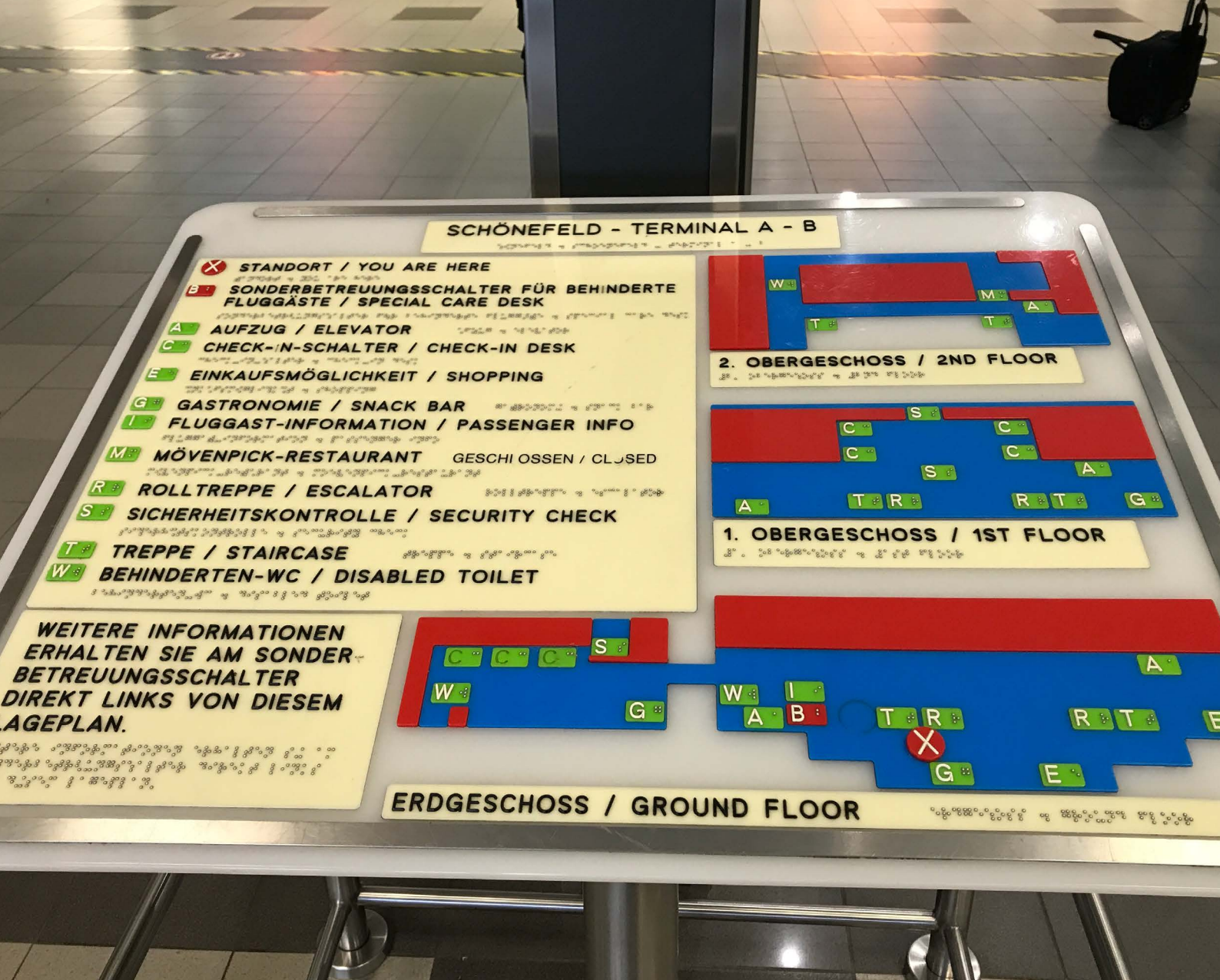


Image 5.16 Braille cum tactile sign board  
Photo Credits: Dr. Gaurav Raheja

When they are mounted in busy public places, they shall include sound information.

In large buildings and open spaces for public use (parks, beaches), they shall be located at the main entrance area, near the door, on the right side, within 1000 mm.

In a building with more than one floor,

it shall be located near the stairs or the elevator.

When fixed to a vertical surface, it shall be centered between 1250 mm and 1750 mm above the floor.

On horizontal or inclined surfaces, the height shall be between 900 mm and 1200 mm from the floor and the inclination preferably will be between 15° to 30° from the horizontal level. (Refer Fig. 5.1)



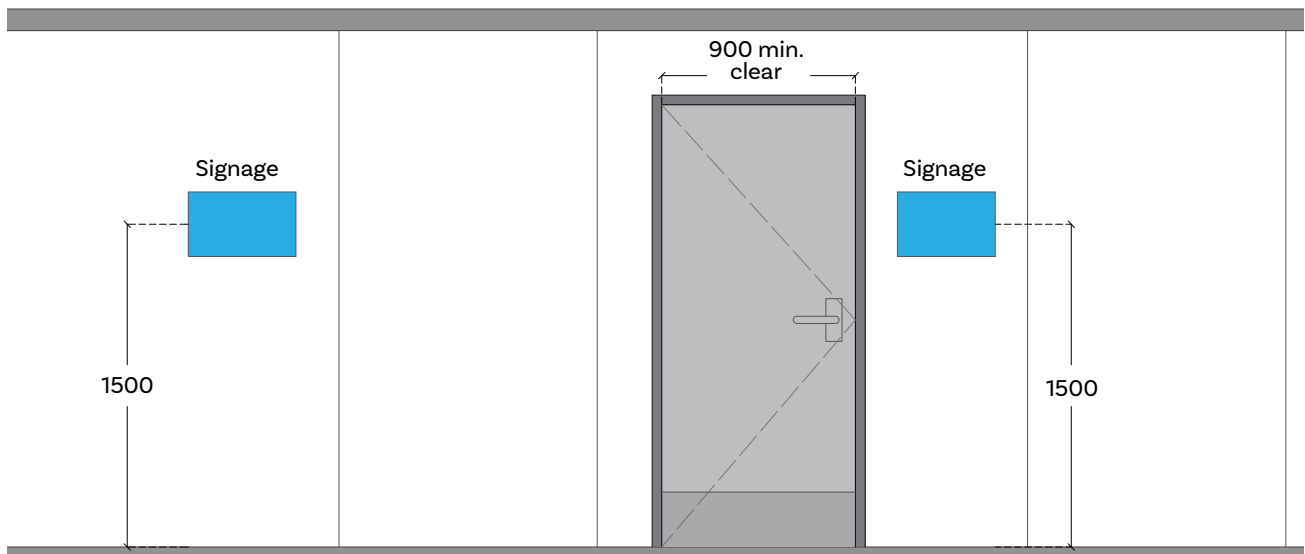


Figure 5.2 Height and placement of signages



Image 5.17 Public toilet signage







Image 5.19 Wayfinding signs on the street: Pune  
Photo Credit: Aishwarya





Image 5.20 Reserved accessible sign in public transport  
Photo Credit: Dr. Gaurav Raheja





Image 5.21 Assembly point sign

Photo Credit: Dr. Gaurav Raheja

A	B	C	D
E	F	G	H
I	J	K	L
M	N	O	P
Q	R	S	T
U	V	W	X
	Y	Z	

Image 5.22 Indian Sign Language

Source: Indian Sign Language Research and Training Centre (ISLRTC) (<http://islrtc.nic.in/>)



अ	आ	इ	ई	उ	ऊ	ए	ऐ	ओ	औ
क	ख	ग	घ	ङ	च	छ	ज	झ	ञ
ट	ठ	ड	ढ	ण	त	थ	द	ध	न
प	फ	ब	भ	म	य	र	ल	व	ळ
श	ष	स	ह	क्ष	ज्ञ	ऋ	ॠ	ॡ	
अं	अः	अँ	,	आँ	एँ	ऽ	।		

Image 5.23 Bharati Braille

Source: <https://avtans.com/2019/11/29/bharati-braille/>



Image 5.24 Priority seating signs  
Photo Credit: Dr. Gaurav Raheja



Image 5.25 Lift priority Signs  
Photo Credit: Dr. Gaurav Raheja

हॉल जी.ए.

HALL GA



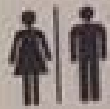
टिकट

TICKET



निकास क्षेत्र

EXIT AREA

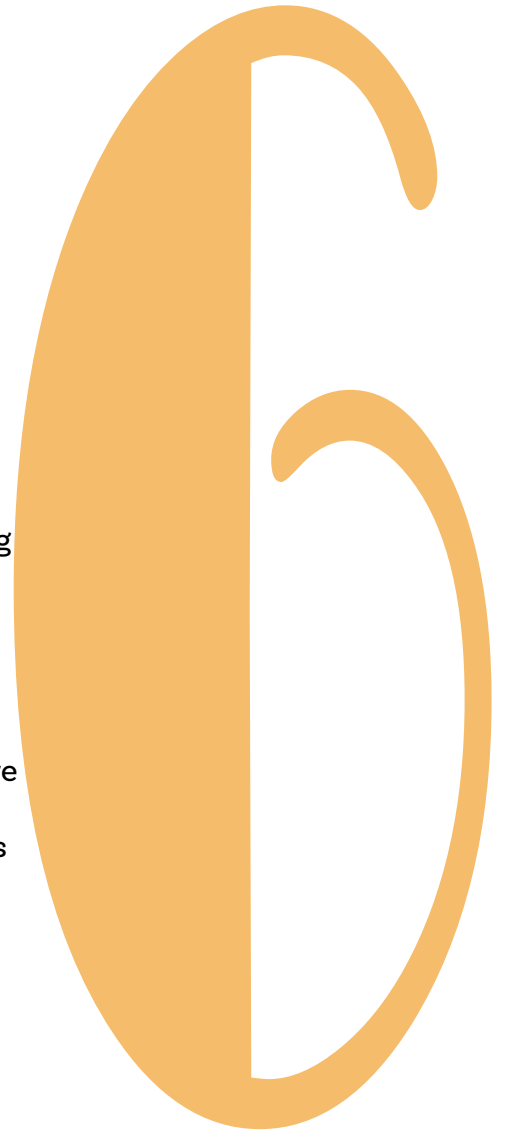






# Building Typologies

- 6.1 Residential Buildings
- 6.2 Education and Research Buildings
- 6.3 Transportation and Supporting Infrastructure Services
- 6.4 Office and Public Buildings
- 6.5 Healthcare Buildings
- 6.6 Retail and Commercial Buildings
- 6.7 Cafeterias, Restaurants and Dining Facilities
- 6.8 Hotels and Hospitality Buildings
- 6.9 Assembly Buildings
- 6.10 Judicial and Legal Buildings
- 6.11 Urban Public Spaces
- 6.12 Sports Buildings and Infrastructure
- 6.13 Religious Buildings
- 6.14 Recreational Buildings and Spaces
- 6.15 Heritage Buildings and Sites
- 6.16 Industrial Buildings
- 6.17 Bank ATMs



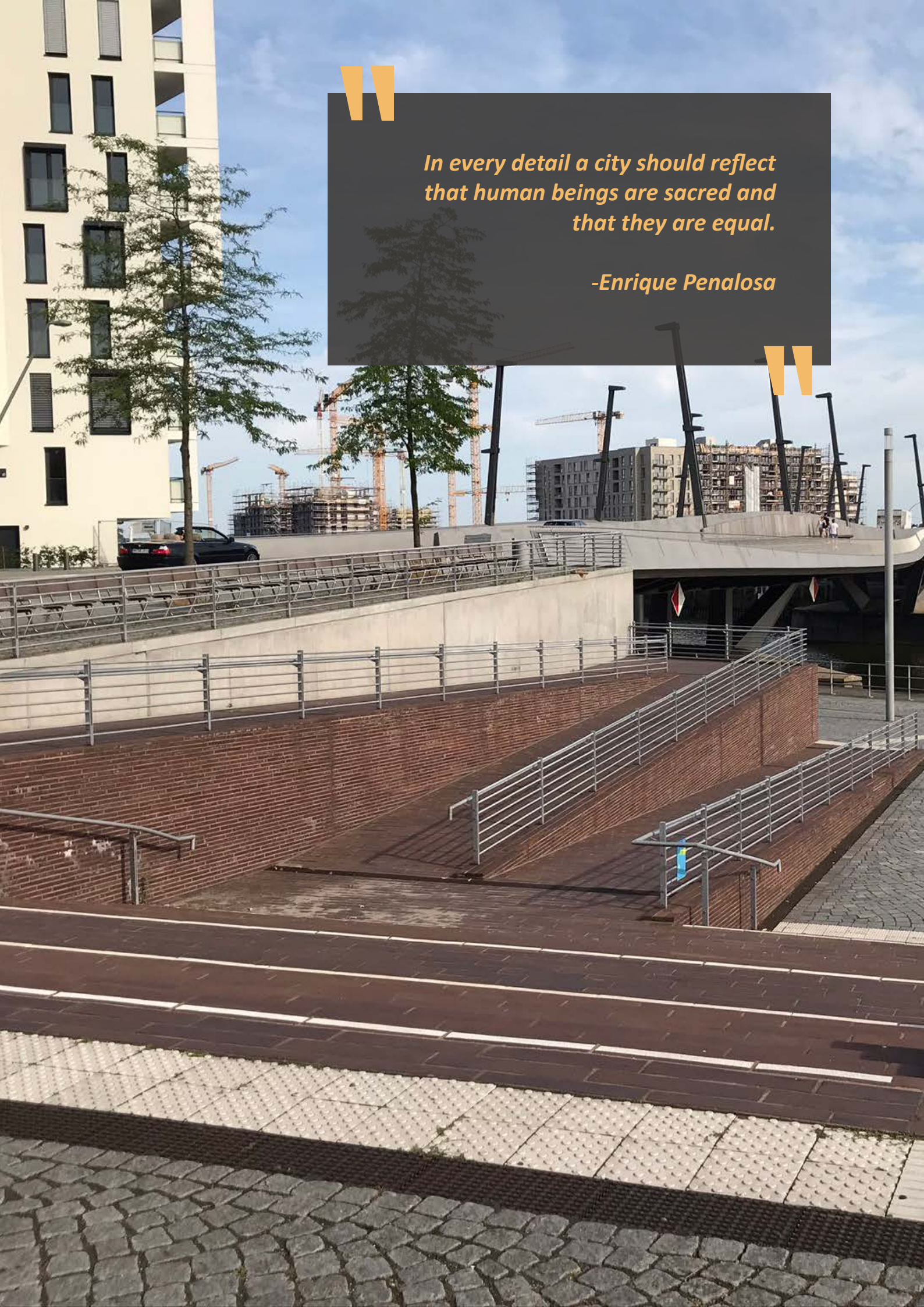


W

*In every detail a city should reflect  
that human beings are sacred and  
that they are equal.*

*-Enrique Penalosa*

W





## 6

## BUILDING TYPOLOGIES

Built environments represent a wide range of building typologies to accommodate functional performance, human participation, and dignity of life to all without any sense of discrimination or posing barriers. It is vital to therefore document the possible building types, even though they may not be limited by the ones below to understand accessibility as a key feature in all. The building typologies must focus on accessibility through external and internal elements along with their day to day management

and maintenance as listed in Chapter 3, 4, 5 and 7. It is reiterated that no new built forms shall be sanctioned for approval or occupancy without prior incorporation of accessibility standards and compliance with them. Table 6.1 presents a broad list of building typologies for accessibility compliances, though not limited to them only. It is to ensure that all infrastructures classified in various building types shall imbibe universal accessibility as a core principle for them.

Table 6.1 Classification of Building Typologies

S. NO.	BUILDING TYPOLOGY	SUB CLASSIFICATION
1.	Residential Buildings	Public housing including low income housing, Apartments, Independent Housing/ Builder Floors, Group Housing, Gated communities, Old Age Homes, Youth Hostels, working women/men hostels, Dharamshalas, Co-living spaces, etc.
2.	Education & Research Buildings	Primary Schools, Secondary Schools, High Schools, Public or Private Institutions, Colleges, Universities, Coaching Centres, Skill Development Centres, Vocational Training Centres, Research Laboratories, etc.

S. NO.	BUILDING TYPOLOGY	SUB CLASSIFICATION
3.	Transportation and Supporting Infrastructure Services	Pedestrian and Bicycle Mobility Infrastructure, Car parking including Multi-level and surface parking, Non Motorised Transportation (NMT), Infrastructure for Electric-Mobility, Paratransit systems like E-rickshaws, Auto-rickshaws, taxi services (App based, Pre-paid,etc.) Public Transportation like Buses (BRTS, MRTS), Multi-modal transit system, Surface Transport (Road, Bus Terminus/ISBTs), Rail Transport (Railway Station and related infrastructure), Air Transport (Airports, Airplane), Water Transport (Boat Jetty, Cruise, etc.), Ropeways, Subways and Over Bridge, etc.
4.	Office and Public Buildings	Government Office Buildings, Corporate Office Buildings, Banks and Financial Office Buildings, Bank ATMs, IT Offices, Corporate Parks, Private Offices, Income Tax offices / Customs offices, Secretariats, Passport offices, Election centers and Polling Booths/ stations, Public Libraries, etc.
5.	Healthcare Buildings	Hospitals - Primary, Secondary and Tertiary Care, Medical/Dental Colleges, Ayurvedic Colleges, Ayurvedic Pharmacy, Homeopathy Medical Colleges, Neighbourhood Clinics & Polyclinics, Diagnostic Centres, Nursing Homes, Mental Healthcare Facilities, Hospice, Facilities for terminal illness, Rehabilitation Centres - all kinds, Sub-Centre, Primary Health Centre, Community Health Centre, Medical kiosks and Portable medical facilities, etc.
6.	Retail and Commercial Buildings	Local Grocery Stores, Local Shopping centres, Community shopping centres, Local Bazaars, Mandis and Haats, Department Stores, Supermarkets & Hypermarkets, Shopping Malls, Wholesale markets and retail, Showrooms for Vehicles, Emporiums, etc.
7.	Cafeteria, Restaurant and Dining Facilities	Cafeterias, Restaurants, Food Courts, Fast Food outlets, Canteens in diverse building typologies, Mess and Dining Halls, Bars and Pubs, Other Food and Beverage facilities in diverse building types, Langar halls, Congregational Dining facilities, etc.
8.	Hotel & Hospitality Buildings	Guest Houses/ Inns, Lodge, Rest houses, Motels, Hotels - all categories, Lodging for Youth (Hostels), Ashrams and Dharamshalas, etc.
9.	Assembly Buildings	Parliament building, Town Halls, Senate Halls, State Assembly Buildings, Lecture Halls, Cinema Halls, Multiplexes, Performance theatres, Opera Auditoriums/ Convention centers, etc.

S. NO.	BUILDING TYPOLOGY	SUB CLASSIFICATION
10.	Judicial and Legal Buildings	Tehsil, Registrar office, Sessions Court, District Court, High Court, Consumer Court, Supreme Court, Court chambers / Lawyer Chambers, Legal Offices Police Stations, Prisons, Temporary holding cells, etc
11.	Urban Public Spaces	Community Parks, Gardens, Riverfront Developments, Riverside Ghats, Lakeside Developments, Beaches, Public Spaces like plazas, markets places etc., Streets, Cemeteries and Crematoriums, Recreational Clubs, Open Air Theatres, National Parks, etc.
12.	Sports Buildings and Arenas	Sports Arenas, District Sports complexes, Gymnasiums, Stadiums, Neighbourhood Gyms, Swimming Pools, Indoor Sports complex, etc.
13.	Religious Buildings and Sites	Temples, Mosques, Churches, Gurudwaras, Monasteries, Synagogues, Prayer Rooms, Meditation Centres, etc.
14.	Recreational Buildings and Spaces	Museums, Art Galleries, Concert Arenas, Amusement Parks, Cultural Centres, Arenas, Temporary Pandals, etc.
15.	Heritage Buildings and Sites	Historical Monuments, Historical Sites, Adapted Buildings, interpretation centres, ancillary services/ facilities, etc.
16.	Industrial Buildings	Factories, Workshops, Cottage Industries, Small and Medium scale Industries, Heavy Industries, Warehouses, Manufacturing Units, IT and ITES Sectors, etc.

Universal accessibility as an experience in built environments can only be achieved through an integrated approach of combining information access with built infrastructure access and human sensitisation for delivery of services. Else, it will only serve a spatial experience. For example, a building with an accessible ramp and an accessible washroom may still remain inaccessible to several users, if it does not have an adequate entrance or doorway incorporating access for wheelchair manoeuvring or others. These guidelines advocate and strongly recommend all built environments to enhance accessibility levels in each building whether existing or new and orient the infrastructure building practices towards a best practice approach on universal

accessibility. It is reiterated that these Harmonised Guidelines and Standards for Universal Accessibility require to be read in conjunction with the guidelines or standards for diverse built environments as issued by their respective Ministries or regulating bodies. This includes various guidelines or standards like NBC, IRC Codes, URDPFI guidelines, UTIPEC guidelines, etc. among others.

However, under any circumstance, there shall be no compromise to the minimum recommendations for accessibility as stated in Table 6.2. The idea and spirit of minimum standards should not be treated with complacency. It rather provides a level of non negotiable aspects of built environment for creating inclusive urban infrastructures.



Table 6.2 Minimum Accessibility Provisions in Different Building Occupancies  
Adapted from NBC, 2016

S.NO.	CATEGORY	MINIMUM COMPLIANCE FOR ACCESSIBILITY
1	Residential Buildings	<p>a.All common and communal areas, such as, approach, entrances/exits, lifts, stairs, lobbies, clubs, religious facilities, parking, sports facilities/parks and recreation areas, etc, and associated sanitary and other facilities therein.</p> <p>b.5 percent houses must be accessible meeting accessibility requirements, preferably on ground floor. This shall also be supported by an appropriate allotment policy.</p> <p>c.In all other 95 percent houses, minimum universal design features, such as, minimum clear door widths of : main entrance, rooms, kitchen and that of at least one toilet and sanitary room in each house along with bedroom.</p> <p>d.Such a toilet and sanitary room in the house shall be the one having access from the living/drawing room and their size shall comply with those given in Section 4.9 to allow the occupants to adapt to their needs to facilitate ageing-in-place and disabled friendly environment.</p> <p>e.Accessibility to open spaces for play and recreation for children, elderly and others with special needs.</p> <p>f. All housing shall be designed and implemented with a concept of adaptability. Such that the various spaces and elements could be retrofitted for adaptive functions as per the needs of persons with disabilities, elderly, persons with vulnerable health conditions,etc.</p>
2	Education & Research Buildings	<p>a.Parking areas, access routes, main entrances of all buildings, reception spaces, circulation spaces in both external and internal environments</p> <p>b.All teaching/administrative and common areas - learning spaces, classrooms, auditoriums (assembly areas) frequented by staff/students</p> <p>c.Laboratories, equipment and facilities</p> <p>d.Furniture layouts and specifications</p> <p>e.Accessible technologies for enhancing learning accessibility in classrooms</p> <p>f. Play and recreational areas</p> <p>g.Internal and external sanitary provisions along with drinking water provisions</p>

S. NO.	CATEGORY	MINIMUM COMPLIANCE FOR ACCESSIBILITY
		<p>h. Administrative Offices and staff rooms</p> <p>i. Libraries with open book stacks. Few enclosed rooms/ cubicles in the library for those with hearing and vision impairments who may need assistance while reading.</p> <p>j. Dining facilities including canteens, mess, etc.</p> <p>k. Emergency evacuation routes and assembly points</p>
3	Transportation and supporting Infrastructure Services	<p>a. All public areas within the transportation facility premise and interchange facilities including parking, drop off and boarding areas, cloak rooms, enquiry offices, custom areas, banks and bank ATMs, ticket counters, booking halls and counters, waiting areas, vending machines, eateries, etc.</p> <p>b. Wayfinding and Information Signs in accessible formats (For eg. Braille format)</p> <p>c. Public address / Announcement systems with appropriate acoustic environments</p> <p>d. Tactile guiding systems from drop off points to all service areas till the point of boarding</p> <p>e. Accessible streets, crossings, sidewalks, bus shelters, railway platforms, boat jetties, etc.</p> <p>f. Accessible horizontal and vertical circulation</p> <p>g. Transportation vehicle systems like Low Floor Buses, Train coaches, etc.</p> <p>h. Prayer room(s) wherever applicable</p> <p>i. Accessible Drinking water facilities</p> <p>j. Accessible Sanitary provisions with family friendly washrooms including baby changing stations</p> <p>k. Emergency evacuation routes and assembly points</p>
4	Office and Public Buildings	<p>a. Parking and drop off areas</p> <p>b. Office entrances, reception counters and waiting areas</p> <p>c. Accessible Horizontal and vertical circulation systems including corridors, aisle widths, staircase, ramps, lifts, etc.</p> <p>d. Accessible furniture systems with Flexible Layouts and ergonomic design</p> <p>e. Accessible workstations</p>

S. NO.	CATEGORY	MINIMUM COMPLIANCE FOR ACCESSIBILITY
		<ul style="list-style-type: none"> <li>f. Accessible Drinking water provisions</li> <li>g. Accessible Sanitary provisions with lactation rooms</li> <li>h. Cafeteria and Dining Facilities</li> <li>i. Emergency evacuation routes and assembly points</li> </ul>
5	Healthcare Buildings	<ul style="list-style-type: none"> <li>a. Parking areas, building entrances, registration counters, dispensary counters, waiting spaces, etc.</li> <li>b. All public areas to be accessible, including OPDs, IPDs, wards, toilets, changing rooms, sample collection rooms, x-ray rooms, patient examination rooms, medical distribution rooms/centres.</li> <li>c. Accessible horizontal and vertical circulation systems including corridors, aisle widths, staircase, ramps, lifts, etc.</li> <li>d. Accessible drinking water provisions</li> <li>e. Accessible sanitation provisions</li> <li>f. Emergency evacuation routes and assembly points</li> </ul>
6	Retail and Commercial Buildings	<ul style="list-style-type: none"> <li>a. Parking areas and drop offs</li> <li>b. Waiting areas</li> <li>c. Shop fronts, counters and aisle widths</li> <li>d. Wayfinding and Information Signs in accessible formats (For eg. Braille format)</li> <li>e. Accessible Horizontal and vertical circulation systems including corridors, aisle widths, staircase, ramps, lifts, etc.</li> <li>f. At least one changing room</li> <li>g. Accessible drinking water provisions</li> <li>h. Accessible sanitary provisions</li> <li>i. Emergency evacuation routes and assembly points</li> </ul>
7	Cafeteria, Restaurant and Dining Facilities	<ul style="list-style-type: none"> <li>a. Parking areas and drop offs</li> <li>b. Waiting areas</li> <li>c. Accessible horizontal and vertical circulation systems including corridors, aisle widths, staircase, ramps, lifts, etc.</li> <li>d. Accessible seating areas and furniture to be provided in accordance with Section B-15 of NBC, 2016</li> </ul>



S. NO.	CATEGORY	MINIMUM COMPLIANCE FOR ACCESSIBILITY
		<p>e.Accessible drinking water provisions</p> <p>f. Accessible sanitation provisions</p> <p>g.Emergency evacuation routes and assembly points</p>
8	Hotel and Hospitality Buildings	<p>a.Parking areas and drop offs</p> <p>b.Entrances, Reception counters and waiting areas</p> <p>c.Minimum five percent of the total rooms including their toilet room, shower room, balcony, etc, shall be accessible and preferably be provided on the ground floor for ease of evacuation in case of an emergency.</p> <p>d.All other rooms shall have universal design features (without specific adaptations like handrails/ grab bars, etc). This would include minimum clear door widths of 900 mm of all entrances including those of sanitary rooms and balcony areas; and minimum passage width of 1200 mm in the rooms and required turning radius.</p> <p>e.In accommodations having more than one toilet/ sanitary room, one such facility shall be accessible.</p> <p>f. In case of accessible accommodations, a choice of right or left hand transfer to the toilet and shower shall be provided.</p> <p>g.Wayfinding and Information Signs in accessible formats (For eg. Braille format)</p> <p>h.Emergency evacuation routes and assembly points</p> <p>i. For all hospitality systems, especially resorts and independent cottage/ villas, it is vital to ensure that family friendly facilities are provided for people with disabilities, children feeding mothers, elderly and any other functional limitation. Planning design, and detailing to ensure that congregational/ community facilities of a hospitality of togetherness is not compromised for inclusivity for example, family rooms, collective dining, recreational spaces etc</p>
9	Assembly Buildings	<p>a.Parking areas and drop offs</p> <p>b.Entrances and waiting areas</p> <p>c.Horizontal and Vertical circulation spaces including aisle widths, stage areas, green rooms, etc.</p>

S. NO.	CATEGORY	MINIMUM COMPLIANCE FOR ACCESSIBILITY
		<p>d.Wayfinding and Information Signs in accessible formats (For eg. Braille format)</p> <p>e.Hearing enhancement systems with appropriate acoustics</p> <p>f. Accessible audio visual systems with alternative communication support for persons with hearing impairments and visual impairments.</p> <p>g.Accessible seating spaces to be as per Section B-12.3 of NBC, 2016</p> <p>h.Food kiosks / outlets</p> <p>i. Accessible drinking water provisions</p> <p>j. Accessible sanitation provisions</p> <p>k.Emergency evacuation routes and assembly points</p>
10	Judicial and Legal Buildings	<p>a.Parking areas and drop offs</p> <p>b.Entrances and waiting areas</p> <p>c.Horizontal and Vertical circulation spaces including aisle widths, stage areas, green rooms, etc.</p> <p>d.Wayfinding and Information Signs in accessible formats (For eg. Braille format)</p> <p>e.Court rooms</p> <p>f. Hearing enhancement systems with appropriate acoustics</p> <p>g.Accessible audio visual systems with alternative communication support for persons with hearing impairments and visual impairments.</p> <p>h.Legal offices, Lawyer and Judge chambers</p> <p>i. Accessible seating spaces</p> <p>j. Accessible drinking water provisions</p> <p>k.Accessible sanitation provisions</p> <p>l. Emergency evacuation routes and assembly points</p>
11	Urban Public Spaces	<p>a.Parking areas and drop offs</p> <p>b.Entrances and Waiting areas</p> <p>c.Accessible interchange facility for transit systems</p> <p>d.Horizontal and Vertical circulation spaces including external access routes, plazas, aisle widths, staircases, elevators, etc.</p>

S. NO.	CATEGORY	MINIMUM COMPLIANCE FOR ACCESSIBILITY
		<p>e.Wayfinding and Information Signs and Maps in accessible formats (For eg. Braille format)</p> <p>f. Accessible street furniture including seating spaces</p> <p>g.Food outlets and kiosks</p> <p>h.Accessible drinking water provisions</p> <p>i. Accessible sanitation provisions</p> <p>j. Emergency evacuation routes and assembly points</p>
12	Sports Buildings and Arenas	<p>a.Parking areas and drop offs</p> <p>b.Entrances and Waiting areas</p> <p>c.Horizontal and vertical circulation spaces including external access routes, plazas, aisle widths, staircases, elevators, etc.</p> <p>d.Wayfinding and Information Signs and Maps in accessible formats (For eg. Braille format)</p> <p>e.Spectators seating areas for wheelchair users as per Section B-12.3 of NBC, 2016</p> <p>f. Accessible drinking water provisions</p> <p>g.Accessible sanitation provisions</p> <p>h.At least one accessible changing room and an accessible shower room must be provided in every sports complex and arena inclusive for all genders.</p> <p>i. Sports halls, administration and common areas</p> <p>j. Emergency evacuation routes and assembly points</p>
13	Religious Buildings and sites	<p>a.Parking areas and drop offs</p> <p>b.Entrances and Waiting areas</p> <p>c.Horizontal and Vertical circulation spaces including external access routes, plazas, aisle widths, staircases, elevators, etc.</p> <p>d.Accessible prayer halls, congregation spaces and other common areas.</p> <p>e.Wayfinding and Information Signs and Maps in accessible formats (For eg. Braille format)</p> <p>f. Accessible seating / resting spaces</p> <p>g.Accessible drinking water provisions</p> <p>h.Accessible sanitation provisions</p> <p>i. Emergency evacuation routes and assembly points</p>



S. NO.	CATEGORY	MINIMUM COMPLIANCE FOR ACCESSIBILITY
14	Recreational Buildings and Spaces	<ul style="list-style-type: none"> <li>a. Parking areas and drop offs</li> <li>b. Entrances and Waiting areas</li> <li>c. Horizontal and Vertical circulation spaces including external access routes, plazas, aisle widths, staircases, elevators, etc.</li> <li>d. Wayfinding and Information Signs and Maps in accessible formats (For eg. Braille format)</li> <li>e. Accessible seating spaces</li> <li>f. Accessible drinking water provisions</li> <li>g. Accessible sanitation provisions</li> <li>h. Emergency evacuation routes and assembly points</li> </ul>
15	Heritage Buildings and Sites	<ul style="list-style-type: none"> <li>a. Reasonable access to all public areas without affecting the historical character of the building.</li> <li>b. Alternative solutions and innovative methods that do not conflict with conservation/preservation requirements should be explored.</li> <li>c. Accessible information through technology and alternative formats (braille, tactile, multi lingual, sign language, etc.)</li> <li>d. Accessible seating spaces</li> <li>e. Accessible drinking water provisions</li> <li>f. Accessible sanitation provisions</li> <li>g. Emergency evacuation routes and assembly points</li> </ul>
16	Industrial Buildings	<ul style="list-style-type: none"> <li>a. Parking areas and drop offs</li> <li>b. Entrances and Waiting areas</li> <li>c. Horizontal and Vertical circulation spaces including, aisle widths, staircases, elevators, etc.</li> <li>d. Wayfinding and Information Signs and Maps in accessible formats (For eg. Braille format)</li> <li>e. Accessible work spaces and controls</li> <li>f. Accessible cafeteria and dining facilities</li> <li>g. Accessible healthcare / First aid</li> <li>h. Accessible drinking water provisions</li> <li>i. Accessible sanitation provisions</li> <li>j. Emergency evacuation routes and assembly points</li> </ul>

It is extremely crucial for each building typology to invest in accessibility to make a seamless experience possible for people with diverse abilities, age or gender and participate equally in various activities and functions of life.

## 6.1 Residential Buildings

Residential built forms include structures built for sheltered living, housing, etc. They may be classified as independent houses, multi storey apartments, gated communities, affordable housing, old age homes, private plotted housing, residential hostel buildings, studio apartments, etc. The key features for accessibility in a housing context include access to parking, elevators, staircases, shared spaces, entrances and other functional aspects as specified in terms of shared facilities.

The Residential sector needs to cater to universal accessibility experiences for all, ensuring accessibility to diverse types of families within the Indian context. A typical family unit is uniquely diverse with age, gender, and abilities along a life span. Residential planning and designs therefore need to imbibe adaptive qualities, meeting accessible features with changing times.

Provision of various adaptive features in housing spaces can render them accessible for all times. In addition to the guiding principles mentioned in Chapter 2, housing planning and design must also integrate an additional principle of “**visibility**”. This principle implies that housing units should at least make minimum provisions for spaces like house entrances, living rooms and at least one washroom to be fully accessible and adaptable to accommodate family members or guests with special needs. These minimum requirements shall in

no way prevent the idea of incorporating accessibility and inclusion in all other aspects of residential building design and its surrounding environments.

Needless to say, that residential facilities designed for special groups like elderly, etc. shall require to have heightened levels of access and support built into the design, while it is recommended to design housing and residential accommodations with sensitivity, keeping in mind aging, motherhood, temporary injuries, health disorders and presence of disabilities among members of family. To make residential spaces accessible, the following recommendations must be considered for implementation.

### 6.1.1 Exterior Spaces

1. The exterior spaces and elements shall ensure seamless mobility for pedestrian and wheeling devices alongwith level crossings and gradients for everyone.
2. The surface material shall be non slip and smooth to support walkability with baby strollers, wheelchairs, walking sticks, crutches, etc.
3. The driveway / drop off / parking area should provide easy access to the house by means of a walkway that is uniform level and free of cracks and uneven surfaces.
4. The approach route should have a hard, non-slip and even surface. There shall be no discontinuity in the travel path by the presence of steps or sudden changes in level and other obstructions like manholes covers, light poles etc.
5. In case of level differences at the entrance of the building/ residential unit, it should be made accessible to all user groups by providing a ramp with handrails, platform lift or an elevator as applicable.



Image 6.1 Accessible green areas  
Photo Credits: Dr. Gaurav Raheja

6. For multistoried buildings, all floors should be connected by lifts large enough to accommodate wheelchairs, baby strollers and other assistive devices. The lift lobby should have level and non-slip surfaces.
7. Each floor number must be clearly indicated in the lift lobby as part of the wayfinding design. The lobby should also incorporate the following for easy accessibility to
  - a. List of names of apartment owners against the apartment numbers.
  - b. A wayfinding map indicating common spaces in the society/ building.
  - c. An egress plan to be referred in case of emergencies.
8. All exterior spaces shall be well lit and

should have glare free surfaces.

9. In case access card readers or other identification sensors are used for security reasons, the sensors should be mounted at the maximum height of 1200 mm.
10. The access to common spaces such as the garbage chute, metering locations, etc. shall have easy access with no level differences.

### 6.1.2 Entrances

1. Entrances should be well lit and be provided with an adequate cover from adverse weather conditions.
2. The control switches (lights and doorbells) shall be placed at a height of 1200 mm from the finished floor level.





**Image 6.2** Accessible ramp at the entrance of an apartment building  
*Photo Credits: Shreya Shetty*

3. There can be provision of choices for door opening mechanisms like lever type door handles with integrated lock mechanisms or technologically advanced keyless door locks which do not require the turning of a key but can be operated with the use of passcodes, RFID cards, simple remote control or via smartphones. These possibilities, which enhance contextualization, will be helpful to Persons with Disabilities and elderly persons who have difficulty in operating keys and keeping track of them.
4. For wheelchair users, the entrance should have a platform of at least 1500 mm x1500 mm. This will enable a person to rest and prepare for entry.
5. The door mat should be flushed with the finished floor level and not create a level difference which acts as a

barrier for a wheelchair user, rollators used by the elderly, for use of baby prams and luggage trolley etc.

### **6.1.3 Living Room**

1. There should be a turning space of at least 1500 mm diameter near all entry points to the living room.
2. A living-dining combination is preferable to a kitchen-dining combination (except when the wheelchair user does the cooking).
3. The seating space for a wheelchair user at the dining table should provide clear knee space. Clear knee space for a wheelchair user should be at least 900 mm wide, 480 mm deep and 750 mm high.
4. There should be a clear floor space for

the wheelchair of at least 900 mm × 1200 mm in front of all the fixtures.

5. Chair seat heights should not be less than 500 mm, however, there should be appropriate seating furniture for diverse disabilities in the house.
6. Controls and operating mechanisms shall comply with Section 4.15.
7. Homes with cultural preference of Indian squat latrines in WCs shall include grab rails as an adaptive measure in case there is a need for retrofitting at a later stage.

#### 6.1.4. Washrooms

1. At least one washroom to be directly accessible from the living room for visitors or guests with special needs.
2. The entry to the accessible washroom should be minimum 900 mm wide.
3. The washroom must have provisions to enable adaptability of accessible features like grab rail installation, shower seat installation along with lever type faucets.
4. It is recommended to avoid countertop basins instead of basins with knee clearance space.
5. Flooring inside washrooms shall be non slippery and shall maintain adequate colour contrast with the interior environment.
6. For family members or guests with high support needs or senior age, it is recommended to have an emergency alarm cord, within operable height range in the washroom.
7. Lever type door lock is preferred. However, if not possible, the door latch/lock system should be provided at two heights (between 800 - 1100mm) to accommodate individuals with reach limitations.
8. The washroom design should comply

with Section 4.9 with the possibility of customization ensuring accessibility at all times.

9. Washrooms in residential environments must have features and qualities adaptable to the dynamic and changing requirements of family needs along life span requirements.

#### 6.1.5 Kitchen

1. Accessible kitchens imply features with adequate mobility clearances, reachability to counter tops and shelving arrangements and safe interior environments for diverse users in home environments.
2. For kitchens to be inclusive, they need to have adaptive features so as to accommodate customization for diverse cooking practices and cultures from India and beyond.
3. Residential kitchens especially in mass housing projects need to ensure adaptability to diverse cultural practices to support cultural inclusion.
4. Wheelchair turning diameter of at least 1500 mm should be provided between the counter and the opposite walls.
5. Floor surface should allow for easy wheelchair maneuverability.
6. Counter tops should be between 750 mm and 800 mm in height and provide clear knee space for a wheelchair user. Clear knee space for a wheelchair user is at least 900 mm wide, 480 mm deep and 750 mm high.
7. Provision of toe space which is 150mm deep and 230mm high shall be made at the base of the cabinets.
8. Counter tops/slabs should have rounded or chamfered edge profile.
9. All surfaces should be smooth to

facilitate sliding of heavy items from one area to another.

10. Slide-out working spaces are useful in providing an over-the lap working surface.
11. Shelves and storage spaces should be between 300 mm and 1200 mm from the floor surface.
12. Special Hydraulic hardware system can be incorporated in the kitchen cabinet design which facilitates easy operation of drawers or cabinets such as –
  - a. Wall pull down system allows wall cabinets to move downwards and outwards, thereby making even high cabinets easy to reach. This is very helpful to reach higher cabinets which are mostly out of reach for children and people of shorter height range. It is also helpful to elderly people and people with disabilities.
  - b. One touch wall cabinet which uses a battery-operated, touch sensor amplifier. With the slight tap and a touch of a button, the wall cabinet should open and close smoothly. This makes the mechanism effortless and can be used by a wide range of user groups including elderlies and Persons with disabilities.
  - c. Pull out shelves which makes it possible to reach the rear spaces of a cabinet.
13. Task lighting is recommended at the kitchen counter which avoids shadows and gives sufficient illumination for kitchen to carry out kitchen work.
14. Lever type faucets should be installed in the kitchen which is easily usable by most user groups and requires minimum effort.

15. For people with ambulatory disabilities, stools (preferably with back and footrests) should be provided strategically at the main work area.

#### **6.1.6 Bedroom**

1. The bedroom should provide 1500 mm turning space for wheelchair users, at least near all the doors.
2. Bed for a wheelchair user should:
  - a. Have a height of 450 - 480 mm from the floor surface.
  - b. The bed should be sturdy and stable. The stability may be improved by placing the bed against a wall or in a corner of the room (except if the wheelchair user makes the bed).
  - c. Be positioned to provide at least a 1500 mm turning in space at the transfer side.
3. A bedside table or cabinet at a height of 450 mm to 900 mm from the floor may be useful to hold a lamp, telephone/mobile phone, necessary medications, and a call bell if assistance is needed.
4. Wall hook installed at a height of 1100 mm to 1300 mm may be a useful addition to the closet area.
5. The closet should:
  - a. Have a clear floor space of at least 900 mm × 1200 mm.
  - b. Have the clothes bar at a height of 1200 mm from the floor.
  - c. Have shelves installed at various levels between 300 mm and 1200 mm from the floor surface.
6. Lever type door handle should be provided.



### 6.1.7 Furniture Layout and Interior Details

1. Residential interiors including furniture shall follow the principle of adaptability and safety while planning or executing interiors in home spaces.
2. It is recommended that clear circulation routes of at least 900 mm are maintained in home environments for people with special needs. There should be sufficient room to manoeuvre wheelchairs (a turning diameter of at least 1500 mm) or assistive devices such as walkers, rollators or a white cane and baby pram.
3. The furniture layout should not restrict access to electrical outlets, telephones, LAN connection and wall switches.
4. A clear floor space for the wheelchair, of at least 900 mm × 1200 mm should be provided in front of all the utilities and furniture.
5. Furniture corners to ensure smooth or rounded edges for safe maneuvering through them.
6. For balconies less than 900 mm wide, sliding doors may be preferred.
7. Wherever possible, balcony doors shall be flushed with the floor level. When a raised threshold is necessary, it shall have a maximum height of 20 mm and be bevelled down to a height of 10 mm chamfered.
8. Knurled surface door handles should be used on interiors of dwellings frequented by people with visual impairments. These abrasive, knurled surfaces indicate that the door opens to a hazardous area and alerts the individual to danger.
9. Glass doors should be marked with a bright coloured motif at eye level to aid people with low vision.
10. In case of any level difference or steps,

the edges should have contrasting color bands to aid people with lower/ impaired vision.

11. Wherever glass railings are provided they should have top handrails to support people with ambulant, non-ambulant disabilities and the elderly.
12. All controls and operating mechanisms shall be placed between 900 mm and 1200 mm and be located a minimum of 600 mm from any corner.
13. Providing automatic light controls (controlled with a remote control or app on a smartphone) or motion sensor lights makes it easier for elderly and people with reduced mobility to operate lights.
14. Provision of automated home safety and security helps people feel secure in their homes. It also allows people to communicate easily in case of medical emergencies.

### 6.1.8 Neighbourhood Play Spaces and Community Facilities

1. Any form of housing community or neighbourhood facilities need to ensure inclusive play and recreational spaces integrating children, elderly and social groups.
2. Play spaces shall be customized with play furniture, sensory landscapes and access routes to facilitate walking activities, social inclusion and community participation.
3. Community facilities like clubs, etc. shall also be guided by universal design approach to ensure access through entrance, accessible washrooms and circulation spaces.

Any residential society may have persons with disabilities, individuals with high support needs or shall have people going through life stages such as ageing,





Image 6.3 Accessible outdoor play space with safety child seating  
Photo Credits: Megha Vijay



Image 6.4 Accessible outdoor play equipment with safe surface material  
Photo Credits: Megha Vijay





Image 6.6 Accessible indoor play arena  
Photo Credits: Shreya Shetty



Image 6.5 Accessible play room interiors  
Photo Credits: Megha Vijay



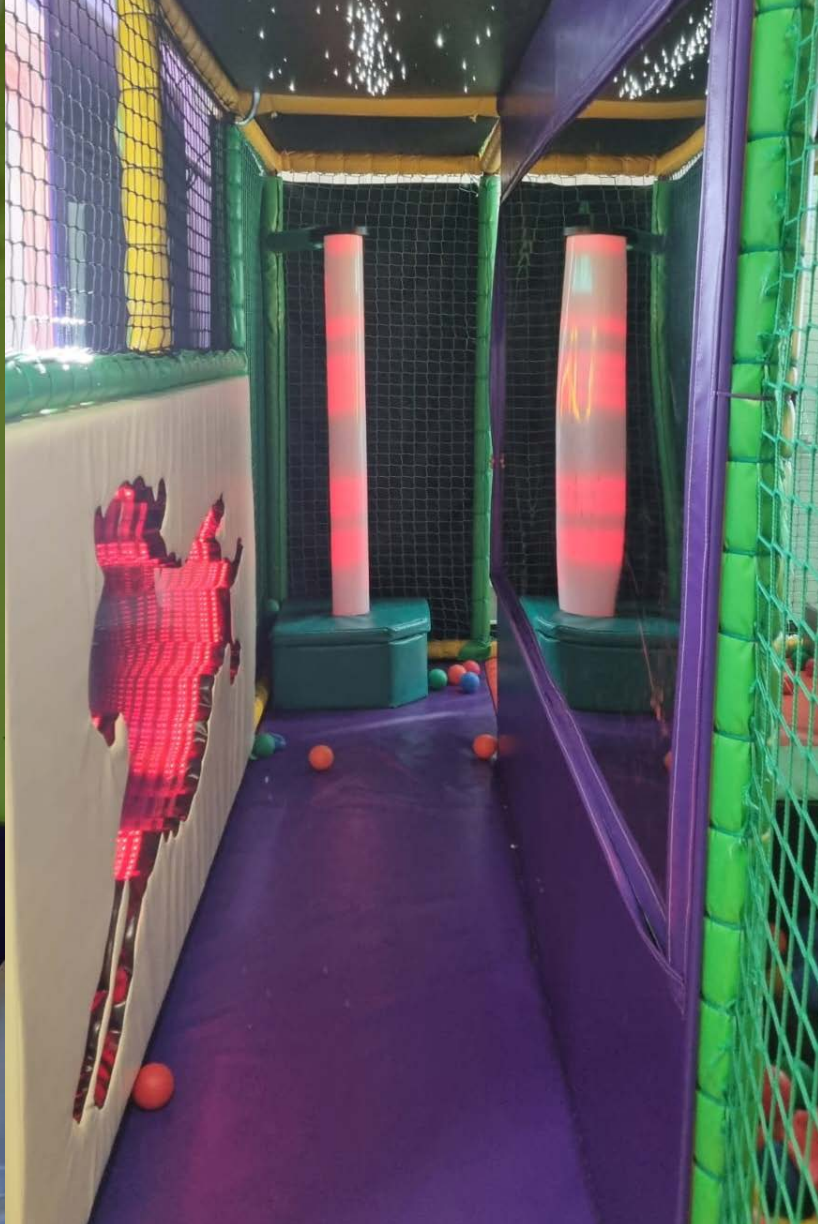


Image 6.7 Accessible indoor sensory play areas  
 Photo Credits: Megha Vijay

motherhood, neurodiverse situations, etc. at any given time, which could impact their functional abilities in the short or long run. It is therefore recommended to ensure a sensitive approach while planning and design of residential neighborhoods keeping in view diverse stakeholders.

## 6.2 Education and Research Buildings

All educational institutions shall make universally accessible provisions in their infrastructure and services to render a holistic approach to education. This includes to ensure universal accessibility

as an approach in master planning, site planning and built infrastructure detailing both at exterior and interior levels. Specific aspects for accessibility include mobility access to schools or institutions, entrances, circulation spaces (horizontal and vertical), learning spaces like classrooms, lecture theatres, laboratories, multi activity spaces like sports arenas, assembly areas and all others as deemed desirable for access to education in an inclusive manner.

Educational environments and typologies include a wide array of knowledge imparting and sharing institutions at all levels like schools (ranging from Primary, Secondary to High Schools), special

schools, coaching institutions, higher educational Institutions like colleges, skill development institutions, universities, research organisations and institutions, public institutions of specialised training like defence academies and other multiple sectors.

Access to education depends on various aspect ranging from information accessibility, movement to the physical infrastructure and support systems which facilitates accessible learning at various levels and various contexts. It is expected that mobility infrastructures shall provide universal accessible features to ensure ease in access right to education for all. Accessibility standards for support systems shall ensure that children with disabilities and diverse functional abilities can reach the educational infrastructure. Accessibility in the educational environment shall follow an integrated approach as specified in these guidelines.

Institutions should integrate the built and unbuilt spaces, ensuring the presence of accessible features. Mostly, open spaces are left inaccessible. Built and unbuilt spaces in institutions should strive to integrate universal accessibility into their character. This implies wider access routes, levels to be made accessible with ramps, provision of shaded seating spaces.

The following key recommendations are made towards realizing a universally accessible education environment and infrastructure.

### **6.2.1 Master Planning and Site Planning**

1. Universal accessibility must be ensured through master planning, zoning and site planning of educational campuses with a human centric approach. This includes planning for a walkable environment, ensuring seamless access for

wheelchairs, baby strollers and other wheeling situations through level crossings, kerb ramps, etc.

2. Use of sensory landscapes, tactile guiding routes in walkways, multi format signage and other features connecting one zone to another is highly recommended to retain an inclusive character of an educational environment.
3. The planning of academic, administrative or multi functional buildings must adhere to accessibility standards, in particular, the external and internal elements specified in Chapters 3, 4 and 5.

### **6.2.2 Mobility and Circulation**

1. Walkability and seamless mobility across the educational spaces shall be ensured through site planning and in building blocks through horizontal and vertical circulation system designs.
2. Level crossings, well designed kerbs, guiding systems along with support hand rails, tactile guiding systems and street furniture like resting spaces shall form an integral part of external mobility networks in educational campuses of all scales.
3. Sensory landscapes shall be wisely used to provide sensory cues to enhance mobility experience for all, especially for persons with visual impairments.
4. Mobility infrastructures need to be complemented by a culture of adopting accessible vehicles such as adaptive motorised and non-motorised vehicles.
5. Walking routes shall be at least 1200 mm wide with non slip flooring material and good ambient lighting to maximise contrast between level



Image 6.8 Accessible classroom facility  
Photo Credits: Dr. Gaurav Raheja

surfaces.

6. Persons with disabilities, with neurodiverse conditions, the elderly and many others should be able to independently move from one point to the other.

### 6.2.3 Formal and Informal Learning Spaces

1. Learning spaces comprise of enclosed spaces like classrooms, lecture theatres, tutorial rooms, etc. along with semi enclosed ones with landscapes, etc. for independent or collective group learning activities and informal interactions, etc.
2. Universally accessible learning spaces shall require the presence of accessible entrances and doorways, adaptive seating systems accommodating diverse student needs including those using wheelchairs, height adjustable black / white boards, projection systems and accessible learning technologies and support services.
3. Stepped lecture halls are recommended to have ramped aisles with a minimum width of 900 mm to making them accessible to persons with non ambulant disabilities. Actual aisle widths shall however be determined based on the capacity and size of the lecture theatre.
4. Learning spaces shall be guided by universal design features including the principle of flexibility in planning and use to accommodate future technologies in the same space. Transforming some of the existing learning infrastructure into Hybrid Learning spaces shall make them further inclusive.
5. Acoustic treatment and design of classrooms is highly recommended





**Image 6.9** Accessible computer laboratory  
*Photo Credits: Dr. Gaurav Raheja*

to include learners with hearing impairments as part of academic activities. Sign language interpretation alongwith close captioning or subtitles through technological interface shall be further required to address the learning accessibility needs for persons with hearing impairments.

6. Informal learning spaces like courtyards, corridor edges, landscape spaces etc. require accessibility features like step free spaces, seating with supports and knee clearances, free from physical, sensorial or any other form of barriers, if any.
7. It needs to be ensured that classrooms or informal learning environments be seamlessly accessible at all levels. It is therefore recommended to have well designed ramps as part of circulation spaces as well as interactive zones empowering an inclusive mobility

culture on educational campuses.

#### **6.2.4 Laboratory Spaces**

Laboratories are the prime spaces for engaging practical learning in controlled environments along with knowledge development through research. Accessibility features in laboratories can make the entire educational experience inclusive while inaccessible laboratories may lead to a form of exclusion.

1. Universally accessible laboratories imply access to reach the laboratory, wider doorways to facilitate movement for all, internal layout facilitating wheelchair maneuvering spaces including adaptive and flexible furniture for safe usage and ergonomic convenience.
2. Legibility in laboratory environments

with clear surface distinction and colour systems shall be desirable to ensure visual accessibility especially for persons with low vision and preventing any misinformation leading to any vulnerable situation or accident.

3. Emergency or safety signs shall be visible in high contrast and tactile guiding systems for accessible circulation and safety
4. Laboratories with wet systems involving water, chemicals or fluids require safety protocols to ensure complete avoidance of accidents and prevention of slips or falls with due to wet floors.
5. Laboratory spaces with technical equipments need to ensure access around the machines and anthropometric adaptability to functionally use the equipment for the same.

#### **6.2.5 Library and Reading Spaces**

1. The aisle width should be minimum 900 mm wide to allow a wheelchair user to access the bookshelves.
2. It is preferable to have the height of shelves restricted to 1200mm which allows everyone to have easy access to the books.
3. Exclusive reading rooms with enhanced audio features or cubicles with audio book integration shall be provided.
4. E-books in audio format shall be made available in the library.
5. RFID tagging system is recommended for ease of identification and location of books.
6. There shall be provision of digital catalogue which provides information on all books that can be easily accessed in the library.

7. The reading spaces should have flexible furniture layout which allows ambulant or non ambulant users with diverse assistive technologies to choose a place as per their convenience.
8. It is preferable to have chairs with adjustable heights which will cater to a wide range of user groups.
9. Libraries are recommended to make use of integrated online services and repositories of accessible literature in diverse fields of education.
10. Facilities like braille printing may be sourced for readers with special needs of tactile format of reading.

#### **6.2.6 Multi Activity and Recreational Spaces**

1. All administrative and common areas like waiting rooms, lift lobby etc. should be accessible to persons with disabilities.
2. Arrangements for wheelchair users by means of ramps/ lift should be made for stepped lecture halls or auditoriums.
3. At least one accessible unisex washroom should be provided on each floor including student dormitories and residential accommodations.
4. Provision of child friendly sanitation fixtures and accessories in washrooms.
5. All recreational facilities like playgrounds, gymnasiums and sports complex, landscape areas etc. should be accessible and usable by Persons with Disabilities.
6. Institutions for physical education, police or military training and other activities requiring full physical abilities should also be made accessible for administrative staff members, employees, and visitors



Image 6.10 Accessible playground with variety of play options  
 Photo Credits: Megha Vijay

with disabilities.

7. Provision of Public Address (PA) system in case of emergencies like fire /natural disaster etc. to assist evacuation and be supported through uninterrupted power supply

### 6.2.7 Playgrounds and related areas

Playgrounds that offer a variety of different types of play options (visual, auditory and tactile) should be provided. A playground is considered accessible when it fulfils the following conditions:

1. It meets the basic requirements relating to accessibility of fixed accessible urban furniture.
2. Playground surfaces shall consist of rubber or compacted sand.
3. Surface of the children play area shall be smooth & firm and free from any sharp objects, projections etc., in order to avoid injury to the children.
4. All children, regardless their functional limitations, and according to the age group for which the playground is intended, shall enjoy and use, at least,

50% of individual and group related activities.

5. All materials exposed to sun radiation shall not reach temperatures that may hurt the users.
6. Materials used to design children's games, especially the sliding ones, shall not contain plastics or metals that produce electrostatic discharges that may deprogram hearing aids.

### 6.2.8 Residential Spaces

Residential amenities in educational environments include student hostel or housing, faculty or staff housing along with guest houses for visiting guests. It is recommended to make universal accessibility provisions for the same.

### 6.2.9 Emergency Support Systems

Educational environments need to provide due care and access to emergency support systems also ensuring rehabilitation support to persons with disabilities during their stay in that environment.



### 6.3 Transportation and Supporting Infrastructure Services

Mobility is critical for all systems of built infrastructure and to support access to major activities of daily living for diverse population groups. Universally accessible transportation and its infrastructure play a key role towards urban inclusivity by supporting accessible mobility.

The transportation systems enable individuals with the ability to move within community environments that expand from one’s home, to the neighborhood, and to regions beyond. Mobility is a fundamental requirement

for all individuals which connect them with learning environments, business facilities and social aspects of life. All these are important to lead a life of respect and dignity and to promote the well-being of everyone. Various modes of transportation like surface transportation, railways, airports, waterways, etc. require specific guidelines and standards to ensure accessibility and an integrated multi modal transit systems. It is therefore recommended to develop specific guidelines for each of these sections.

The system mainly comprises of surface, rail, air, and water transports. The

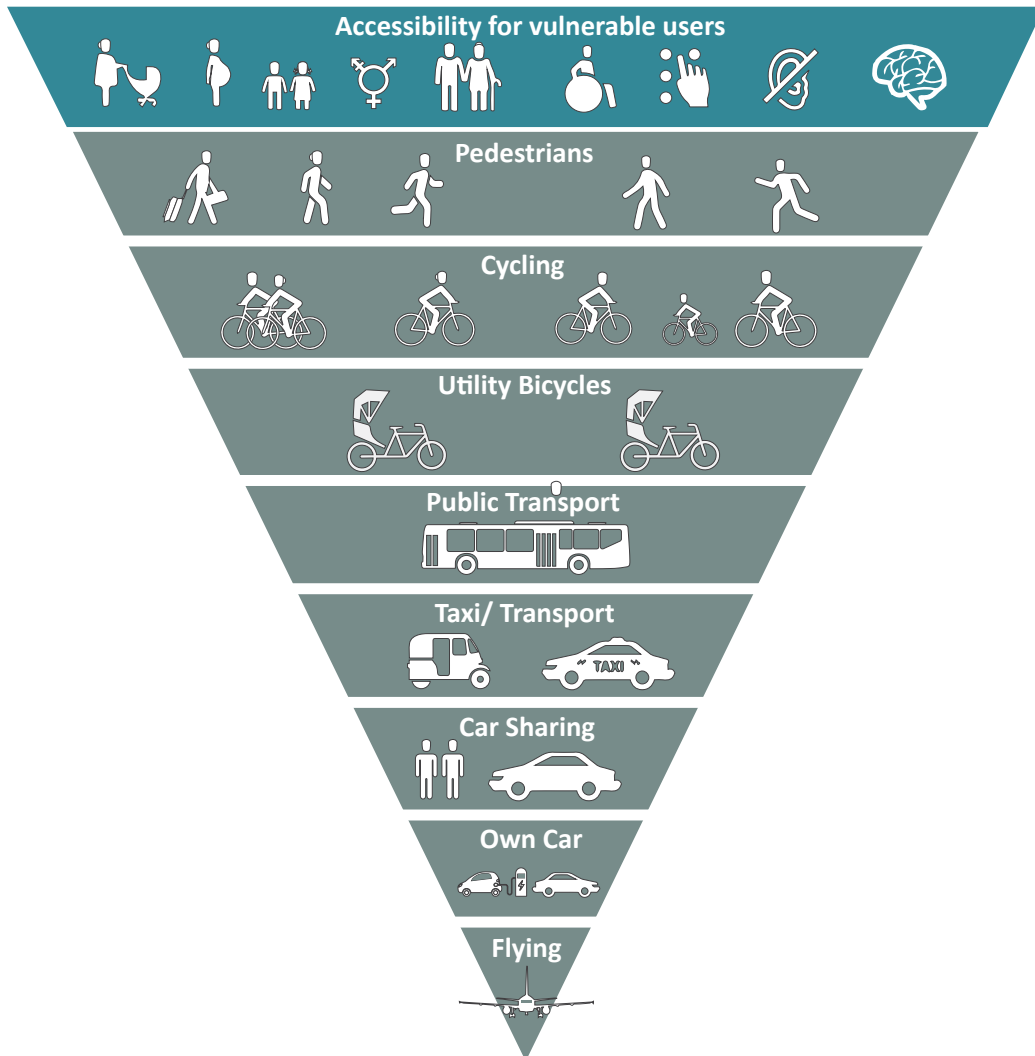


Figure 6.1 Adapted Mobility Pyramid

existing transportation model consists of pedestrian infrastructure like streets, traffic refuge areas and crossings traffic signals, Foot over Bridges, underpasses, Non-Motorized Vehicles like Rickshaws (NMT), Mass rapid transit system (MRTS) like Metro, Bus Rapid Transport System (BRTS), taxi services and personal/shared bicycles etc.

To provide a seamless mobility experience to all (including persons with disabilities, elderly, children and gender friendly), the

built infrastructure should be planned and designed to remove physical and environmental barriers. The following design recommendations should be followed to enhance the mobility experience for all user groups.

### 6.3.1 Land / Surface Transport

#### 6.3.1.1 General

1. Buses, trams, taxis, mini-buses, and

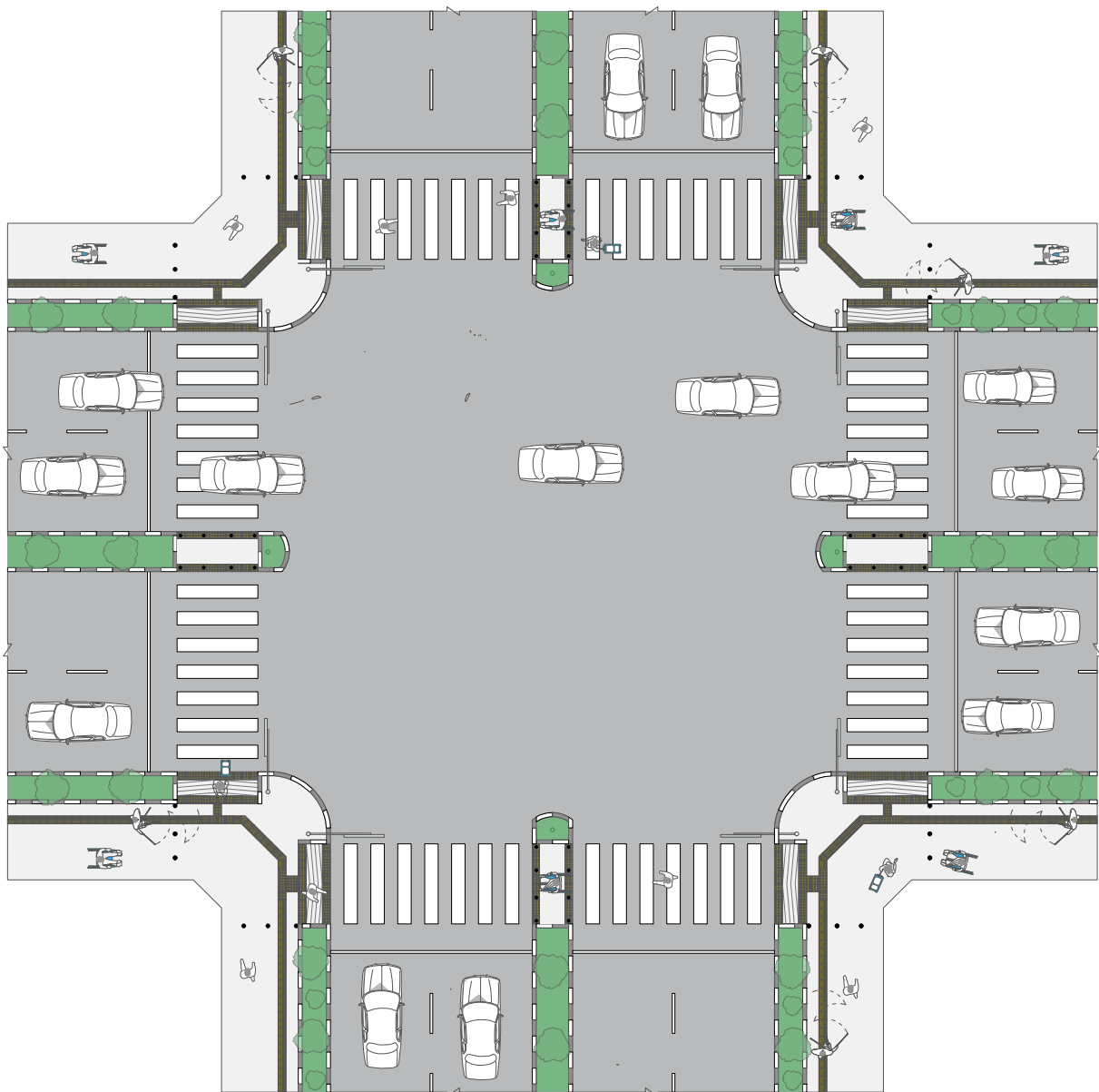


Figure 6.2 Road Intersection with accessible features

three-wheelers should be designed as far as practicable to include facilities that can accommodate people with disabilities.

2. New vehicles when purchased should comply with accessibility standards to enable all people, including those in wheelchairs, to use the service provided.
3. All travel routes to bus stops should also be barrier-free to ensure that persons can travel from their homes to their chosen pick-up point.
4. Training should be provided for drivers to help them become aware of the needs of Persons with Disabilities.

### 6.3.2 Bus Stops / Shelters

Bus stops are the boarding places for

passengers for buses. Following are the design recommendations :

#### 6.3.2.1 Bus Stop Design

1. At least one accessible route should be provided from the alighting and boarding point of the bus stand to the walkway that leads to the accessible building entrance.
2. Directional signs should be installed to direct Persons with Disabilities to an accessible entrance.
3. TGSIs blocks should be provided along the accessible walkway from the bus stand to the building entrance to aid persons with visual impairments.
4. The bus stand shall have minimum illumination level of 50 lux.



Image 6.11 Accessible approach for bus shelter  
Photo Credits: CPWD





Image 6.12 Accessible bus station: Ahmedabad BRTS  
Source <https://www.thecityfix.com/blog/more-on-ahmedabad-janmarg-brt-accessibility-and-signage/>

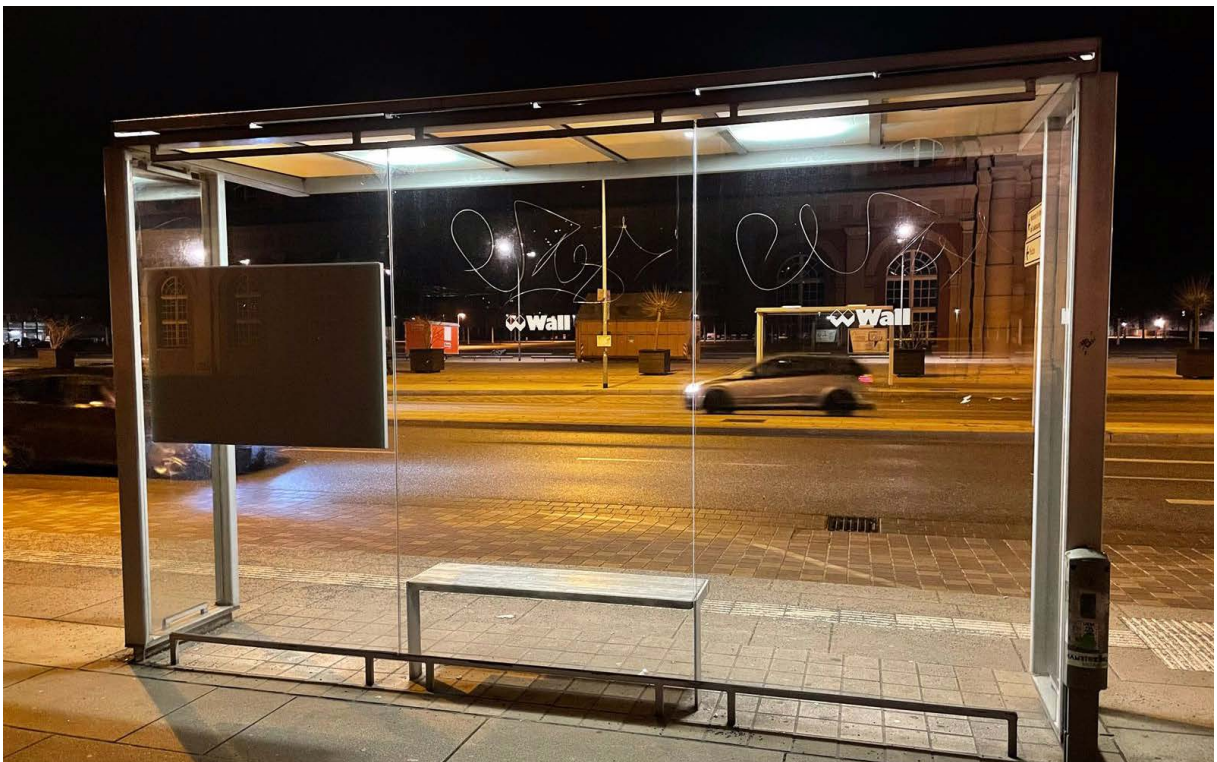


Image 6.13 Accessible bus shelter  
Photo Credits: Dr. Gaurav Raheja





Image 6.14 Accessible bus station with level approach  
Photo Credits: CPWD

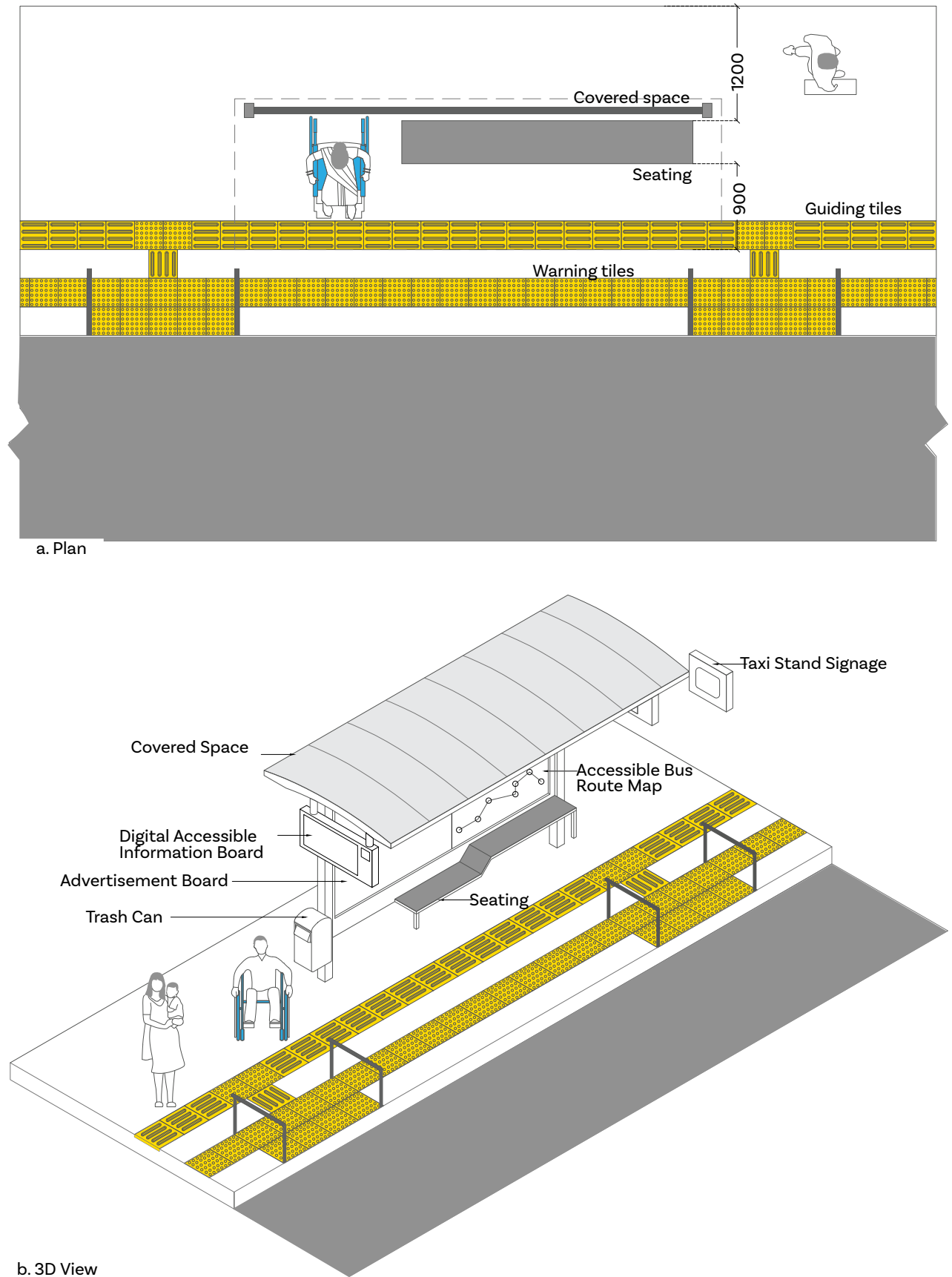


Figure 6.3 Bus shelter details





Image 6.15 Accessible bus interiors

Photo Credits: Dr. Gaurav Raheja

5. Bus stand should be located nearest to an accessible entrance.
6. Where transfer must be made from a vehicular surface to a pedestrian surface, the driveway, pathway, or walkway should be blended to a common level or be ramped.
7. A clear passageway with a minimum width of 1200mm should be provided.
8. Seats should be provided at the bus stand for people with ambulatory disabilities. These seats should be positioned such as not to impede the movement of wheelchair users.
9. A shelter should be provided at the bus stand for protection against adverse weather conditions.
10. If a bus stand is not at the same level as the walkway or pathway, it should have two separate ramps for boarding

and alighting.

11. Where there are curbs between the access aisle and the vehicle pick-up space, it should have a kerb ramp. The minimum lighting should not be less than 80-100 Lux.

#### 6.3.1.2 Accessible buses

Accessible buses should have the following features:

1. Bus doors should be at least 1200 mm wide.
2. Should be low floor.
3. Have handrail and footlight installed.
4. Have apparatus such as a hydraulic lift or pull-out/foldable ramp installed in the doorway for mobility aided users/ prams.





Image 6.16 Accessible buses with level approach: Ahmedabad BRTS  
Photo Credits: CPWD



Image 6.17 Accessible buses with folding ramp  
Photo Credits: Dr. Gaurav Raheja



5. Space for a wheelchair should be provided in an appropriate position, without preventing other passengers from getting on and off.
6. The location of that space should be as indicated, inside and outside the bus, using the standard symbol for wheelchair accessibility
7. Wheel stoppers and wheelchair safety belts should be provided
8. An appropriate number of alighting buzzers should be provided in positions that are easily accessible for seated or standing passengers
9. The push button of an alighting buzzer should be clearly visible of, adequate size, installed at 900 mm to 1200 mm from the bus floor level and display the information in Braille/

raised numbers as well.

10. Information on the names of all stops along a bus route should be indicated inside the bus by displaying the text in a suitable position.
11. Information on a route and its final destination should be displayed outside the bus in large text, especially on the front and side of the bus. This information should be in a bright contrasting colour and be well illuminated with an external light to make it readable in the dark.

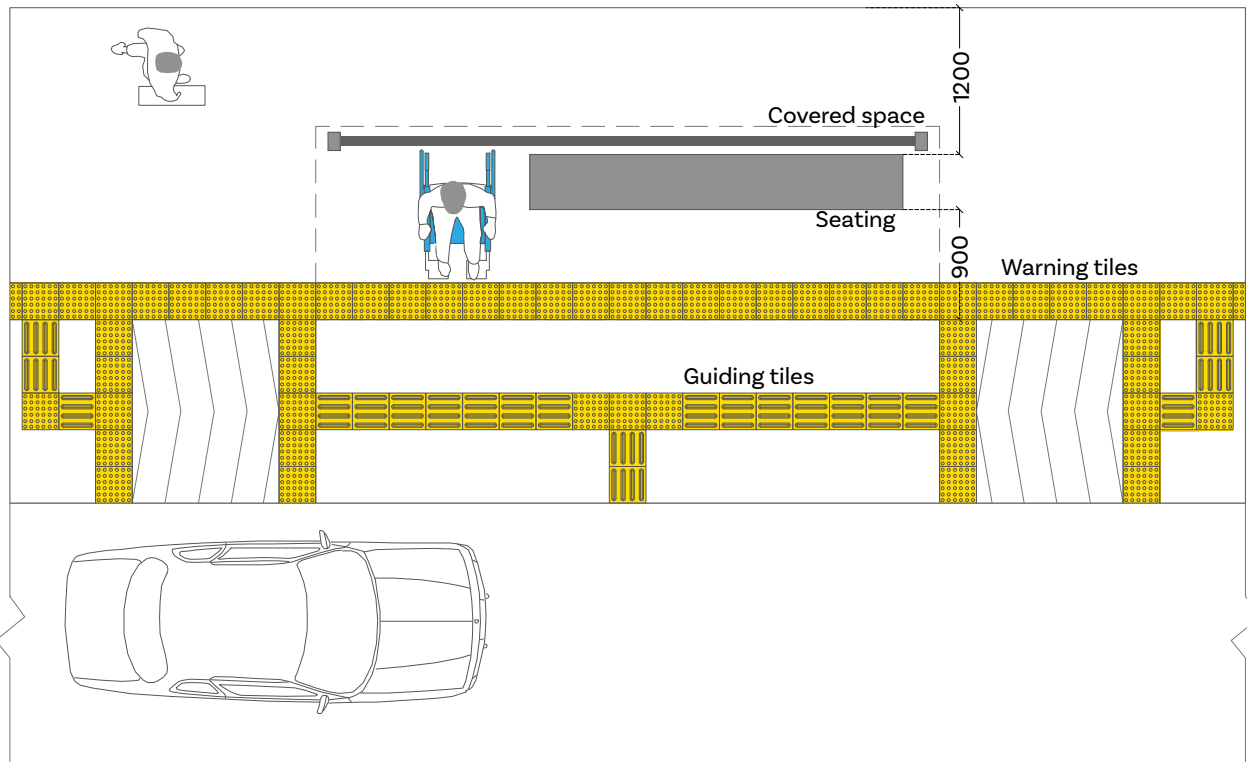
### 6.3.1.3 Taxi

Taxi should be adapted to allow passengers to get in and out of them while remaining seated in their wheelchairs.

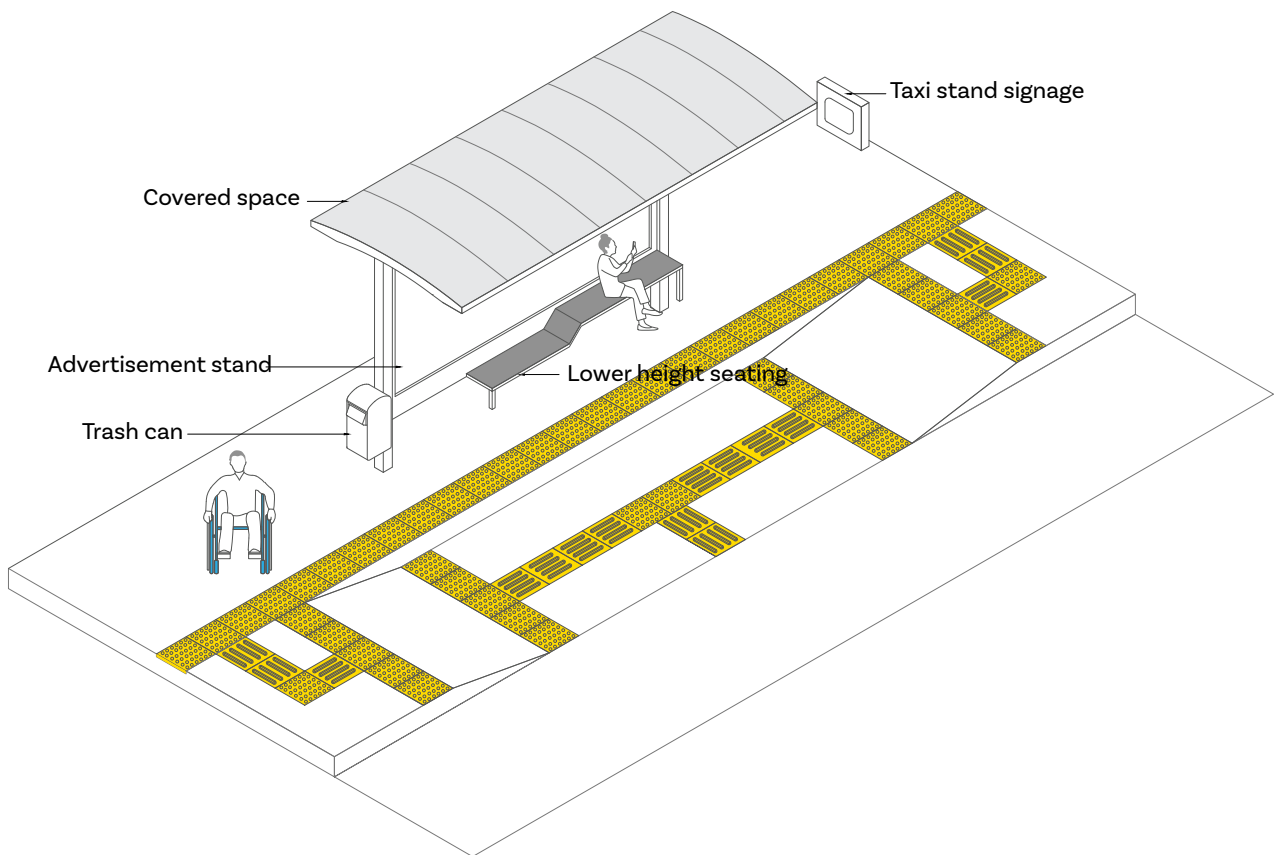


Image 6.18 Accessible Taxi: pick up and drop off  
Photo Credits: Dr. Gaurav Raheja





a. Plan



b. 3D View

Figure 6.4 Taxi drop off stand

### 6.3.1.4 Rail Transport

Whether over-ground or underground, rail travel is a highly effective mode of transport.

#### 6.3.1.4.1 Level Approach

1. Approach route should not have level differences. If the station is not on the same level as the walkway or pathway, it should have a ramp.
2. Walkway surfaces should be non-slip.
3. Approach walkway should have TGSIs for persons with visual impairments.

#### 6.3.1.4.2 Station Entrances and Exits

These should have a minimum width of 1800mm and must be leveled or ramped.

#### 6.3.1.4.3 General Station Interiors

1. There should be a tactile layout map of the station with Braille and audio labels placed at the entrance. Tactile map should be marked by floor tactile guidance for persons with visual impairments to access it.
2. The lobby/corridor width should be at least 1800 mm.
3. The floor surfaces should be non-slip and level.



Image 6.19 Accessible metro rail  
Photo Credits: Dr. Gaurav Raheja

4. There should be directional signs indicating all the facilities and the various platform numbers.
5. The signage should also be displayed in Braille/raised numbers to aid people with visual impairments.
6. Guiding and warning blocks should be installed on the corridors/concourse.
7. Wherever there is a provision of stairs and ramps, they should comply with Chapters 3 and 4.
8. All the audio announcements should be supplemented with visual information displays for people with hearing impairments.
9. Seating areas should be provided at regular intervals for people with ambulatory disabilities.
10. For persons with hearing impairments, an electronic signboard (digital display) should be displayed on each platform at conspicuous location for all announcements made by the railways.
11. The washrooms should be universally designed and comply with the design requirements listed in Section 4.9.2
12. Staff should be trained in methods of assistance and be at hand on request.
13. Stations for all rail travel should be fully accessible with extra wide turnstile/automatic fare collection (AFC) system where possible alongside wheelchair accessible doorways.
14. Staff should be on hand to assist Persons with Disabilities to enter or exit through convenient gates.
15. All new railway stations should be designed to be fully accessible, while those being retrofitted should comply with standards given in these Guidelines.

#### **6.3.1.4.4 Reservation and Information Counters**

1. Should have clear floor space of at least 900 mm x 1200 mm in front of the counters.
2. There should be at least one low counter at a height of 750 mm to 800 mm from the floor with clear knee space of 750 mm high by 900 mm wide and 480 mm deep.
3. At least one of the counters should have an induction loop unit to aid people with hearing impairments.
4. The counters should have pictographic maps indicating all the services offered at the counter and at least one of the counter staff should be sign language literate.

#### **6.3.1.4.5 Platforms**

Platforms should:

1. Have a row of warning blocks installed 600mm before the track edge.
2. Have non-slip and level flooring.
3. Have seating areas for people with ambulatory disabilities.
4. Be well illuminated, lux level 35 to 40.
5. There should be no gap or difference in level between the train entry door and the platform.
6. All platforms should inter-connect by means of accessible routes or lifts.
7. Provide accessible level entrance to the train coach.

#### **6.3.1.4.6 Railway Carriage**

Railway cars should have the following features:





Image 6.20 Levelled approach on accessible train platform  
Photo Credits: DMRC



Image 6.21 Inclusive vertical circulation in train station enabled with Lift, staircase and escalator  
Photo Credits: DMRC

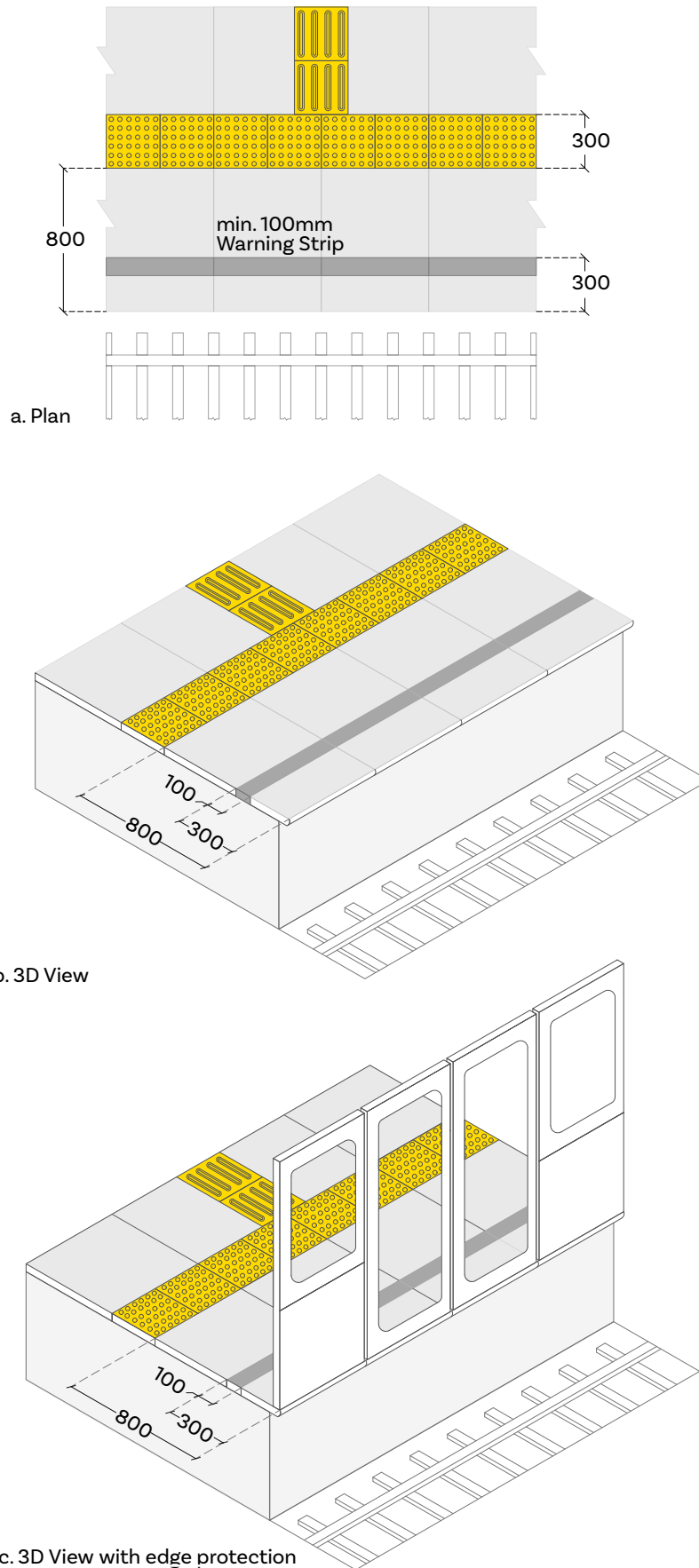


Figure 6.5 Configuration and layout of tactile guiding and warning tiles for metro





Image 6.22 Accessible metro rail coach design and seating  
Photo Credits: Dr. Gaurav Raheja

1. Railway car doors should be at least 900 mm wide. The gap between the car doors and the platform should be less than 12 mm.
2. Identification signage on the door for wheelchair accessible coach.
3. If the car door and the platform cannot be at the same level, then at least one car door should have apparatus such as a hydraulic lift or pull-out ramp installed in the doorway for wheelchair users.
4. Space for a wheelchair should be available at the side of the door.
5. The space should be indicated inside and outside the car by using the international symbol of accessibility.
6. Wheel stoppers and ring-strap or other appropriate safety grip should be provided for wheelchair users.
7. An appropriate number of designated seats for passengers with disabilities and elderly people should be provided near the doors.
8. Aisles should be at least 900 mm wide.
9. A map of train routes should be installed. This should be in Braille/raised numbers as well.
10. In each car, there should be an announcement and provision of a visual display of the names of stations route. This display should be in raised numbers with sharp contrast from the background.





Image 6.23 Accessible metro station entrances: Kochi Metro Station  
Source [https://en.wikipedia.org/wiki/Ambattukavu\\_metro\\_station](https://en.wikipedia.org/wiki/Ambattukavu_metro_station)



Image 6.24 Color contrast and Leveled platform, Koch Metro Rail  
Source: [https://commons.wikimedia.org/wiki/File:Kochi\\_Metro\\_Rail.jpg](https://commons.wikimedia.org/wiki/File:Kochi_Metro_Rail.jpg)





Image 6.25 Color contrast and TGSi layout: Koch Metro Rail  
Source: [https://en.wikipedia.org/wiki/Kolkata\\_Metro#/media/File:Kolkata\\_Metro\\_CRRC\\_Dalian\\_rake\\_3.jpg](https://en.wikipedia.org/wiki/Kolkata_Metro#/media/File:Kolkata_Metro_CRRC_Dalian_rake_3.jpg)



Image 6.26 Color contrast and Illumination on Metro Platform  
Source: [https://commons.wikimedia.org/wiki/File:Train\\_at\\_Aluva\\_Metro\\_Station.jpg](https://commons.wikimedia.org/wiki/File:Train_at_Aluva_Metro_Station.jpg)





Image 6.27 Reserved accessible seating inside metro rail coach  
Photo Credits: Dr. Gaurav Raheja





Image 6.28 Accessible automatic fare collection (AFC) system in Metro Stations  
Photo Credits: Dr. Gaurav Raheja

### 6.3.2 Water Transport

Water transport consists of passenger boats, ferries, ships, and cruise ships. Following are the design recommendations.

#### 6.3.2.1 Piers and Jetties

All forms of water transport should be accessible to people with disabilities.

1. Ferries should be fitted with accessible ramps.
2. Within a cabin, space should be set aside for securing a wheelchair in a position for comfortable integration with other passengers.
3. Piers should be fully accessible and have simple boarding and

disembarkation procedures.

4. Guidelines for designing accessible piers and jetties are like the ones for railway stations except for the platform.

#### 6.3.2.2 Water Transport Crafts

1. Doors should be at least 900 mm wide.
2. Aisles should be at least 800 mm wide.
3. An accessible toilet and shower cubicle should be provided on board the ship, complying with Section 4.9.
4. Wheel stoppers and ring-strap or other appropriate safety grip should be provided for wheelchair users.



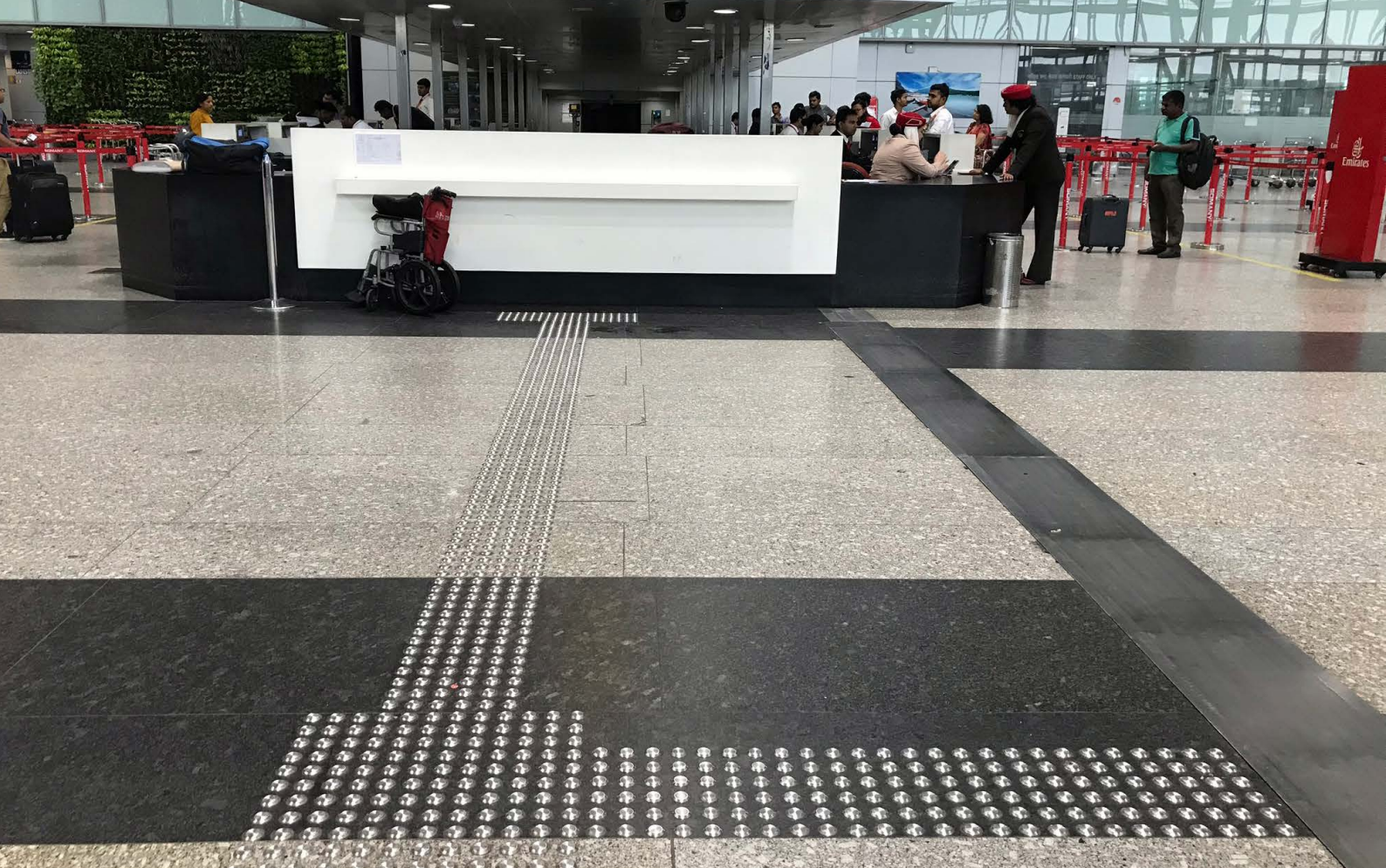


Image 6.29 Accessible airport facilities: Tactile ground surface indicator used inside airport  
 Photo Credits: Dr. Gaurav Raheja

### 6.3.3 Air Transport

Air transport needs to integrate accessibility from the point of departure to the point of arrival at the destination. Such compliance shall require detailed guidelines from the respective ministry of civil aviation with specific features of accessible air transportation. Besides the common principles and elements as already stated in these guidelines, the core purpose is to enable and facilitate travel for passengers with diverse mobility needs and functional limitations both in airport infrastructure as well in the aircraft. Some of the key recommendations shall include:

#### 6.3.3.1 Airport Infrastructure

1. Provision of self-check in counters to reduce the waiting time in check in counters.
2. Use of good wayfinding system from

the entrance till the departure gates.

3. There should be provision of tactile map and braille map for persons with vision impairments.
4. The management should have provision to load wheelchairs and rollators at the airport for different user groups.
5. Provision of golf buggies to move around the airport for Persons with Reduced Mobility and Persons with disabilities to reach the correct gates conveniently.
6. Personal assistance to Persons with disabilities to help them through their journey within the airport and to help them reach their designated seat within the aircraft.
7. Personal assistants shall be trained to help Persons with disabilities and Persons with Reduced Mobility (PRM) navigate safely and comfortably





Image 6.30 Accessible ramps for aircraft boarding

Photo Credits: Shreya Shetty





Image 6.31 Golf carts at the airport  
Photo Credits: Dr. Gaurav Raheja

within the airport facility.

8. Provision of elevators, escalators, travellers to ease horizontal and vertical circulation around the airport.
9. The flooring surfaces should be non-slip and smooth for easy maneuverability of wheelchairs, luggage trolleys and carts.
10. The washrooms shall be universally designed and comply with the design standards mentioned in Section 4.9.
11. There shall be family friendly facilities like – Family washrooms, Lactation rooms for nursing mothers, diaper changing facility and child protection seats in both male and female washrooms. (Refer Section 4.9 for details)
12. Illumination should be uniform and glare free. The interior surfaces shall be of matt finish and not glossy and shiny.

### 6.3.3.2 Accessible Aircraft

1. All airports should be fully accessible and have appropriate boarding facilities.
2. Special attention should be given to accessible toilet facilities on board aircraft.
3. Doors should be at least 900 mm wide.
4. Aisles should be at least 750 mm wide
5. An accessible toilet cubicle should be provided on board the aircraft.
6. Plugs should be accessible for passengers requiring their respirators to be plugged into electricity outlets.
7. Appropriate assistive technologies should be integrated for transfer of passengers with diverse disabilities or with high support needs.





Image 6.32 Accessible baggage belt at the airport  
Photo Credits: Dr. Gaurav Raheja

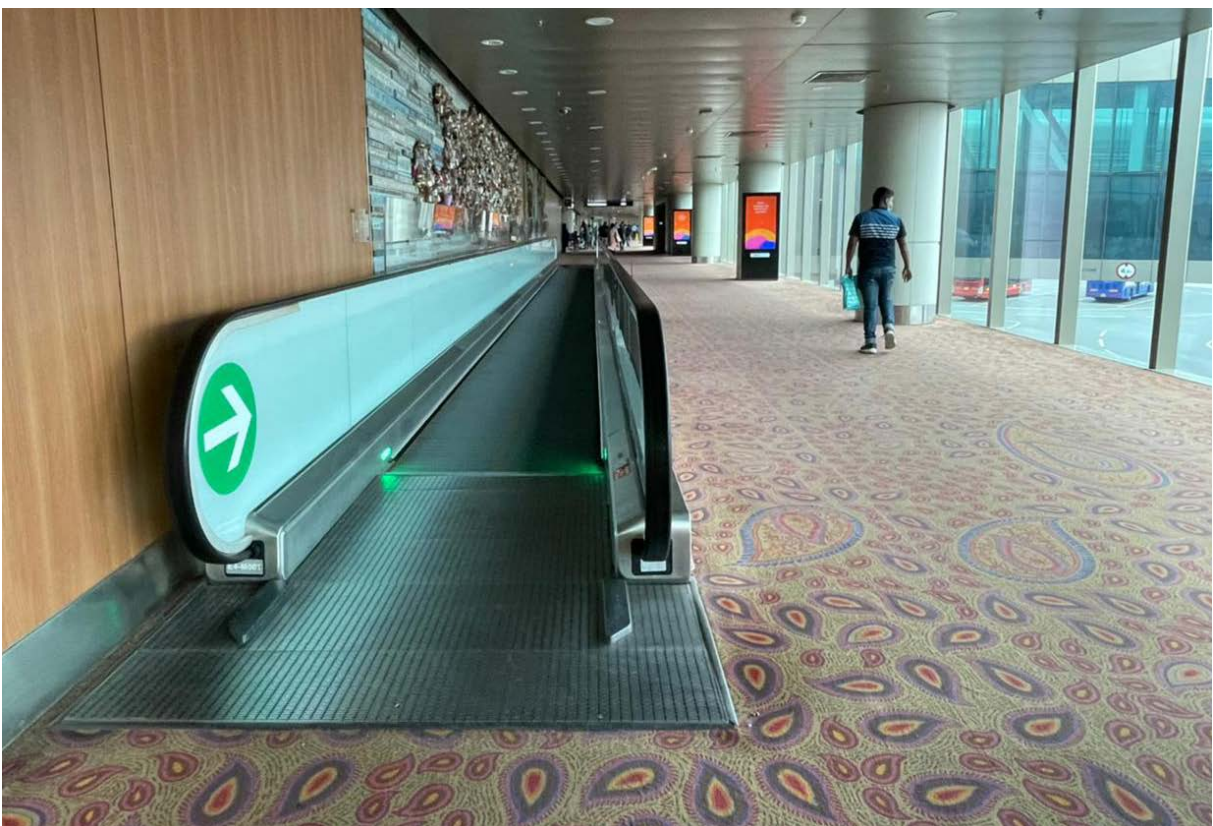


Image 6.33 Accessible Travellator at the airport  
Photo Credits: Dr. Gaurav Raheja





Image 6.34 Accessible aerobridge for boarding the passenger  
Photo Credits: Dr. Gaurav Raheja







Image 6.35 Accessible entrance for office building  
Photo Credits: Dr. Gaurav Raheja

#### 6.4 Office and Public Buildings

Office spaces typically include workspaces with both public and private managements usually referred as Public Sector or Government Offices and Corporate Offices. Accessible offices or work spaces imply a provision of equal opportunity to persons with diverse needs or backgrounds. A diverse human environment typically constitutes an inclusive workspace culture which needs to meet adequate accessibility provisions for the same. Some of the key recommendations include:

1. Accessibility in workspaces implies integration and inclusion of human diversity with diverse abilities, gender and persons with disabilities such that there is seamless empowerment through infrastructure and its allied facilities.
2. All office spaces should be designed to be universally accessible for all individuals. This enables everyone the

right to work and earn a livelihood for themselves.

3. It is recommended that all workspaces shall enlist and inform through their respective websites about the level and extent of accessible features provided in their work space environments.
4. The entrances should be clearly identifiable and accessible to everyone.
5. In case of multi storied buildings, each floor should be made accessible by the provision of lifts.
6. The access routes should be clear of any obstructions and hindrances.
7. The internal circulation in the office spaces can be made identifiable by use of flooring of contrasting colors.
8. The internal environment should be made comfortable for the employees and visitors by provision of good air quality with the aid of HVAC and adequate ventilation system.



9. The AHU and other noise-creating machine rooms, along with printing rooms and cafeterias should be placed away from the working zone to allow smooth workflow for the employees.
10. The illumination should be glare free and the users should have the control over local lighting near their workstations.
11. The individual working area or workstations should be adaptable to suit the needs of different user groups.
12. This may include the flexible arrangement of furniture and the provision of height-adjustable desks to support needs of people with diverse anthropometric or body requirements.
13. The heights of chairs should be adjustable and they should have removable armrests, as well as a neck or headrest.
14. Workspace zones shall be acoustically treated to ensure clear audibility and glare free spaces to free spaces for accessible communication and include persons with hearing impairments in work environments.
15. Amenities like drinking water, vending machines, washrooms should be centrally located and accessible to everyone.
16. Washroom designs must integrate universally accessible features including gender neutral facilities for

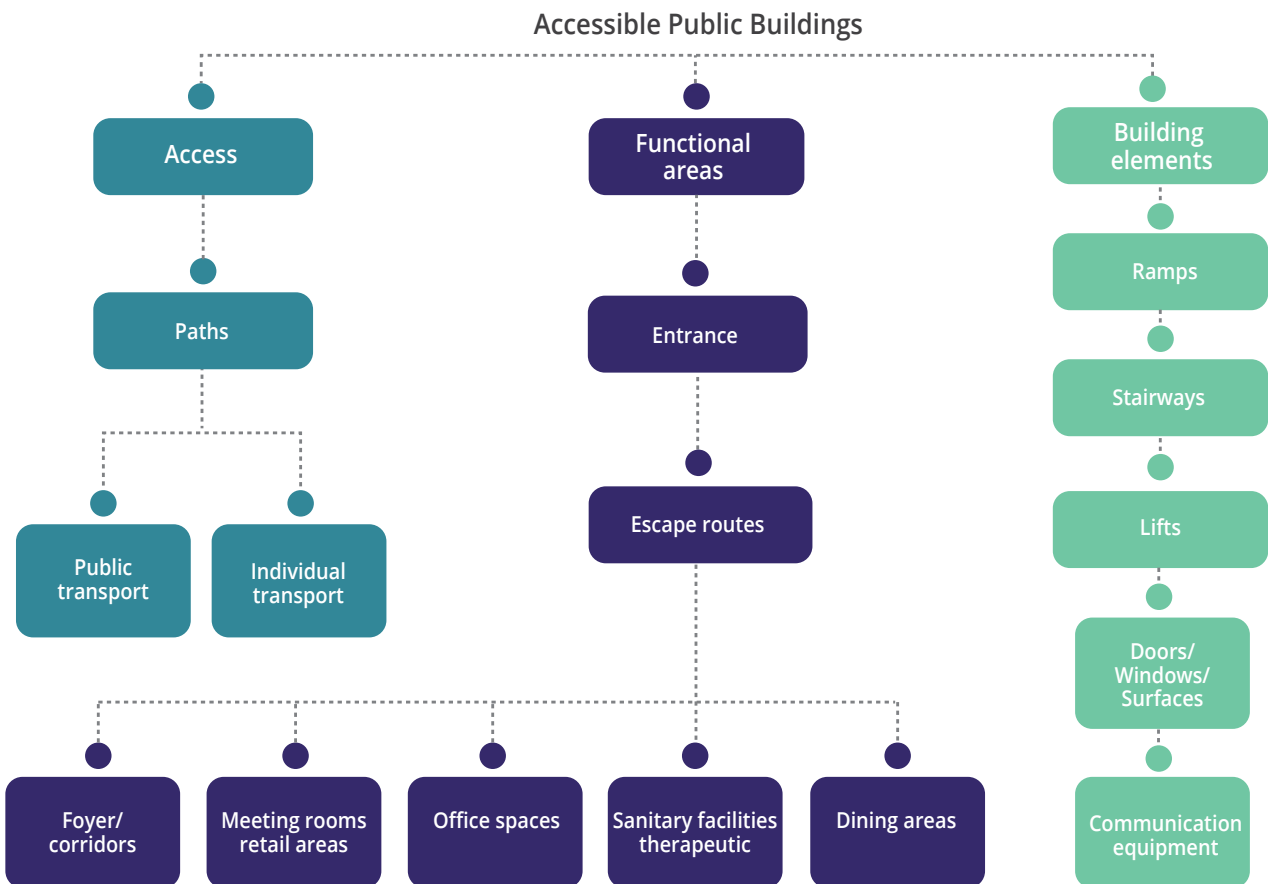


Figure 6.6 Accessible public building



sanitation and related care needs.  
(Refer Section 4.9 for details)

17. There shall be a provision of a Lactation or Baby Feeding Rooms in the building to be used by nursing mothers. (Refer Section 4.9.15 for details)
18. Wherever possible there should be a Creche in the office building which can be used by parents of younger children.
19. Personal shelving and common storage facility should be accessible and usable by everyone.
20. Emergency evacuation routes and protocols must be in place, reviewed and sensitized with priority to persons with disabilities and others with high support needs or functional limitations during emergency situations.
21. The egress map should be placed at strategic locations along with emergency signage leading the way to exit routes.
22. The provision of a Public Address (PA) system in case of emergencies like fire /natural disaster etc. shall assist in evacuations and shall be supported by uninterrupted power supply.
23. Accessible assembly areas should be clearly demarcated with clear signage in building outdoors.

## 6.5 Healthcare Buildings

The healthcare infrastructure caters to people from all user groups. Right from the birth of an individual to the final stages of a person's life, healthcare infrastructure is vital for a range of health functions ranging from monitoring, managing and treatments for all. Healthcare facilities ranging from primary to tertiary and super specialty levels of care require to

sensitively design built environments ensuring supportive features for the mobility of a wide range of stakeholders including patients with diverse health conditions, disabilities, age, gender, etc. along with the support staff. Other than the general requirements mentioned in Chapters 3, 4 and 5, the following recommendations should be followed to ensure access to all in healthcare infrastructures.

1. Healthcare systems shall provide a seamless experience to all, through a patient friendly environment using appropriate features making it a universally accessible experience for all.
2. Clear zoning of various healthcare facilities shall be well integrated through an accessible wayfinding signage system using universally accessible features like pictograms and icons alongwith multi lingual features in contrasting colour scheme alongwith braille.
3. Dedicated parking spaces for people with disabilities should be reserved near the entrance of the healthcare building.
4. Emergency entrance of hospitals shall be clearly distinguishable while other entrances shall be clearly identified as well with pictograms or entry signage etc.
5. Preferably step free entrance is recommended from the drop off or entry porch of hospitals to their internal spaces to ensure accessible movement of stretchers, wheelchairs and persons using other assistive devices for movement.
6. Mobility and circulation routes to various health care functions like Registration counters, OPD's, Diagnostics, etc. shall be planned in a way to optimize movement for all.
7. The horizontal and vertical circulation



Image 6.36 Accessible hospital beds, emergency call button and Golf carts at the hospital  
Photo Credits: Shreya Shetty

in healthcare infrastructure should be planned and designed for easy movement of stretchers and gurneys throughout the facility.

8. Vertical circulation shall be taken care through well designed accessible ramps, lifts and staircases as per the guidelines mentioned in Chapter 4.
9. Hospital zoning shall take care of locating various departments like orthopedics etc. and other related diagnostic facilities at an optimal distance from the entrances to ensure people with reduced or limited mobility to be able to access them with ease.
10. At the same time, it shall provide support features like grab rails in

contrasting colours, adequate waiting spaces and zones with quiet spaces for persons with diverse needs.

11. Universally accessible washrooms with wider doors as per the specifications mentioned in Section 4.9 shall be recommended for public washrooms in healthcare facilities.
12. The facility should have TGSi tiles laid out at the entrance up to all major departments and common areas for persons with impaired vision and blindness.
13. All the counter spaces at the reception, dispensary, accounts section etc. shall be designed to cater to wheelchair users.
14. Wherever there is a need for form





Image 6.37 Accessible internal ramp in the hospital  
Photo Credits: Dr. Gaurav Raheja





*FF*  
**Café Frisco**

Group of people sitting around a table in the courtyard, engaged in conversation. Some are wearing white uniforms, possibly medical staff.

People sitting on chairs in the courtyard, some looking towards the group in the center.

filling, seats and counters should be provided for users to place the forms and fill them conveniently.

15. The waiting hall should have reserved spaces to be used by wheelchair users.
16. The wayfinding design should be designed to provide guidance and clear directions for visitors to find their way within the building. Tactile and Braille signs should be provided to facilitate persons with visual impairments.
17. The egress map should be placed at strategic locations along with emergency signage leading the way to exit routes.
18. The corridors should have handrails along the route to aid users who require support while moving.
19. The illumination should be managed to avoid glare and provide uniform lighting in common spaces.
20. Common spaces like waiting halls, cafeteria, landscape gardens and amenities like drinking water, vending machines, washrooms should be easily located and accessible through signage and an unobstructed travel path.
21. There shall be provision of a Lactation Room in the building to be used by Nursing mothers. (Refer Section 4.9.15 for details)
22. The flooring of the areas that are accessed by the public shall be made up of non-slippery materials
23. Hearing enhancement systems such as the use of loop induction system or other advanced technologies should be integrated in hospitals and clinics.
24. Sign language support for OPD consultations and at reception counters is recommended to facilitate access to persons with hearing impairments.

25. The Provision of Public Address (PA) system in case of emergencies like fire /natural disaster etc. shall assist in evacuations and shall be supported by uninterrupted power supply.

26. Accessible evacuation routes and emergency protocols and services shall be periodically reviewed to ensure safety against such disasters.

## **6.6 Retail and Commercial Buildings**

Retail and commercial establishments form an irreplaceable part of everyday urbanism and built environments. It is important to ensure that accessibility is ingrained in every aspect of built environments, be it under public or private ownership and in diverse functional contexts.

Retail and commercial spaces include areas like shopping malls, shopping centres, bazaars, super or hyper stores, independent shops, etc. They remain spaces for purposeful activities of daily living as well as activities of recreation. Universal accessibility in all such establishments shall comply with following recommendations:

1. The entrance to any shopping complex/mall shall be levelled with a ramp. The security check spaces and features shall be accessible and allow diverse user groups.
2. All retail spaces and the associated external areas shall be universally designed and be accessible to all customers and staff members.
3. The circulation spaces should be well defined with the use of flooring patterns, difference in flooring by contrasting colors. The circulation spaces have to be unobstructed.
4. In large multi-story department

- stores and supermarkets, accessible elevators should be installed to provide access to lower and/or upper levels for all including those with mobility limitations including non ambulant.
5. Retail shopping areas, including malls and complexes, should have an accessible wayfinding system, providing information and directions to customers about each shop within the facility and their location.
  6. The wayfinding should also provide multi format information regarding the public amenities such as the washroom facilities, drinking water area, seating spaces etc. and the emergency egress routes.
  7. Commercial establishments are recommended to have provision for personal assistance or assistive technologies like wheelchairs or low height golf carts for persons with disabilities including others with reduced mobilities for convenience.
  8. The information desk shall make accessibility provisions for persons with hearing impairments through assistive technology or integrated systems like loop Induction system, close captioning systems, etc. The availability of the system shall be clearly shown with appropriate signage.
  9. Glass doors at the entrance of most retail outlets need to ensure coloured manifestation at three levels to ensure safety for people walking through it and to avoid head collisions.
  10. Public amenities should be family friendly. Diaper changing rooms in both male and female washrooms, universally accessible designed washrooms, baby feeding rooms for nursing mothers, drinking water should be provided at different levels, etc.
  11. The entrances of the shops or retail units should not have high thresholds. In case there is one, it should preferably be made accessible through ramped kerbs or should not exceed the height of 25 mm.
  12. Merchandise display areas should be placed at different height ranges to enable goods to be viewed and selected easily by people at a range of heights. Also, goods on display shall not become barriers to persons with mobility impairments especially in the access routes.
  13. The clothes rail should not be located more than 1200mm from the finished floor level.
  14. Angled mirrors can be placed above high shelves for visibility.
  15. All signage should be in contrast colour and large font. In clothes shops, at least one changing room should have a door with 900mm clearance and allow for a full 360 degree turn of a wheelchair.
  16. Wherever counters are present, either for viewing, exchanging, payments or for information, they all should be universally accessible to facilitate people who could be standing, wheelchair users or people with shorter stature.
  17. There shall be provision of an accessible fitting/changing room which has a clear access of 900mm and clear turning diameter of 1500mm for a wheelchair user to maneuver conveniently. There shall be transfer space and provision of a fold-down seat integrated with a backrest and it shall be securely fixed to the wall.
  18. The clothes hook shall be placed at a maximum height of 1200mm from the finished floor level. A call bell/buzzer can be installed for assistance seeking inside the fitting/changing room.





Image 6.38 Accessible retail space  
Photo Credits: Dr. Gaurav Raheja



# RELAY.







Image 6.39 Accessible book store  
Photo Credits: Dr. Gaurav Raheja

19. When some music is played via the public address sound system, it should be done at comfortable sound level. If it is played too loudly, it can be disturbing for people using hearing aids. It can also hinder hearing of normal speech and affect the communication among most people.

## 6.7 Cafeterias, Restaurants and Dining Facilities

1. New restaurants or parts of new restaurants and eating spaces should be accessible and persons with disabilities and elderly should use facilities and services.
2. The aisle widths should be at least 1200 mm wide to allow wheelchair users to maneuver comfortably.
3. Menu card should be available in alternate formats – bigger fonts, in Braille or having the audible version to be used in cases when the guests have visual impairments. Personalised menus using digital means and audio formats could also be explored to enhance accessibility of information.
4. In self-service counters such as in food courts in shopping malls, tray slides and counters should be mounted at 800mm from the floor for wheelchair users. Food shelves should be mounted at a maximum height of 1200 mm and aisle space of minimum 900mm should be provided.
5. The layout of the seating arrangement shall be designed and planned by ensuring seating spaces for users with mobility aids/devices.
6. Where buffet style food services are provided, displays should be accessible and mounted on surfaces no higher than 900 mm from the floor. Overhead display shelves should be no higher than 1200 mm.
7. Cantilevered tables or tables with





Image 6.40 Outdoor access to retail spaces

Photo Credits: Dr. Gaurav Raheja

straight legs at each corner are preferable to central pedestals that might restrict wheelchair access.

8. Stools and high tables are not suitable for wheelchair users. Low tables should be provided as well.
9. In case there is provision of outdoor dining space, they shall be made accessible with levelled surfaces or with ramps to allow access to wheelchair users, parents with baby.
10. High chairs shall be provided for families with infants.

## 6.8 Hotels and Hospitality Buildings

Hotels and other kinds of hospitality buildings need to adopt universal accessibility in their overall guest experiences. This includes planning for the guest experience from the entrance up to the other spaces, outdoors or indoors, the personal room of the guest or public areas

and dining spaces. Appropriate design and planning measures need to be taken to ensure best practices in accessibility to create an inclusive experience. The following measures are recommended:

1. Hotels, resorts and other hospitality buildings should include their accessible features in a digital format either through - websites or smartphone-based apps. They should specify the kind and level of accessible features that are part of their property to ensure clarity. This is helpful for diverse range of guests, especially those with special needs, in order to help them plan their visit in advance and make better choices based on their preferences.
2. The hotel building should be made directly accessible from the Parking / Drop-off. The entrance of the hotel shall be made levelled by providing a ramp as indicated in Section 3.10.
3. The reception counters along with waiting spaces such as lounges, etc.



- should be made accessible as per details in Section 4.3.
4. With regard to the minimum number of rooms that should be compliant with required number of accessible rooms, please refer to Table 6.2 (8). However, for smaller hospitality units or hotels, a minimum of at least two rooms along with attached washrooms should be universally designed with high support accessibility features and be able to accommodate diverse users. Other tactile features along with emergency alarm buttons shall be integrated into the design of these rooms and their internal spaces.
  5. The wayfinding layout should be designed to provide guidance and clear directions for visitors to find their way within the building. Tactile and Braille signs map should be provided visitors with impaired vision.
  6. The egress map should be placed at strategic locations along with emergency signage leading the way to exit routes.
  7. The guest room entrance doors shall have room numbers/names that are easy to identify and understand. It can be supported by raised characters or in Braille.
  8. Connecting rooms shall have accessible doors.
  9. All electronic controls and switches shall be provided in accordance with Section 4.15.
  10. A clear route shall be provided to the bed with a minimum clear space of 1500 x 1500 mm beside the bed.
  11. The washrooms in accessible rooms shall be designed in accordance with Section 4.9. There shall be a provision of emergency alarm with pull cord in



Image 6.41 Accessible cafe  
Photo Credits: Dr. Gaurav Raheja



ORDER HERE

GO GrabbnGo

FSTR  
FOOD BYELA

Now Enjoy



Multi Order

Order from multiple stores  
in one go

FSTR  
FOOD BYELA

GO GrabbnGo



Image 6.42 Accessible digital kiosk  
Photo Credits: Shreya Shetty



accessible washrooms.

12. It is preferred to have the accessible designed rooms on the Ground Floor which allows direct means of egress in case of any emergency.
13. In case the accessible room is located on higher floors in a multistoried building, egress maps or plans must be provided at strategic locations along the common path. Signage and wayfinding system should clearly direct all users towards the nearest emergency exit or refuge area.
14. Accessible rooms shall be provided with acoustic and visual fire alarms as well as an audible doorbell.
15. The bed shall be positioned to provide at least a 1500 mm turning space at the transfer side.
16. The clothes bar shall be at a height of 1100mm from the floor.
17. The closet shall have shelves installed at various levels between 450 mm and 1200 mm from the floor surface.
18. All common spaces like, restaurant, cafes, bar, gym, sauna, spa, banquet halls, conference rooms etc. shall be universally designed and be accessible to all user groups.
19. In case a person with hearing impairment is visiting the hotel, the hotel should make arrangements to share all relevant information like knocking at door and other messages from the front desk on a digital device like - Smartphone or Tablets to be made available by the hotel. It is advisable to provide the devices which come with vibration alarm features inbuilt in them.
20. The hotel should make provision of an Induction Loop System available for guests with hearing impairments. The TV should come integrated with the feature of closed captioning (CC)

whenever possible.

21. If a person with visual impairment is occupying a room alone, the hotel staff should orient them regarding the furniture alignment and facilities in the room.

## 6.9 Assembly Buildings

This category of building typology includes government assembly buildings, movie-theatres, congregation and lecture halls, spectator seating in sports centers, and other assembly halls with fixed seating. Designed and planned for masses, it's highly recommended to ensure inclusion of diversity in such buildings meant for mixed purposes of formal or informal nature. Universal accessibility however in the context of assembly buildings imply specific features in built infrastructure besides accessibility in an overall experience of watching film, stage performance, presentation, lecture or any other activity as part of it.

### 6.9.1 Seating and Signage

The number of spaces designated for wheelchair users in a seating area can be estimated according to the following Table 6.3

1. The accessible seats shall come with removable or flip-up armrests at row ends to accommodate a wheelchair user to transfer from their wheelchair or a person with limited ambulatory mobility.
2. The accessible seats shall be marked with the international symbol of access (ISA), whether as permanent seating spaces or removable seating areas.



Image 6.43 Accessible restaurant seating arrangement  
Photo Credits: Shreya Shetty

3. The accessible seats shall be marked with the international symbol of access (ISA), whether as permanent seating spaces or removable seating areas.
4. A level floor area for wheelchair users should be placed at row ends and should be scattered on different levels to have a variety of seating and viewing locations.
5. Accessible washrooms should be located close to seating areas and within a maximum distance of 150 meters.
6. When the lighting is dimmed, all steps and accessible routes are illuminated with the use of lighting strips for easy identification.
7. Directional Signage shall be installed at prominent locations to identify location of accessible seating spaces.

### 6.9.2 Stages and backstage

1. The backstage area should be made accessible and have the provision of an accessible washroom and an accessible changing room with minimum 1500 mm diameter for wheelchair maneuverability.
2. The stage should be accessible either by providing a ramp or a platform (wheelchair) lift or through an independent access route.

3. Backstage areas involving green rooms, etc. shall ensure accessibility.

### 6.9.3 Multiplex, Theatres, and Cinemas

Multiplex cinema and theatres as recreational assembly areas shall ensure accessible seating and sensorial accessibility as part of the overall experience. This shall include development like accessible parking, mobility and circulation systems, etc. Additionally, for overall accessibility, multiplex theatres and cinemas, shall fulfil the following requirements:

1. In the case of performances containing audio (cinema, opera, conferences, etc.), closed captioning system/subtitles and/or sign language should be provided for people with hearing impairments.
2. In case the performance contains action (movies, theatre, opera, etc.), an audio description system should be provided for persons with visual impairments.

### 6.10 Judicial and Legal Buildings

Judicial and legal buildings comprise an important character of public dealing serving a wide range of national populations. This includes consumer courts, session courts, district courts and

Table 6.3 Accessible Seating Ratios

NUMBER OF SEATS IN A SEATING AREA	NUMBER OF REQUIRED SPACES FOR WHEELCHAIR USERS
Upto 600	6 i.e. 1 per 100
Upto 1000	6 + 2
Over 1000	8 + 1 for each additional increment of 1000 seats





Image 6.44 Accessible seating in a convention center  
Photo Credit: NIUA, New Delhi

several others as specified in Table 6.1. A judicial building complex shall need to incorporate accessible features in its overall implementation, from the stage of planning the complex, to planning external elements like parking pedestrian mobility and entrances leading to the internal spaces. The following general recommendations must be considered:

1. It is recommended to plan and design judicial or legal buildings to ensure accessible spaces ranging from parking and external environments to entrance spaces and leading to accessible services and infrastructure within these court complexes.
2. Several court complexes with high plinths or steps shall require stair lifts or other alternative means to make them accessible for persons using wheelchairs or the elderly, etc. It is important to provide an accessible experience in public areas like court rooms, chambers of legal experts, lawyers, judges and other officers of a court system.
3. Accessible circulation remains a key factor in enhancing the inclusivity of court systems along with waiting areas and their functional work environments. It is important to ensure communication accessibility at various levels of legal proceedings, hearings and other sensitive dimensions of judicial or legal environments.
4. Accessible witness boxes, hearing chambers and accessible seating spaces shall further enhance accessibility of courtrooms in judicial building.
5. Adaptation of new technologies with closed captions, sign language support are recommended to be made part of judicial and legal functioning systems.

## 6.11 Urban Public Spaces

Urban public spaces are an integral part of our urban environment. They are the core of a city's public life and are often seen as a public asset that produces various public benefits and opportunities. India has a wide variety to offer when it comes to public spaces like – riverfront developments, riverside ghats, lakeside developments, community parks and gardens, beaches, street plazas, commercial complexes with a range of business and recreational activities etc. These spaces directly contribute to positive health outcomes for all users and build a stronger sense of community within neighborhoods. Public spaces can also positively impact social well-being and enhance community resilience by shaping people's perceptions of social connectedness, trust, welcome-ness, and safety when they're in those spaces. Universal accessibility features and good public amenities shall encourage and empower a wide range of user groups to use these urban public spaces namely, persons with disabilities, the elderly population, women, families with young children etc. To ensure that our public spaces are inclusive and accessible for all, the following recommendations are being proposed.

1. It is recommended to provide information about a place which helps people to plan their visit and assess potential challenges via digital platforms like websites and smartphone-based applications. Information should always include references to accessibility and facilities like nearest public transportation routes, car park areas, toilets visiting hours etc.
2. The urban public space should be well integrated with the local transportation model which allows first and last mile connectivity to all users up to the entrance of such

- facilities. It is highly recommended to transform urban public spaces to become pedestrian friendly, with adequate support through para transit and non motorized transport systems preferably with low floor chassis.
3. If there is a car park facility available, there shall be reserved parking spaces for persons with disabilities located close to the strategic locations like the entrance.
  4. The entrance to various urban amenities should be as far as possible free of any obstruction, it should provide seamless mobility through ramps with gentle slopes wherever there is any change of level on the access path. TGSi tiles should be incorporated from the entrance to all important locations and amenities within the complex/site.
  5. While planning and designing the paths within the spaces, alternative routes shall be planned which allows the user to choose their destination without having to go around the entire site.
  6. The wayfinding system should incorporate a comprehensive system of signage within the public space which provides -
    - a. Information signs giving relevant knowledge about the place to the visitors.
    - b. Direction signs which lead the visitors to all places of interest and public amenities.
    - c. Identification signs which help visitors to identify each location on the site.
    - d. Emergency exit signs leading the visitors to the nearest exit.
  7. The wayfinding system shall be designed to appear integrated with the overall look and ambience of the space at the same time it should be easy to locate and legible
  8. The access path should be free of any obstructions such as street furniture, signage, and lighting poles etc.
  9. The material selection for both indoor and outdoor flooring should be chosen keeping in mind the high pedestrian traffic. The flooring should allow smooth maneuverability for wheelchair users and should be non-slip.
  10. For outdoor public spaces, there should be a provision of shaded spaces by designing landscape elements like pergolas and shaded walkways made by natural vegetation.
  11. It is to be ensured by the management and operations team of the public space that all access paths are well maintained and provide unobstructed access.
  12. There shall be adequate resting seats with priority seating for persons with disabilities, elderly, children, expectant mothers etc.
  13. There should be adequate illumination throughout the public space which avoids glare and gives uniform lighting on the access path.
  14. Any change of levels should be marked by the use of contrasting colors in the flooring materials/ surfaces.
  15. Public amenities like washrooms should be provided for Persons with disabilities along with family friendly washrooms should be provided. Accessible drinking water facilities and litter bins should also be well integrated in urban public spaces.
  16. The management should consider providing wheelchairs on loan for larger public spaces which will enable and ease the movement of Persons with disabilities and elderlies in these spaces.





Image 6.45 Accessible open air theatre  
Photo Credits: Dr. Gaurav Raheja





Image 6.46 Accessible public space features: Dilli Haat, Delhi  
Source: <https://www.thehindu.com/news/cities/Delhi/dilli-haat-to-reopen-today/article31984774.ece>





Image 6.47 Accessible public space features: Garden of five senses, Delhi  
Source: <https://www.journeymart.com/de/India/Delhi/new-Delhi/garden-of-five-senses.aspx>





Image 6.48 Accessible public space features: Chandni Chowk, Delhi  
Source: <https://timesofindia.indiatimes.com/city/Delhi/chandni-chowk-gets-a-new-look-but-may-miss-i-day-show/articleshow/70578832.cms>



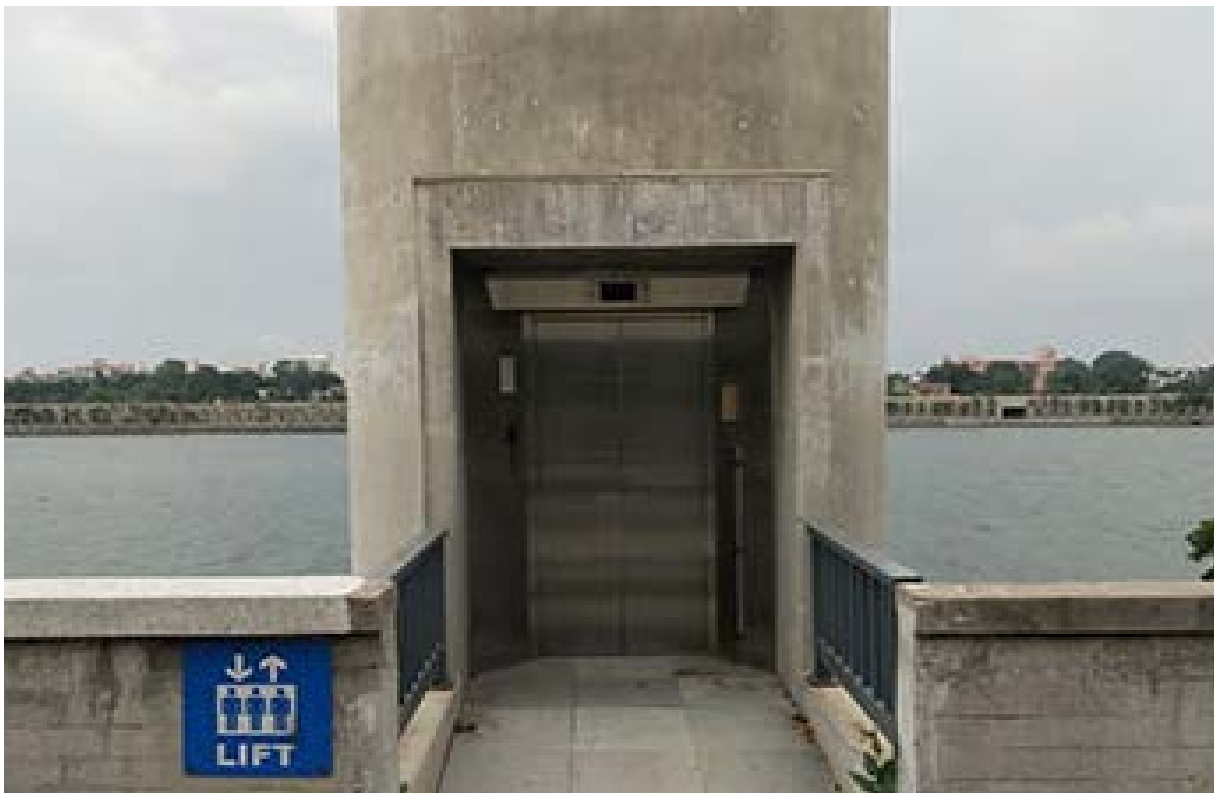


Image 6.49 Accessible public space features: Sabarmati Riverfront, Ahmedabad  
Source: <https://mobile.twitter.com/nandinibas16>



Image 6.51 Accessible public space features

Source: <https://sabarmatiriverfront.com/riverfront-park-subhash-bridge-opened-to-public/>

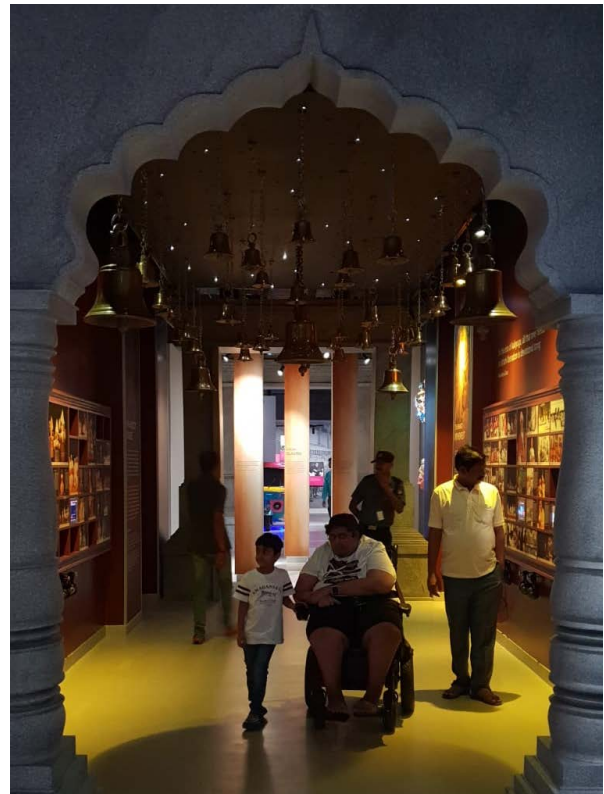


Image 6.50 Accessible public space features: Indian Music Experience Museum

Photo Credits: Shreya Shetty





Image 6.53 Accessible seating  
Photo Credits: Dr. Gaurav Raheja



Image 6.52 Seating provision on the street  
Photo Credits: Dr. Gaurav Raheja





Image 6.54 Accessible smart public toilet

Photo Credits: <https://www.pnnews.com/automated-public-toilets-by-smart-city-ahmedabad/>

17. Public beaches can be made accessible for wheelchair users, families using baby prams and other users of assistive mobility devices by providing an unobstructed access path which directly connects the seafront from the adjoining road.
18. There shall be SOS features like provision of medical emergency systems, defibrillators on the site which can be used by the visitors.
19. All public spaces should be designed and planned to be vandalism free zones. The selection of furniture, lighting features, litter bins, etc. for all external public spaces should be done in a way that it is least impacted by harsh climate conditions.

## 6.12 Sports Buildings and Infrastructure

Sports complexes and arenas need to integrate accessibility across all scales and typologies. This includes indoor sports complexes and outdoor sports areas meant for diverse user groups and age groups. Accessible entrances, reserved parking for persons with disabilities, ticket counters and access to seating form some of the crucial components for a sports building to be completely termed accessible and compliant.

1. Universal accessibility in sports infrastructure implies accessibility in the physical infrastructure of the sports complex, along with along with specific play equipment and coaching services for enhancing the inclusivity of all in sports arenas.

2. Grab rail supports in stepped environments of sports arenas are highly recommended to include individuals with high support needs.
3. Sports zones form a centre of physical activity, a fitness based orientation and a recreational activity for the passive spectators as well. Accessibility therefore needs to be understood, executed and maintained at all levels.
4. Live commentaries, screens with sub titles and multi format information systems using technologies can further enhance accessibility in sports environments.
5. Sports halls should be fully accessible in compliance with the external and internal elements specified in Chapters 3 and 4 4 and the signage and wayfinding systems described in Chapter 5.
6. While retrofitting and designing swimming pool facilities, at least one shower room, one washroom and one changing room per facility should be accessible to a wheelchair user.

### 6.12.1 Seating spaces

1. Wheelchair spaces must be connected to accessible routes and should be located at different tiered seating levels, similar to the regular seating provision.
2. There should be good sight lines from all seating positions so that viewers are able to see the speaker, a person assisting with sign language, the projection screen, and the presentation, performance or sports event.
3. Where two or more wheelchair spaces are provided, at least two wheelchair spaces should be located side by side to allow two wheelchair users to sit together and also alongside fixed seats.

### 6.13 Religious Buildings

India hosts population from diverse religious faiths and beliefs like Hinduism, Islam, Christianity, Sikhism, Buddhism,



Image 6.55 Accessible sports infrastructure  
Photo Credits: Rohit Guliani





Image 6.56 Accessible Religious building complex  
Photo Credits: Aishwarya Isha

Jainism, etc. To facilitate and support individual aspirations of religion, the built infrastructure of these places of worship like Temples, Mosques, Churches, Gurudwaras etc. shall ensure universal accessibility provisions as part of their experience. This shall go a long way in creating social inclusion through religious places. It is important to note that manifestation of accessibility is critical while retaining the sanctity of the religious principles of a place. To achieve accessibility to all user groups, the following recommendations should be followed

1. The Prayer Hall or Holy Shrine shall be connected directly to the main entrance/parking. In case there are steps, the entrance route should be made accessible with the provision of a ramp with handrails, a platform lift, or an elevator, as applicable.
2. There should be provision of a locker system for storage of personal items and a well managed footwear storage facility near the entrance of the religious complex.
3. Wherever it is expected to walk long distances or high levels, adequate support through grab rails alongwith resting spaces shall be provided in religious shrines or complexes.
4. Integration of assistive technologies like platform lifts, stairlifts, sensory technologies for enhanced experience, etc. is highly recommended to enhance accessibility of religious places.
5. Seating spaces shall be provided at entrances and at other locations where people are required to remove their shoes.
6. Queue management system shall be incorporated to guide and assist devotees waiting in line to reach the central Prayer Hall. Preference should be given to the elderly, persons with disabilities, expectant mothers, and

families with infants to reduce their waiting period.

7. There should be uninterrupted access to spaces like Langar/ Prasad Hall and ablution areas for people belonging to various user groups.
8. It is preferable to have facilities like wheelchair(s) or other assistive technologies to aid mobility and support for use in premises by persons with disabilities or elderly.
9. In case carpets are used for flooring in the indoor spaces, the carpets should be flushed with the finished floor level and firmly held on plane surfaces and steps.
10. Colour contrast shall be adequately kept in mind while keeping the religious semantics intact.
11. Public participation can play a vital role in enhancing accessibility experience of religious places and shrines.

#### **6.14 Recreational Buildings and Spaces**

Recreational buildings and spaces under the multicultural contexts of India need to embrace inclusion and accessibility in many ways to accommodate diverse user groups such as persons with disabilities, families, children, elderly, etc. Various kinds of recreational environments like museums, cultural centres, exhibition halls, art galleries, amusement parks, etc. shall require specific accessibility measures in their respective context. Built environments offering recreational services with open and enclosed areas need to implement the following in light of accessibility provisions:

In recreation buildings and amusements parks, the following requirements shall be fulfilled:



1. Queue management shall be implemented
  - a. When queuing is required to enter or use a facility, a priority line shall be provided for people with functional limitations.
  - b. Moreover, when people are standing in line, signs and sound announcements should inform them of the expected time of waiting to enter the facility. Seating places shall be provided for people that cannot stand in a line. The number of seats will be defined according to the expected age and number of users.
2. When the nature of the facility requires seating places, an adequate number of accessible seating spaces shall be provided. These seating spaces have to follow the requirements of auditorium seating spaces.
3. Amusement facilities should ensure equal use for a maximum number of people to the highest extent possible.
4. If different amusement facilities are provided in the same recreational building or amusement park, the majority of them shall be accessible for a large number of users.
5. Depending on the facility dimensions, wheelchairs or other personal mobility devices shall be available at the users' disposal.
6. In recreational spaces with visual and performing arts or cultural performances, accessible formats of information shall be ensured especially for persons with visual and hearing impairments.
7. Access in circulation routes and viewing experience accessibility shall remain critical as an experience of recreational environments.
8. Adequate seating and grab rail



Image 6.57 Accessible heritage building  
Photo Credits: Mridula D



support shall be provided in places there is a need to walk across large recreational sites.

### **6.15 Heritage Buildings and Sites**

India is a unique nation with rich heritage in both tangible and intangible forms. Enhancing accessibility to our heritage through built infrastructure and technological interventions requires sensitive planning supported with frameworks of implementation. This may be done in due consultation with heritage conservation experts along with accessibility experts to find innovative means of creating access in challenging contexts of our rich heritage. The following recommendations shall be kept in view to implement a universal accessible experience to heritage sites, buildings, complexes and environments, be it spiritual based, nature based, culture based, structure based or recreation based. One of the aspects of cultural accessibility is to provide multi lingual support alongwith visual support to have an inclusive information design.

Visitors from far and beyond travel to see the remains of our history. The Heritage built environments may include historical monuments, places of historic importance, archaeological sites which have unique tales to be told and explore. While planning the access in such sites, it is important to respect the tangible & intangible elements and use sensitive means of accessibility for the built environment. Everyone should feel welcomed to witness the history of India with ease and dignity.

1. Information regarding the accessible features of the complex should be made available in the form of online websites or mobile based apps or other digital interfaces

with accessible features which allows visitors to plan their visit and movement before arrival.

2. Historical buildings/sites should respond to the universal design approach to ensure accessibility for diverse user groups including persons with disabilities. In cases when it's not feasible to achieve accessibility in the entire heritage site or heritage building complex, it must be ensured at least a part of it is made accessible to visitors along with accessible augmented and virtual reality experiences of the place.
3. There shall be provision for online ticketing and the ticket vending machine should be accessible for all.
4. The information center should provide audio guide with multilingual support to enable transfer of knowledge for all visitors.
5. Guided tours with sign language support is highly recommended to ensure inclusion of persons with hearing impairments.
6. The signage should be designed with clear directions / instructions for the visitors. There shall be provision of tactile maps for persons with visual impairments and apt graphic representations in colour contrast for wayfinding.
7. The newer built visitor facility buildings like interpretation center, washrooms and cafeterias should be universally accessible while embedding various features supporting diverse user needs including persons with disabilities.

### **6.16 Industrial Buildings**

Industrial buildings like factories, workshops, etc. are recommended to make their work environments more

inclusive and accessible to a wide ranging users who might already be part of their workforce. Universal accessibility would enhance inclusion of persons with disabilities in the workforce and shall become more inclusive and diverse for all others. An industrial building with accessibility implies having an accessible work experience starting from entering the factory premises to circulation spaces and other utility and ancillary areas of the premises.

1. Industrial work spaces should reflect sensitivity in the sanitary provisions for all genders along with unisex accessible washrooms. In certain industry and work spaces where women work, provision of nursing rooms and children play area is recommended.
2. Role of colour contrast between industrial machines, flooring and work environment is critical for safety of workers. It is therefore recommended to implement colour schemes and material palettes that can enhance work efficiency alongwith accessibility.
3. Emergency systems and evacuation protocols shall consider accessibility as an integral part of industrial building planning and design. Clear access to outdoor assembly areas in case of mishaps, etc. is a desirable activity.
4. Accessibility services in an industrial system shall ensure access to work spaces, resting spaces, building interiors, common dining facilities like mess, canteen, alongwith other ancillary facilities.
5. Specific industries need to abide by their accessibility guidelines to ensure inclusive work environments and provision of equal opportunities to persons with disabilities and others.

## **6.17 Bank ATMs and Vending Machines**

### **6.17.1 Bank ATMs**

Bank ATMs are recommended to comply with the following accessibility provisions:

1. The ATM room should have a levelled entrance by providing a suitable ramp along with handrails on both sides for support.
2. There shall be sufficient landing space for a wheelchair user to park while waiting their turn to enter the ATM room.
3. Provision of TGSi tiles leading up to the ATM machine from the entry point of the ramp.
4. The entrance door to the accessible ATM room should be minimum 900 mm wide.
5. Maneuvering space for a wheelchair turning diameter of at least 1500 mm should be provided to access the ATM machine whether installed in a room or in an open zone.
6. There is at least one frontal or lateral interaction space ensuring privacy.
7. If the ATM machine protrudes from the vertical wall, edges must extend to the floor in all its plane projection.
8. Floor surface should be non-slip and allow for easy wheelchair maneuverability.
9. The ATM machine's screen and keyboard should be visible from the height of 1000 mm above the floor level.
10. There shall be no reflections or glare on the ATM machine screen.
11. All the controls and buttons shall be provided in the range of 400 to 1200 mm from the floor level. The machine shall maintain a minimum distance of 600 mm from any corner.



Image 6.58 Accessible entrance to a bank ATM

Source: <https://www.localguidesconnect.com/t5/General-Discussion/Accessibility-of-India-Accessible-Gwalior/>

12. The control buttons should have embossed text description and Braille signs. They should also have colours contrasting with the background surface.
13. There shall be tactile symbols and graphics which indicate the card inserting slot and the direction in which the card shall be inserted.
14. The machine should be integrated with audio support for all information which can indicate validation of access to the service and to alert the user in case the card or the money has not been collected from the machine.
15. When banking services, identification or validation cards have to be used, the device must meet the following requirements:
  - a. The card slot is located at a height between 800 mm and 1200 mm from the floor level and is bevelled to facilitate its introduction.
  - b. It has contrasted colour with the background surface. Tactile symbols and graphics that represent the card inserting direction must be included.
  - c. It must have a visual and acoustic system to indicate validation of access to the service and to alert in case in case the card or money has been forgotten.
  - d. It shall provide audio for all information.

### 6.17.2 Vending Machine

1. The coin slot must be located at a height of 1200mm or less
2. It should have a clear floor space of 900 X 1200 mm.
3. Operating buttons should have raised numbers and should be in contrasting colours.





Image 6.59 Accessible ATM Machine  
Photo Credits: Dr. Gaurav Raheja

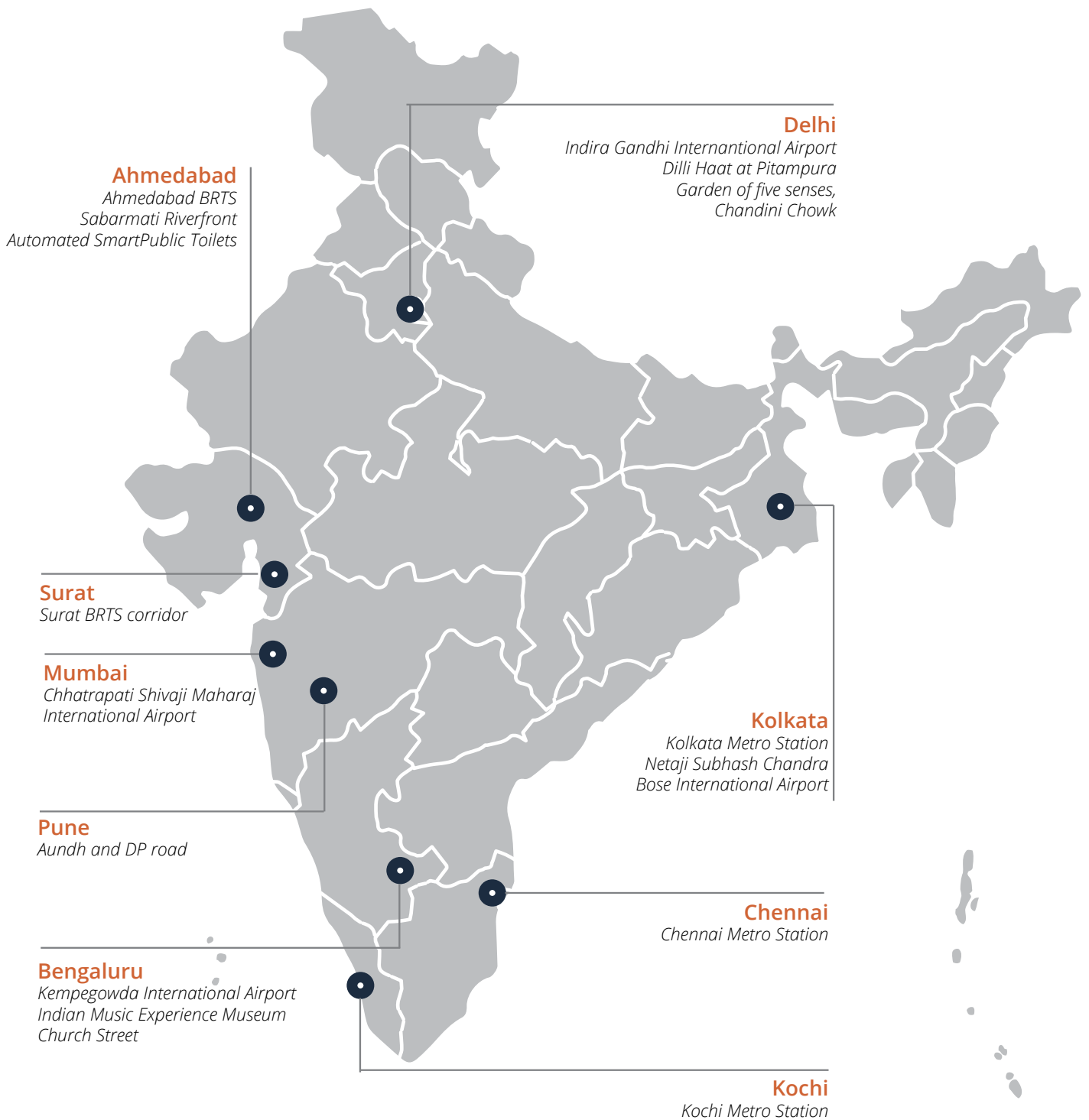


Figure 6.7 Accessibility examples from India











---

---

---

---

---

---

---

---

---

---

---

---

# Building Operations & Maintenance

- 7.1 Building Access Strategy
- 7.2 Building Management
- 7.3 Emergency Evacuation Needs
- 7.4 Building Operations
- 7.5 Accessible Technologies
- 7.6 Retrofitting





*You have a responsibility to  
make inclusion a daily thought,  
so we can get rid of the word  
'inclusion'*

*-Theodore Meffi*



# BUILDING OPERATIONS & MAINTENANCE

# 7

Accessibility is a dynamic, real time quality of any built environment and user experience. In order to achieve a seamless and entire accessible experience in our built environments, it would require to enforce universal design approach in every aspect.

Incorporation of universal accessibility is not merely restricted by design conceptualisation or physical implementation in built environments. Rather, it extends to their very management and operations. A built environment experience is judged by the overall perspective of the user or visitor engagement and on the degree of independence one can achieve ones activities in relation to the space to those spaces.

The role of technology, manpower training and capacity building along with constructive reforms in built environment policies of each institution, organisation, etc. shall play a vital role in transforming the accessibility culture of our built environments. The following sections guide us further in creating accessibility in environments.

The section on accessibility elements and features shall be included and revised in the Delhi Schedule of Rates (DSR) with detailed specifications with regard to the provisions suggested in the New

Guidelines and shall be made as Schedule of Rates (SOR) Items.

The bureau of Indian Standards (BIS) shall prepare the standards for materials to be used in fixtures and fittings besides other appurtenances with detailed testing procedures essential for the approval of products to be used for universal accessibility.

## 7.1 Building Access Strategy

Every built environment needs to prepare an Access Strategy for its management of services, operations, and emergency protocols. It needs to have a well laid out structure for priority services and manage of all external and internal elements of the built environment.

Building Operations works at three levels - information, function, and maintenance. All three should be in sync to provide an overall satisfactory user experience. Periodic assessment of built environment for accessibility must also be carried out with the aid of Access Audits.

Every organisation or built environment entity shall need to implement an integral access policy for handling its day to day operations, including parking, security, entry management along with other

internal services like circulation, lifts, sanitation and cleaning services.

appropriate training, and that customer service is exemplary throughout the organization.

## 7.2 Building Management

The accessibility and usability of a building relies as heavily on good management as it does on the physical characteristics of the environment. A well-managed building is welcoming, safe and convenient for everyone to use. Good management and effective customer service can improve the accessibility and usability of even a poorly designed building. By contrast, poor management, and a lack of attention to customers' need can compromise the most accessible venue.

Building management encompasses a range of practical tasks including cleaning, maintenance, servicing, and repairs. It also covers operational issues such as customer service, staff training and emergency evacuation procedures. All these issues contribute to the correct functioning of a building and ensures that its facilities are accessible, useable, and understandable to all. Following are good practices for maintaining a good building management.

1. Preparing an Access Handbook to record and explain features of a building that are key to universal design for people regardless of their age, size, ability, or disability.
2. Ensuring the access handbook is available for all staff to consult.
3. Good management practice shall ensure that suitable emergency evacuation procedures are in place, regularly reviewed, practiced, and communicated effectively to everyone who uses the building.
4. The Access Handbook will ensure that staff and volunteers receive

Management plans shall be developed and implemented to ensure that all internal and external environments remain safe and accessible during the lifetime of the facility. Management plans shall be updated as required to reflect modifications to the facilities or changes in use or occupation. Management of external and internal environments will satisfy the performance objectives if the following recommendations are followed.

### 7.2.1 External Areas

1. Information regarding parking provision is made available to prospective customers and visitors. Designated parking bays and sitting down areas are monitored, and unauthorized users are controlled and penalized.
2. The usage of designated parking bays is monitored, and additional spaces are made available if demand increases.
3. There is a regular monitoring and maintenance program that ensures pedestrian routes remain clear of obstructions, free of sand, water, and other loose materials.
4. The surfaces of pedestrian routes are monitored and maintained to ensure that there are no uneven or damaged areas that may present a tripping hazard. Those modifications and / or maintenance work do not result in a reduction in accessibility.
5. There is a regular monitoring and maintenance program to ensure that adequate lighting levels are maintained to all areas and in particular in external steps, ramps and access routes.

6. In shared space areas, traffic speed limit must be enforced and delivery and parking restrictions must be applied to ensure that pedestrians can use the area safely.

### **7.2.2 Internal Areas – General**

1. Access control systems are monitored and tested on a regular basis with respect to door operation and communication facilities.
2. Powered door opening and closing systems are monitored and tested on a regular basis to ensure designed operational speeds and activation timings are maintained.
3. Manual door closers are monitored and tested on a regular basis to ensure the opening force is within the required limits.
4. Door furniture is kept clean and free moving.
5. Hold open devices linked to the fire alarm system are monitored and tested on a regular basis.
6. The staff shall always be on call to entry-phone or access control system queries and / or problems and to provide assistance if required.
7. Lobbies, reception areas, lift lobbies and circulation routes are maintained free of obstructions, including deliveries.
8. Adequate space is maintained in cafés and restaurants between movable tables and chairs to ensure ease of access for all users.

### **7.2.3 Lifts**

1. Regular inspections, statutory testing and servicing is carried out.
2. Alternative arrangements are provided and communicated in the

event of a lift failure, or a lift being taken out of service for maintenance.

3. Emergency call and communication systems are monitored and tested on a regular basis to ensure that they are always fully operational.
4. Regular checks are carried out to ensure that lift car and floors are aligned at every landing level.
5. Minimum level of illumination to be maintained at 100 Lux in Lifts for proper visibility.

### **7.2.4 Sanitary Facilities**

1. There is a regular inspection, cleaning, re-stocking, and maintenance plan for all sanitary facilities.
2. The time and date of the last inspection is displayed within the sanitary facility.
3. Where there is a requirement to keep accessible toilets or changing places locked, a key is always available nearby and there is a clear notification of where it can be obtained.
4. There are regular checks to ensure that the assistance alarms are fully operational and accessible.
5. Building managers ensure that trained staff are always available to respond to assistance alarms and provide appropriate and effective assistance.
6. Information regarding hoist operation and sling compatibility is provided in Changing Places toilets.
7. There are regular checks to ensure that the transfer space in accessible WCs is not obstructed and wheelchair maneuvering spaces are maintained free of obstructions.

### **7.2.5 Surfaces**

1. There is a regular inspection, cleaning,



and maintenance plan.

2. Where modifications or redecoration is carried out, the works achieve the original performance objectives.

### **7.2.6 Building Services**

1. There is a regular monitoring and maintenance program to ensure that adequate lighting levels are maintained in all areas.
2. Light bulbs are replaced as soon as they have failed, and fluorescent tubes are replaced if they start to flicker.
3. Regular inspections, statutory testing and servicing is carried out on all equipment.
4. There is a regular inspection, cleaning and maintenance plan for all air-conditioning, mechanical ventilation, and heating systems.
5. Windows are cleaned on a regular basis and blinds and solar control devices are inspected, cleaned, and maintained on a regular basis.

### **7.2.7 Communications**

1. Information regarding building facilities and access arrangement is available in a range of formats and is updated on a regular basis.
2. Pre-visit information regarding access and facilities is available on a web site and / or a telephone number is provided for or an audio description of the services.
3. Hearing enhancement and public address systems are monitored, tested, and maintained on a regular basis.
4. There is a system in place for the loan of headsets for infrared and radio hearing enhancement systems, where provided, including retrieval,

cleaning, testing and security.

5. Signage and communication systems are updated as required to respond to changes in the buildings' occupants, services, and facilities.
6. All new signage is integrated with the existing.
7. Temporary signage is removed as soon as it is no longer relevant.
8. Signage removed for redecoration is replaced correctly.

### **7.2.8 Means Of Escape**

1. There are regular checks of internal and external emergency exit routes and access for fire fighting vehicle is always available.
2. Regular inspections, statutory testing and servicing is carried on fire alarm systems.
3. Building evacuation tests are carried out on a regular basis to ensure that fire marshals are properly trained, and all staff are implementing emergency evacuation procedures and duties correctly.
4. There is regular liaison with vulnerable users and visitors to agree and update personal emergency evacuation plans.
5. Regular fire drills must be carried out to ensure a clear understanding about evacuation systems among the occupants

### **7.2.9 Staff training and Capacity Building**

Everybody in an organisation contributes to the efficient running of a building. The building management is responsible to sensitise and train their staff regarding the operations and maintenance of any building or built environment. Staff training can be successfully conducted in



Image 7.1 Emergency exit door  
Photo Credits: Dr. Gaurav Raheja

the following ways:

1. All members of staff in an organisation, including volunteer staff, are recommended to undertake appropriate training to know and understand the difficulties faced, what facilities or measures promote access to all, regardless of age, size, gender, ability, or disability.
2. This training could be a one-to-one training by a supervisor, use of video or e Learning tools, contractors, or formal classroom training. Staff and volunteers should be fully aware of features within buildings and environments that help to facilitate universal design for people, such as unobstructed circulation routes, the availability of suitable seating and clear signage.
3. Alert response mechanism to emergency alarms like the ones placed in washrooms in case of situations that require assistance shall be part of their training and capacity development.
4. Staff should also be aware that certain actions may inadvertently create barriers to access, such as placing large waste bins in the transfer area of an accessible toilet, removing or covering signage during redecoration, placing planters in staircase next to railings, or obstructing circulation routes with boxes or surplus furniture.
5. Where items of equipment are installed, such as text phones, platform lifts, and induction loops, staff should be fully trained in the use and maintenance of this equipment.

### **7.3 Emergency Evacuation Needs**

All buildings and built facilities should

have a well laid out plan for Emergency Egress in case of life-threatening situation caused by a medical emergency, fire, earthquake, or some other form of natural disaster. Fire and life safety systems are especially important in facilities providing specialized services or programs to seniors and persons with disabilities. Senior citizens and people with disabilities are groups at greater risk and may require additional assistance or accommodation to evacuate a facility. Provision of accessible means of egress from all public use areas and facilities is as vital a component as accessible ingress. The following requirements shall be followed as part of a building's emergency evacuation system. Reference to evacuation protocols for accessibility shall be clearly established for each Building Typology/Usage.

#### **7.3.1 Evacuation Plans**

1. Evacuation plans that clearly indicate the designated emergency evacuation routes as well as location of refuge areas should be displayed at all public areas of the building, that address the needs of users with varying disabilities.
2. Ensure the base of evacuation plans are posted at a maximum height of 1200 mm from the floor.
3. Ensure evacuation plans incorporate a font size of 14-point (minimum) in San serif font.
4. Ensure evacuation plans are available in alternate formats
5. Provide signage to identify evacuation plans.
6. These should contrast strongly against the background. Where possible, these should incorporate raised letters and tactile routes, and Braille for benefit of persons with



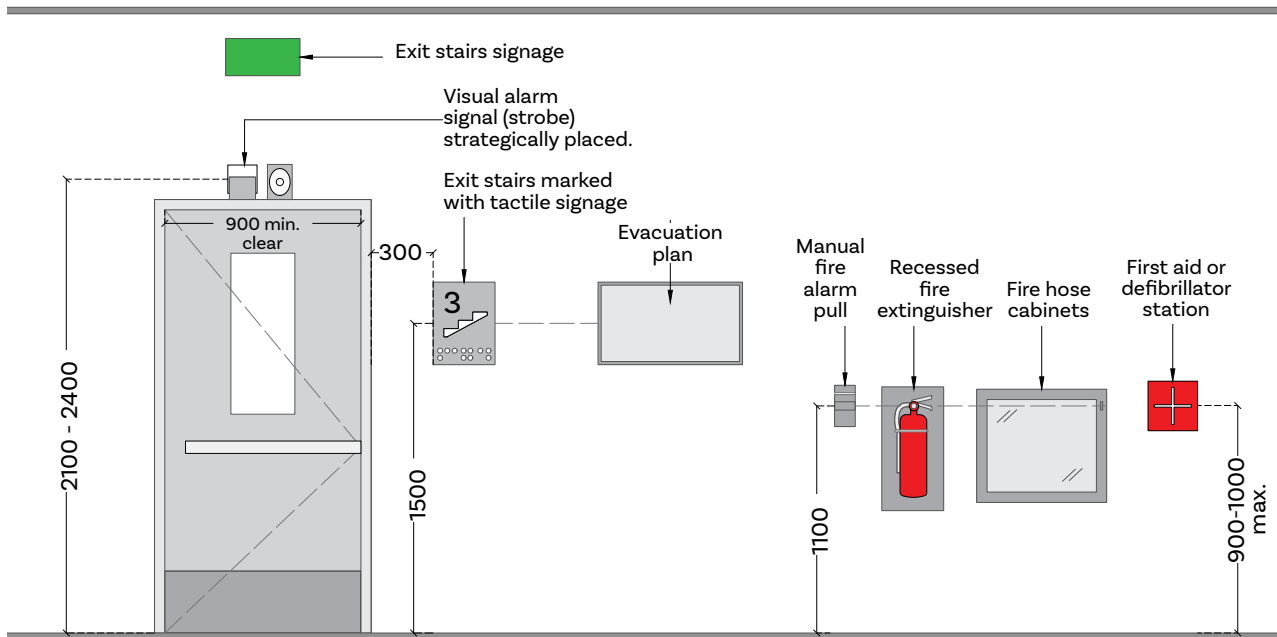


Figure 7.1 Fire Safety and Evacuation Features: Elevation View

2. To be considered accessible, the exist stairway shall have a minimum clear width of 1500 mm between handrails and shall either incorporate an area of refuge complying with Section 9.5 within an enlarged floor-level landing or a horizontal exit.
3. Stairway identification photoluminescent signage is provided as well as stair markings.
4. Orientation and direction signs should be installed frequently along the evacuation route, and these should preferably be internally illuminated.
5. The emergency lighting provided by traditional overhead emergency lighting luminaries, conforming to the Indian Standard IS: 9583-1981: Emergency Lighting Units, is acceptable for people who are visually impaired.
6. Exit signs shall be in accordance with IS: 4878-1968. Exit signage should also be available in tactile format in

the evacuation route.

7. Along the emergency route, tactile floor guidance for persons with visual impairments should be provided.

Note: Fireproof doors along circulation paths that are not exclusively egress routes generally require a force greater than 25 N to operate, rendering several disabled people dependent on others to negotiate these doors. While it is essential to cater safety measures for unpredictable emergencies, it is also important to provide an accessible environment to disabled persons. Consider holding the doors open with magnetic catches or floor springs that are connected with the fire alarm system

### 7.3.4 Provision of Refuge Areas

1. A refuge area, also known as an area of rescue assistance, is a place of relative safety where persons who may not be able to negotiate

inaccessible egress routes may await rescue assistance.

2. Where a required exit from an occupiable level above or below a level of accessible exit discharge is not accessible, refuge areas shall be provided on each such level (in a number equal to that of inaccessible required exits).
3. Every required area of refuge is to be accessible from the space it serves by an accessible egress route.
4. Every area of refuge shall have direct access to an exit stairway.
5. Each area of refuge must be separated from the remainder of the storey by a smoke barrier having minimally two hour fire resistance rating. Each area of refuge is to be designed to minimize the intrusion of smoke.
6. The size of the refuge shall have at least two accessible areas, each being not less than 750 mm by 1200 mm. The area of rescue assistance shall not encroach on any required exit width. The total number of such areas per story shall be not less than one for every 200 persons of calculated occupant load served by the area of rescue assistance.
7. All stairs next to the refuge area should have a clear width of 1500mm between the handrails.
8. A method of two-way communication, with both visible and audible signals, shall be provided between each area of rescue assistance and the primary entry.
9. Provide separate emergency lighting and ventilation systems supported by a backup generator.

### 7.3.5 Signage

1. Each area of rescue assistance shall be identified by a sign, which states,

"REFUGE AREA" and displays the international symbol of accessibility.

2. The sign should be illuminated when exit sign illumination is required.
3. Signage should also be installed at all inaccessible exits and where otherwise necessary to clearly indicate the direction to areas of rescue assistance.
4. In each area of rescue assistance, instructions on the use of the area under emergency conditions shall be posted adjoining the two-way communication.

### 7.3.6 Alerting Systems

In emergency situations, it is critical that people are quickly alerted to the situation at hand. For persons with disability the following needs to be considered:

1. Audible alarms with "Voice Instructions" should be installed that can help guide them to the nearest emergency exit. As an alternative to the pre-recorded messages, these alarms may be connected to central control room for on-the-spot broadcasts.
2. Non - auditory alarms (visual or sensory) to alert persons with hearing impairments should be installed at visible locations in all areas that the building users may visit (including toilet areas, storerooms etc.). Non-auditory alarms include flashing beacons.
3. Integrate visual alarm signals with required audible fire alarm system, including during retrofit projects where feasible.
4. These should be adequately contrasted in colour and tone from the background wall and should be labelled with raised letters and in Braille.

5. Mount appliance at 2100 mm (minimum) above the floor level within the space or 150 mm below the ceiling, whichever is lower.
6. Where visual alarm signals are provided in any common space, public corridor, hallway, lobby, or room, ensure they are placed no more than 15 metres apart, on the horizontal plane.
7. Install visual alarm signals so that the signal from at least one device is visible throughout the floor area or a portion of it in which they are installed and;
8. Ensure the intensity of the visual alarm signal raises the overall light level sharply, but it should not be so intense to be unsafe for direct viewing.
9. Ensure a flash intensity of 75 candela (minimum) with a flash rate between 1 Hertz (minimum) and 3 Hertz (maximum); and
10. Synchronize visual alarms that are in the same proximity to flash at the same time.



Image 7.2 LED Beacon



Image 7.3 Fire Alarm Bell



Image 7.4 Fire Alarm





Image 7.5 Cardiac emergency  
Photo Credits: Dr. Gaurav Raheja

### 7.3.5 Public Address Systems

In large spaces a series of speakers positioned at designed intervals provide a sound volume that is appropriate to the environment and circumstances in which it is heard. Due to the wide range of systems, their limitations and benefits, a specialist's advice should be obtained at an early stage of the design process to identify the most appropriate system for each location. It is possible that a combination of systems may be required to meet a range of user needs. Commonly used systems include:

1. Induction loops - can be either permanent or portable. Typically used at enquiry desks and service counters but can also be used in meeting rooms and auditorium. The potential for overspill to hearing aid users in adjoining areas needs to be considered.
2. Infrared systems - can operate through headsets or be linked to personal hearing aid devices. Ideal for use in controlled environments such as cinemas and lecture theatres and here confidentiality is important as the signal cannot be picked up outside of the source room.
3. Radio systems - useful in situations where portability is important e.g., guided tours but can also be used in an education environment where children move between classrooms and carry the equipment with them. The use of different channels can prevent overspill issues but there is still the potential for electromagnetic interference and disturbance from other radio channels.
4. Sound field systems - are beneficial to a wide range of users by providing a consistent sound level around a room regardless of distance from the source. These systems should be

linked to an induction loop, infrared, or radio hearing enhancement system, where provided.

### 7.4 Building Operations and Accessible Technologies

Where users control independent entries or exits to secured areas of facilities:

1. O&M - Should be with zero tolerance and minimum down time.
2. 25% redundancy to be considered in planning for facilities provided in building internal environments.
3. Locate controls between 900 mm to 1100 mm from the floor.
4. Mount controls at least 600 mm clear of the arc of any door swing
5. Where electronic keypads or push button systems are provided, ensure buttons are raised from the surface, mounted on a surface with high tonal contrast and have raised numerals or letters to assist users with vision loss. The electronic keypad or push button may preferably be self-illuminated for better visibility.
6. Ensure both audible and visual indicators are provided to alert users when access has been granted or denied
7. Where proximity card readers (e.g., swipe cards) are used at doors equipped with power door operators, ensure activation of both systems is synchronized
8. Provide high tonal contrast on system controls, compared to the mounting surface.
9. The electronic keypad / push button may preferably be self illuminated for better visibility.





**Image 7.6** Retrofitted ramp as an accessible entrance of a guest house  
*Photo Credits: Dr. Gaurav Raheja*

## **7.5 Retrofitting**

After a comprehensive accessibility assessment and evaluation conducted through proper access audits, it is important to develop a retrofitting plan for the building to initiate accessibility provisions within the said built form. Retrofitting planning shall be done through realistic assessments in the context of physical materiality, assistive technologies and diversity of users to be accommodated. The extent of retrofitting should not be carried out as an approach of minimum compliance but to achieve maximum accessibility and establishing

benchmarks of best practices.

It is also important to create documentation of retrofitting for accessibility, so as to initiate a good practice of accessibility mapping in building systems.

Accessible or Assistive technologies shall be explored as alternatives for various retrofitting solutions. It would always be wiser to incorporate adaptive systems to enable various aspects of building functions for wide ranging diversity including persons with disabilities. Example, installation of stair lifts at entrances of various buildings or platform lifts for stages in auditoriums or retrofitting large scale built environments like urban public spaces, river fronts,





**Image 7.7**      **Retrofitted accessible entrance through ramps in a heritage building**  
*Photo Credits: Dr. Gaurav Raheja*

street infrastructure, etc. too require a structured access audit followed by retrofitting design proposals before site implementation of universal accessibility interventions.

All new building projects must consider this perspective seriously by integrating accessibility as an integral component to their environments in order to avoid an early stage retrofitting.

Developing a reserved parking slot for persons with disabilities, installation of a ramp adjacent to existing steps, installation of lifts in old buildings, integration of mobility sensor based

lighting in building interiors, installation of tactile guiding strips, changing colour contrasts of surfaces, etc. could be wide ranging examples of retrofitting in different types of built environments.

In case structural safety or technical constraints do not allow the option of retrofitting, the built environment ownership shall have to deliver accessible services to users with special needs, if they are not able to access the regular functions.

Ultimately, as an outcome of integrating universal accessibility features in building management and operations, it should be ensured that no person with or without

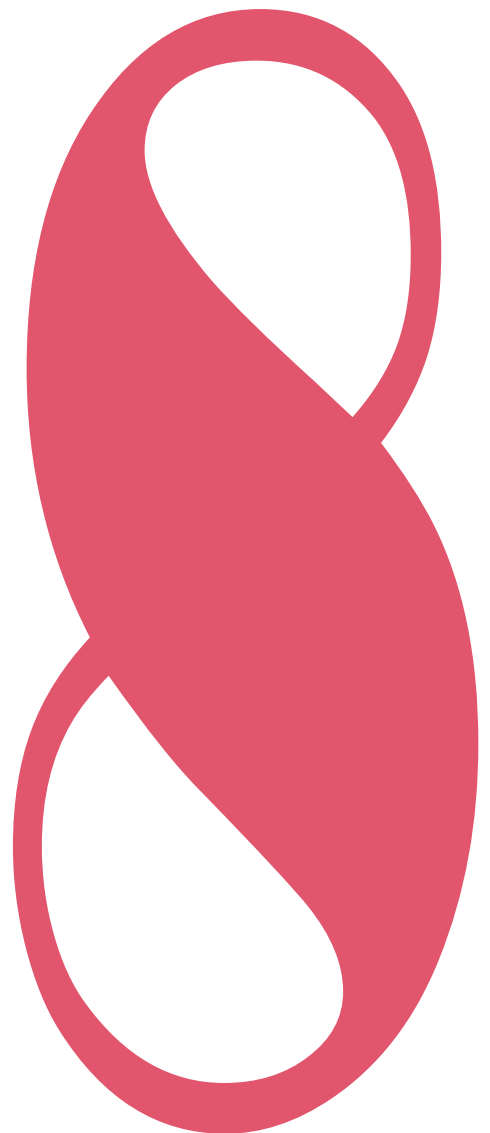


AUDIT



# Evaluating Accessibility

- 8.1 Access Audits
- 8.2 Accessibility Rating  
Mechanism
- 8.3 Developing Accessibility  
Report
- 8.4 Accessibility Checklists





*First life, then spaces, then buildings – the other way round never works.*

*-Jan Gehl*



# EVALUATING ACCESSIBILITY

# 8

All built environments should be assessed and evaluated for accessibility in three broad domains viz. Information Systems, Infrastructure systems and Building Management Systems. Assessment and evaluation becomes integral to the holistic approach of accessibility in built environments. The overall purpose of evaluation is to identify barriers to accessibility or gaps in services, based on which a retrofitting strategy and action plan could be developed for the built infrastructures.

It is suggested that the Public Buildings/ Housings, Urban Mobility and Urban Infrastructure be designed to accommodate Persons with disability empathetically, serviced with appropriately designed facilities with the emphasis on inclusion and safety at all levels. Protocols for O&M to avoid discomfort to the user. Private Players may be included as part of the campaign as part of the CSR. Initiatives and incentives campaign, enabling such partners to contribute towards a National Cause and Public Interest.

It is desirable to provide a framework for Retrofitting of existing buildings/urban Infrastructure and clear guidelines for brownfield and greenfield interventions on the basis of ground realities. However, the designers and planners have provided innovative solutions to resolve issues/

problems with a user centric approach and people first policy. Participatory Planning and inclusion through Local Area Plans should be encouraged. Pre NOC/NOC of new Buildings and Audit of Existing Buildings should be made mandatory within specified timelines. Accessibility Rating can be a useful tool for the effective Implementation of Guidelines.

## 8.1 Access Audits

Accessibility assessments must be carried out periodically. Access audit is not an exercise to merely critique the presence of barriers in the built environment but to develop strategies, ways to remove those barriers and provide reasonable accommodations. Accessibility audits are a professional activity and exercise that must be carried out at diverse scales of built environments. For the purpose of ease in understanding and practicality, it is however recommended to orient built environment stakeholders, administrators, architects & planners along with wide ranging user groups to develop conscious methods for accessibility.

Depending upon the scale of the built environment, the complexity of barriers and stakeholders sensitisation,

## Chapter 8: Evaluating Accessibility

access audits could be carried out with a strategic approach. It is largely assumed that access audits must be carried out for existing buildings, it is also highly recommended to conduct accessibility reviews during the different conceptualisation and implementation stages of new building projects.

The following broad steps are recommended for the process of conducting a holistic access audit.

### Step 1

Stakeholder meeting with Access Audit Team to define the scope of work

### Step 2

Sharing of architectural drawings alongwith visual images of the built environment

### Step 3

Reconnaissance Survey of Built Environment by the Access Audit Team

### Step 4

Detailed Access Audit on site alongwith Stakeholder Participation

### Step 5

Access Audit Highlights and Discussions with Stakeholders






### Step 6

Development of Accessibility Strategy for Retrofitting and Inclusion

### Step 7

Access Audit Report Completion and Submission

Table 8.1 Accessibility Rating Scale [ARS] ©  
Source Copyright: Dr. Gaurav Raheja, IIT Roorkee

ACCESSIBILITY ASSESSMENT	RATING SCALE	VISUAL REPRESENTATION
Hazardous, inaccessible and unsatisfactory	1	
Inaccessible and unsatisfactory	2	
Accessible and unsatisfactory	3	
Accessible and Acceptable	4	
Acceptable as best practice	5	



## 8.2 Accessibility Rating Mechanism

It is vital to understand that the key aim of an Access Audit Exercise should also take into account the stakeholder's view points. Only inputs from both perspectives can result in a sustainable evolutionary process of creating accessible buildings, environments and systems. Knowing well that diverse access audit teams and stakeholder groups lead to a varied interpretation of accessibility audits, an objective evaluation system is being proposed below to build uniformity in the whole process. Within a building system, Access Audits must be carried out at Three Levels, viz. Site and open areas level, building and built space levels and at detailed and interior levels.

For ease in implementation, understanding of the report and prioritization, it is proposed to develop a summary sheet using the following five (5) Point rating system, Accessibility Rating Scale© for evaluating each element in all three perspectives.

Towards the end of an Access Audit Exercise, we can make a compilation of which elements and spaces need to be made accessible at the highest priority. This tool can be employed in raising the overall priority of the project, as well as focusing on other priorities of retrofitting within an element as well. Example, In a building, an access audit may reveal major retrofit at the entrance itself as a high priority. However, to provide access, it may also be helpful to prioritize whether alternative flooring, provision of ramp, grab rail or any other access alternative as per requirement. The icons used through this tool could be mapped on drawings as well as visually convey the overall highlights of the access audit with clarity.

Moreover, there is also a need to bring

standardisation in the evaluation process itself because of subjectivity and based on specific needs at the venue, there could be different evaluation ratings for the same element of infrastructure in two separate audits, it is essential to have a common understanding of which are highest priority areas for ensuring basic accessibility in each set up.

This would facilitate the auditor in providing evaluation ratings and bring in a certain degree of homogeneity in accessibility across different built environments.

## 8.3 Developing Accessibility Report

A report is the main deliverable of an accessibility audit. All the observations, measurements, sketches and photographs taken during the audit would be used in developing a comprehensive report covering all parts of the public building audited, including both the external and the internal environment. It may be valuable to get feedback of employees and visitors with disabilities with respect to the building and the service provided within the building. The report is what the building owners would use to improve accessibility of their premises. Therefore, it is important that it is clear, easy to understand and based on some accessibility guidelines.

Typically, an accessibility audit report may be divided in the following:

### 8.3.1 Introduction

The introduction may cover a brief about the building audited in terms of building type and its use. Dates of the audit and the names of the members of the audit team involved including the name and

designation of the accompanying officer. Additionally, it may also specify the methodology used to undertake the audit. Apart from these, a general overview of the report may be provided with details of how the report is structured and an overview of the report may be provided. Apart from this basic information, one may optionally provide some ideas on the implementation plan for the recommendations and may develop a rating for (a suggested rating is provided in this document).

### 8.3.2 Audit Report

This is the main section of the report. This section may be divided in three parts - external environment, internal environment and information and communication and other recommendations. It may be wise to address each part of the building in a sequential manner. For instance, in the external environment one may cover elements as listed in Chapter 3. However, there can always be specific elements for diverse building typologies as well.

1. Access route from the campus gate to the building entrance
2. External pathways
3. Parking
4. Outdoor facilities, if any

In the internal environments section, one may cover elements as listed in Chapter 4 responding to the context of built environment:

1. Building entrance
2. Reception and lobby areas
3. Horizontal circulations (corridors, doors)
4. Vertical circulation (stairs, elevator, ramp, escalator)

5. Building facilities (work place, customer counters, ATM, water facilities, cafeteria etc.)
6. Signage and wayfinding systems
7. Sanitary facilities (toilets, shower areas)
8. Emergency Evacuation

In the section on information and communication, it is expected to include:

1. Information systems relating to the building
2. Information relating to the service provided in the building
3. Communication happening in the building (reception, announcements etc).
4. Communication relating to the service provided in that building
5. Sensitization on security staff, service staff, team members etc.
6. Details on assistive devices such a wheelchairs, induction loops etc. that may be important for the building owner or the service provider to have, in order to improve accessibility.

For each area, one must clearly identify and write about the barriers. Supplementing the text with a photograph, highlighting the barrier may make it easier for the reader to understand. It is equally important to identify what are the areas that complement accessibility. Disabled Friendly areas are important to identify to let the building owner know what works and also so that in the future, they can retain that design element.

For each barrier identified, one needs to provide recommendations based on the accessibility guidelines. It must be noted that while doing retrofitting into an existing building, there may be instances where providing accessibility may not be

possible. In such instances there may be a need to recommend alternate solutions. For example, in the case of a bank located on the first floor in a crowded commercial area without a lift, the only way it can become accessible is for the bank to shift to a more accessible area. While this may be a long term solution, the short term recommendation would be for the bank authorities to have a specific procedure on how they would ensure that people who are unable to visit the bank are serviced.

Annexure - This section of the report may have the technical specifications for the recommendations made. There can be a reference made to this section in the audit report section. The technical specifications provided must be based on the accessibility guidelines. Illustrations or good photographs of the technical specification being described may be very useful and will make it easier to understand.

## 8.4 Accessibility Checklists

Depending on the context of built infrastructure to be audited for accessibility, first a comprehensive list of elements needs to be prepared. Amidst both external and internal environments, each element requires to be evaluated thoroughly for accessibility.

The accessibility checklist (Table 8.1 to 8.20) provides a broad framework for evaluation of each element for accessibility. However, it is recommended to customise or adapt these checklists to suit the built environment context. It is important to ensure the significant parameters of access evaluation while customising or adapting a checklist.

Each element could further be mapped using the Accessibility Rating Scale (copyright) to understand its level of compliance. Accessibility Checklist along with the rating scale together can guide a strategy for interventions or retrofit priority for creating accessibility.





Table 8.2 Site entrance checklist for accessibility

S. NO	SITE ENTRANCE	YES/NO/REMARKS	ACCESS EVALUATION/RECOMMENDATIONS
1.	Is the site entrance marked with legible and clear signage?		
2.	Is a site map provided with braille/tactile features at the site entrance?		
3.	Are there TGSIs from the entry point to access the site independently?		
4.	Is the counter for security gate low height for interaction with security personnel?		

Table 8.3 Parking checklist for accessibility

S. NO	PARKING	YES/NO/REMARKS	ACCESS EVALUATION/RECOMMENDATIONS
1.	Are there accessible parking facilities?		
2.	Is the number of accessible parking spaces as per Table: 3.1?		
3.	Are the designated spaces wide enough 3600 mm x 5000 mm ?		
4.	Are accessible parking spaces marked by the international symbol of accessibility?		
5.	Are accessible reserved parking spaces used by unauthorised individuals/ ones without disabilities or otherwise ?		
6.	Is there a kerb ramp leading to the pathway?		
7.	Is the drop-off area marked by signage?		
8.	Is there an accessible path of travel from the drop-off area to the main entrance?		

9.	Are there Accessibility signage provided at a visible height range of 1500mm to 1800 mm?		
10.	Are the side and rear transfer zone provided with the accessible parking space?		
11.	Are there accessible parking space within a distance of 30 m from the accessible entrance?		

Table 8.4 Access routes checklist for accessibility

S. NO	ACCESS ROUTES	YES/NO/REMARKS	ACCESS EVALUATION/RECOMMENDATIONS
1.	Is the minimum width of walkway (one-way traffic) 1200 mm		
2.	Is the minimum width of walkway (two-way traffic) 1800 mm?		
3.	Is the gradient of the walkway provided at 1:20 or less?		
4.	For walkways greater than 60m in length, is there provision of resting spaces at every 30m?		
5.	For walkways built at sloping and undulating terrains, is there provision of hand rails on both sides of the access route?		
6.	Are the handrails provided at two levels as per section 3.11 ?		
7.	Are there TGSIs provided along the length of the walkway?		
8.	Are the level changes in the walkway highlighted with contrasting color strips or distinct material change?		
9.	In case there is a presence of manholes or other inspection chambers on the walkway, is the top cover flushed with the finished floor surface of the walkway?		

Chapter 8: Evaluating Accessibility

10.	Is the walkway well illuminated with the provision of lighting fixtures at multiple levels?		
11.	Is there provision of signage for walkways longer than 60m in length? (showing public amenities, distances, information)		
12.	In case of gratings on the access walkway, is the maximum gap in grating kept at 12mm wide?		
13.	Is the gap in gratings along the access walkway not more than 12mm wide?		
14.	Is the length of grating placed perpendicular to the dominant direction of movement?		

Table 8.5 Kerb ramps checklist for accessibility

S. NO	KERB RAMP	YES/NO/REMARKS	ACCESS EVALUATION/RECOMMENDATIONS
1.	Is the kerb ramp free of any obstruction such as signposts, traffic lights etc.?		
2.	Is TGSIs provided around the kerb ramp to make it easier to identify?		
3.	Is the gradient of the kerb ramp as specified in section 3.7?		
4.	Is the minimum width of kerb ramp 900mm?		

Table 8.6 Ramps checklist for accessibility

S. NO	RAMPS	YES/NO/REMARKS	ACCESS EVALUATION/RECOMMENDATIONS
1.	Is there a ramp at the entrance or inside close to the steps/ stairs?		
2.	Is the location of the ramp clearly identifiable?		



3.	Is the ramp gradient steeper than 1:12?		
4.	Is there a landing of at least 1500 mm x 1500mm, at 9m intervals provided?		
5.	Is the top and bottom of ramp clear of obstructions?		
6.	Is there a landing at every change in direction?		
7.	Is there landing at the top and bottom of every ramp?		
8.	Is the minimum width of the ramp 1200 mm?		
9.	Are there continuous handrails, on both sides, as specified in section 3.10, 3.11 and 4.6?		
10.	Is the surface of the ramp non-slip?		
11.	Is there an edge protection on both sides of the ramp?		
12.	Does it have TGSIs at the beginning and end?		
13.	Does the handrail has Braille inscriptions?		

Table 8.7 Main entrance checklist for accessibility

S. NO	MAIN ENTRANCE	YES/NO/REMARKS	ACCESS EVALUATION/RECOMMENDATIONS
1.	Is the main entrance of the building accessible?		
2.	Are there any steps at the entrance?		
3.	Do the steps have a handrail?		
4.	Are there handrails on both sides?		
5.	Is there a ramp to the entrance?		
6.	Does the ramp have a railing?		
7.	Are there handrails on both sides?		

8.	Is the clear door width at least 900 mm minimum?		
9.	Can the entrance door be operated independently?		
10.	Is the height of the door handle between 800 mm and 1100 mm?		
11.	Does the accessible entrance permit access to an elevator?		
12.	Is the accessible entrance clearly identifiable?		
13.	Is the landing surface non-slippery?		

Table 8.8 Reception and information counters checklist for accessibility

S. NO	RECEPTION & INFORMATION COUNTERS	YES/NO/REMARKS	ACCESS EVALUATION/RECOMMENDATIONS
1.	Are the counters easily indefinable?		
2.	Is there sufficient space for wheelchairs in front of the reception/ information counters?		
3.	Is the counter at two heights?		
4.	Is a part of the counter lowered to an accessible height in the range of 750 mm to 800 mm with specified knee and toe clearances?		
5.	Is a loop induction unit/ assistive technologies for hearing impaired installed at the counter?		
6.	Are there tactile pictographic maps of the building near the counter?		
7.	Is the counter well illuminated?		
8.	Is there waiting space next to the reception?		

Table 8.9 Corridors checklist for accessibility

S. NO	CORRIDORS	YES/NO/REMARKS	ACCESS EVALUATION/RECOMMENDATIONS
1.	Is the minimum unobstructed width of corridors at least 1200 mm?		
2.	Does the corridor width allow manoeuvring through doors located along its length?		
3.	Are differences in level, bridged by ramps or lifts?		
4.	Can a person with vision impairment detect all protruding objects within the corridor with a cane?		
5.	Are all over hanging obstructions mounted above a minimum height of 2200mm?		
6.	Can a person with low vision, identify and negotiate all level changes/ directional changes or other barriers in the corridor?		

Table 8.10 Doors checklist for accessibility

S. NO	DOORS	YES/NO/REMARKS	ACCESS EVALUATION/RECOMMENDATIONS
1.	Are there doors automated or assisted at the entrance?		
2.	Can the doors be operated without much effort?		
3.	Do automatic doors have sufficient long opening intervals?		
4.	Are push buttons for automatic doors located at a maximum height of 1000 mm?		
5.	Is there sufficient space beside the latch side of the doors (450-600mm)?		



Chapter 8: Evaluating Accessibility

6.	Are accessible doors placed adjacent to the revolving doors and turnstiles?		
7.	Are glazed doors marked with a colour band at eye level?		
8.	For double leaf doors, is the clear width of one of the leaves at least 900 mm?		
9.	Do doors fitted with spring closers have an extra pull handle?		
10.	Are manual door accessories /hardware (handle, lock pull etc.) as specified in section 4.10?		

Table 8.11 Lifts checklist for accessibility

S. NO	LIFTS	YES/NO/REMARKS	ACCESS EVALUATION/RECOMMENDATIONS
1.	Is there an accessible path leading to the elevator?		
2.	Is the clear door opening width 900mm or more?		
3.	Are the minimum internal dimensions of the elevator 1900 mm x 1900 mm minimum or having 13 persons capacity?		
4.	Is the height of the call button (outside the lift) between 900 mm - 1200mm, from the floor level?		
5.	Is the control panel placed at a height between 900 mm - 1200mm, from the floor level?		
6.	Are there handrails mounted at a height between 800 mm- 900 mm, from the floor level?		
7.	Is there an audio and video system installed in the lift indicating arrival at a floor?		
8.	Are there Braille/raised numbers on the control panel, with color contrast on buttons?		

9.	Is there provision of mirror on opposite side of lift door,		
10.	Is the elevator provided with a handrail on the three sides?		
11.	Are the handrails mounted at a height between 800 mm - 900mm?		
12.	Is the elevator door easy to identify?		
13.	Is the emergency intercom provided inside the elevator?		
14.	Are there tactile or Braille instructions for the communication system?		
15.	Is the emergency intercom usable without voice communication?		
16.	Is the door opening/closing interval long enough?		
17.	Is the finish of the elevator floor skid-resistant?		

Table 8.12 Staircase checklist for accessibility

S. NO	STAIRCASE	YES/NO/REMARKS	ACCESS EVALUATION/RECOMMENDATIONS
1.	Is the minimum width of the stairs 1500mm?		
2.	Are there continuous handrails, on both sides, at a height as per section 4.5?		
3.	For the staircase, more than 3000 mm wide, are there handrails installed in the centre ?		
4.	Is there provision of ramp or lift as an alternative?		
5.	Is the landing length equal to the clear width to the stairs ?		

6.	Are the step edges of a different colour or texture easily identifiable by low-vision & vision impaired persons?		
7.	Are there warning blocks installed at the beginning and end of all flights?		
8.	Is the location of emergency (fire escape) stairs clearly identifiable?		
9.	Are the height of the risers maximum of 150 mm & treads a minimum of 300 mm?		
10.	Is there presence of intermediate handrail for stairs larger than 2400 mm?		
11.	Do treads have a non-slip surface?		
12.	Do the staircase steps have open risers?		
13.	Any curved/spiral staircase used for public access?		

Table 8.13 Handrails checklist for accessibility

S. NO	HANDRAILS	YES/NO/REMARKS	ACCESS EVALUATION/RECOMMENDATIONS
1.	Are handrails mounted at a height as specified in section 3.11?		
2.	Are handrails easy to grip?		
3.	Are handrails securely attached?		
4.	Do handrails extend horizontally 300 mm at the top and bottom of every staircase or ramp?		
5.	Are the endings of the handrails grouted in the ground or turned downwards?		
6.	Is the space between the handrails and the wall as specified in section 3.11?		



7.	Are the handrails painted in contrast colours to be easily indefinable?		
8.	Are there tactile strip/ Braille plates identifications on the handrails for emergency stairs & floor levels?		

Table 8.14 Sanitary Provisions checklist for accessibility

S. NO	SANITARY PROVISION	YES/NO/REMARKS	ACCESS EVALUATION/RECOMMENDATIONS
1.	Are there accessible toilets for all including persons with disabilities, women, transgender and other diverse user groups as specified in section 4.9?		
2.	Are the toilets easily identifiable?		
3.	Is there sufficient space of 2000mm x 2200mm inside the toilets to manoeuvre a wheelchair?		
4.	Are various features in the sanitary provisions as per table 4.1, in section 4.9?		
5.	Are water closet (WC) and bidets mounted at a height between 450mm - 480mm?		
6.	Is the space between the WC and the closest adjacent wall, fitted with a grab bar, between 450 mm - 500mm?		
7.	Is the accessible washbasin mounted at a height between 750mm - 850mm?		
8.	Is the lower edge of the mirror positioned at a height not exceeding 1m?		
9.	Are the accessible showers provided with a folding seat?		
10.	Are the grab bars installed near WC and showers at a height between 750 - 850 mm?		

Chapter 8: Evaluating Accessibility

11.	Do grab bars have a diameter of 38 mm?		
12.	Do wall mounted grab bars have knuckle space 50 mm?		
13.	Are grab bars non-slip?		
14.	Can the grab bars withstand the load of 200kg minimum?		
15.	Are faucets easy to grip and operate with one hand?		
16.	Are shower fixtures with at least 1500 mm long hoses?		
17.	Are hot water pipes insulated or covered?		
18.	Is the toilet equipped with an emergency alarm system?		
19.	Can doors be locked from inside and releasable from outside under emergency situations?		
20.	Are flushing arrangements, dispensers and toilet paper mounted between 300mm and 800mm?		
21.	Is flushing equipment easy to operate?		
22.	Is the floor material skid proof, well drained and waterproof?		
23.	Do washroom doors open inward/ outwards/ both ways?		

Table 8.15 Drinking Water checklist for accessibility

S. NO	DRINKING WATER	YES/NO/REMARKS	ACCESS EVALUATION/RECOMMENDATIONS
1.	Is the drinking water space clearly identifiable by diverse user groups?		
2.	Is the Water tap/ spout accessible?		

3.	Can it be easily manoeuvred by a person with poor hand function/ wheelchair user?		
4.	Is the drinking water area dry and hygienic?		
5.	Are glasses/ water filling stations provided?		
6.	Is the drinking water facility provided as per dimensions specified section 4.8?		

Table 8.16 Outdoor eating outlet checklist for accessibility

S. NO	CANTEEN	YES/NO/REMARKS	ACCESS EVALUATION/RECOMMENDATIONS
1.	Is the eating outlet accessible for diverse user groups including persons with disabilities?		
2.	Is there a circulation path of at least 900 mm wide to allow a wheelchair user to move around the eating outlet?		
3.	Are the service counter height below 800mm?		
4.	Is the table accessible as per dimensions specified in section 4.13?		
5.	Does the table with fixed stools have accessible spaces for wheelchairs/ baby prams etc.?		
6.	Are the doorways to the eating facilities accessible ?		

S. NO	SIGNAGE	YES/NO/REMARKS	ACCESS EVALUATION/RECOMMENDATIONS
1.	Are accessible spaces identified by the international symbol of accessibility?		
2.	Are there directional signs indicating the location of accessible facilities?		



Chapter 8: Evaluating Accessibility

3.	Are maps, information panels and wall-mounted signs placed at a height between 900mm and 1800mm?		
4.	Are signs clear, simple and easy to read?		
5.	Is the colour of signs clearly distinguishable?		
6.	Is the surface of the sign processed so as to prevent glare?		
7.	Is the sign supplemented by a text in embossed letters or in Braille available next to information signs?		
8.	Is the lettering size proportional to the reading distance?		
9.	Is the signage provided in bilingual/trilingual formats?		
10	Does the signage have appropriate pictograms for ease in identification/navigation ?		

Table 8.18 Emergency evacuation checklist for accessibility

S. NO	EMERGENCY EXITS	YES/NO/REMARKS	ACCESS EVALUATION/RECOMMENDATIONS
1.	Are emergency exits clearly marked with directional arrow signs?		
2.	Does the emergency exit lead to the accessible assembly areas?		
3.	Are the emergency exits as specified in section 7.3?		

Table 8.19 Public telephones checklist for accessibility

S. NO	PUBLIC TELEPHONES	YES/NO/REMARKS	ACCESS EVALUATION/RECOMMENDATIONS
1.	Are there public telephones accessible to wheelchair users?		
2.	Is there at least one telephone in the building equipped with a loop induction unit?		
3.	Are the numerals on the telephone raised to allow identification by touch?		
4.	Is there proper signage directing to the public telephone?		
5.	Are the heights of the operable parts of the telephone between 800mm and 1000 mm?		
6.	Is there a clear maneuvering space?		
7.	Are there provision of egress route map, emergency alarms (visual & audio)?		

Table 8.20 Resting facilities checklist for accessibility

S. NO	RESTING FACILITIES	YES/NO/REMARKS	ACCESS EVALUATION/RECOMMENDATIONS
1.	Where there are large spaces, are resting facilities provided at 30 meters of intervals?		
2.	Is there an adjoining space for a wheelchair next to benches and public seats?		
3.	Are public seats with height of 450mm - 500mm?		
4.	Are there backrest, arm rest and seating for children?		

IN CASE OF EMERGENCY  
PUSH RED BUTTON  
TO OPEN DOOR

No Smoking

કચ્છાને વાકાઈ  
જુલે સમીને સમીને  
જીવન સુધારે ને જુલે જીવન  
PLEASE STAY AWAY  
FROM THE DOOR

121

સારથી બંગલોડ SARTHI BUNGALOWS



FIRE EXTINGUISHER

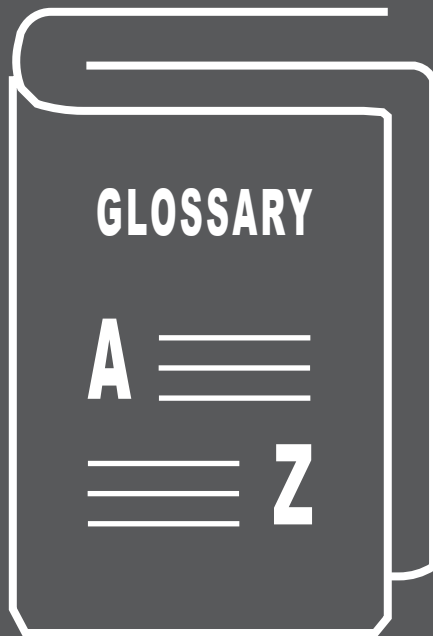




*In line with the year's @UN theme of 'Building Back Better: towards a disability- inclusive, accessible and sustainable post COVID - 19 World', let us collectively keep working towards ensuring opportunity and improving accessibility for Divyaang sisters and brothers.*

**Shri Narendra Modi  
Prime Minister, India**

Twitter Post by @narendramodi, 3 Dec 2020,  
Address on International Day of Persons with Disabilities








*Cities have the capacity of providing something for everybody, only because, and only when, They are created by everybody.*

*-Jane Jacobs*

zug  
e



# GHOST

DAS MUSICAL

Städt. Theater des Westens Berlin - westend.de - 0 30 85 7 04 00

Theaterkasse nur 30 Meter von hier!

Städt.

## HOTEL

100 m Hardenbergstraße 21

+49 (0)30 233 214 100  
[www.aletto.de](http://www.aletto.de)



### aletto

HOTEL KUDAMM

17 m Single-Zimmer 49€  
22 m Double-Zimmer 59€



24h-Rezeption auch nachts  
WLAN kostenlos (Free WiFi)  
Lagerplätze gratis

# APPENDICES

# 9

## Appendix 1: References

1. Architectural Services Department - Hong Kong. (2012). Universal Accessibility Best Practices and Guidelines. 1-150.
2. Building and Construction Authority - Singapore. (2019). Code on Accessibility in the Built Environment 2019. 1-264.
3. Building and Construction Authority - Singapore. (2016). Universal Design Guide for Public Places. 1-103.
4. Bureau of Indian Standards. (2016). National Building Code of India, 2016 Volume 1. 1-1226.
5. Centre for Excellence in Universal Design. (2012). Building for everyone: A universal design approach, external environment and approach. 1-110.
6. Centre for Excellence in Universal Design. National Disability Authority, Ireland (2012). Building for everyone: A universal design approach, entrances and horizontal circulation. 1-88.
7. Centre for Excellence in Universal Design. (2012). Building for everyone: A universal design approach, vertical circulation. 1-84.
8. Centre for Excellence in Universal Design. (2012). Building for everyone: A universal design approach, internal environment and services. 1-100.
9. Centre for Excellence in Universal Design. (2012). Building for everyone: A universal design approach, sanitary facilities. 1-122.
10. Centre for Excellence in Universal Design. (2012). Building for everyone: A universal design

## Chapter 9: Appendix

approach, facilities in buildings. 1-70.

11.Centre for Excellence in Universal Design. (2012). Building for everyone: A universal design approach,building types. 1-160.

12.Centre for Excellence in Universal Design. (2012). Building for everyone: A universal design approach,building management. 1-70.

13.Centre for Excellence in Universal Design. (2012). Building for everyone: A universal design approach, planning and policy. 1-96.

14.City of Ottawa. (2015). Accessibility Design Standards – Ottawa. November, 1-274.

15.City of Toronto. (2004). City of Toronto accessibility design guidelines. 1-137.

16.Department of Justice - USA. (2010). 2010 ADA Standards for Accessible Design.1-279.

17.Dubai Creative Clusters Authority. (2016). Accessibility Code For The Built Environment. 1-68

18.Government of Dubai. (2017) Dubai Universal Design Code. 1-330.

19.Khare. R., Mullick. A., Raheja. G.,Universal Design India Principles @ 2011; A Collaborative Process Of Developing Design Principles, 13th International Conference on 'Mobility and Transport for Elderly and Disabled Persons' TRANSED 2012, 2012

20.Ministry of Urban Development. (2016). Harmonised guidelines and space standards for barrier free built environment for persons with disability and elderly persons. 1-135.

21.Ministry of Urban Development. (2016). Model Building Bye Laws. 1-268.

22.RPWD. (2016). IV.36 Rights of Persons with Disabilities. Elgar Encyclopedia of International Economic Law, DI, 654–656.

23.PLAE, Inc, & Sea Reach, Ltd. (1993). Universal Access to Outdoor Recreation: A Design Guide. Mig Communications.

24.The Tokyo Organising Committee of the Olympic and Paralympic Games. (2017). Tokyo 2020 Accessibility Guidelines. 1-153.

25.The Centre for Accessible Environments - RIBA. (2004). Designing for Accessibility: an essential guide for public buildings. 1-76.

26.UN General Assembly. (2007). Convention on the Rights of Persons with Disabilities: Resolution adopted by the General Assembly. United Nations. 1-29.

27.United Nations. (2017). New Urban Agenda. [www.habitat3.org](http://www.habitat3.org)



## Appendix 2: Slip resistance materials

MATERIAL	SLIP-RESISTANCE		REMARKS
	DRY AND UNPOLISHED	WET	
Clay tiles (carborundum finish)	very good	very good	May be suitable for external stairs
Carpet	very good	good	-
Clay tiles (textured)	very good	good	May be suitable for external stairs
Cork tiles	very good	-	-
PVC with non-slip granules	very good	good	-
PVC	very good	poor to fair	Slip-resistance when wet may be improved if PVC is textured. Edges of sheet liable to cause tripping if not fixed firmly to base.
Rubber (sheets or tiles)	very good	very good	Not suitable near entrance doors.
Mastic asphalt	good	good	-
Concrete pavers (interlocking)	good	good	-
Vinyl tiles	good	fair	-
Linoleum	good	poor to fair	Edges of sheets may cause tripping if not securely fixed to base.
Concrete	good	poor to fair	If a textured finish or a non-slip aggregate is used, slip-resistance value when wet may be increased to good.
Granolithic	good	poor to fair	Slip-resistance when wet may be improved to good by incorporating carborundum finish.

MATERIAL	SLIP-RESISTANCE		REMARKS
	DRY AND UNPOLISHED	WET	
Cast iron	good	poor to fair	Slip-resistance may be acceptable when wet if open treads are used.
Clay tiles	good	poor to fair	Slip-resistance when wet and polished very poor.
Terrazzo	good	poor to fair	Non-slip nosing necessary on stairs. Slip-resistance when polished or if polish is transferred by shoes from adjacent surfaces very poor.
Marble/ granite	good	very good to fair	Slip-resistance when wet and polished very poor.

## Appendix 3: Glossary

**Access Aisle** - An accessible pedestrian space between elements, such as parking spaces, seating and desks that provides clearances appropriate for use of the elements.

**Accessible** - A site, building, facility, or portion thereof that complies with these Guidelines and that can be approached, entered, and used by all people.

**Accessible Route** - A continuous unobstructed path connecting all accessible elements and spaces in a building or facility that can be negotiated by a severely disabled person using a wheelchair and that is also safe for and usable by people with other disabilities. Exterior accessible routes may include parking, access aisles, kerb ramps, walkways, and ramps. Interior accessible routes may include corridors, ramps, elevators, lifts, and clear floor space in front of fixtures.

**Accessible Signage** - Any visual way finding system incorporates architecture, landscape design, lighting, landmarks, and orientation points. Signage is one key element of an effective way finding system and should be accessible to all users including people with disabilities.

**Ambulatory Disabled** - A person who is able, either with or without personal assistance, and who may depend on prostheses (artificial limbs), orthotics (calipers), sticks, crutches or walking aids to walk on level or negotiate suitably graded steps provided that convenient handrails are available.

**Automatic Door** - A door equipped with a power operated mechanism and controls that open and close the door automatically upon receipt of a momentary signal. The switch that begins the automatic cycle may be photoelectrical device, floor mat, sensing device, or manual switch mounted on or near the door itself.

**Beveled** - Smooth, slanted angle between two surfaces; for example, a slant or inclination between two uneven surfaces to allow easier passage of a wheelchair.

**Braille Signage** - Is a specialist way finding device that incorporates Braille as a primary source of information for people who are vision impaired and maybe aided with raised tactile lettering, maps, or pictorial images.

**Braille** - The Braille system is a method that is widely used by blind people to read and write.

**Circulation Path** - An exterior or interior way of passage from one place to another for pedestrians, including walkways, hallways, courtyards, stairways, and stair landings.  
Clear - Unobstructed

**Colour Contrast** - The basic guidelines for making effective colour choices are based on the hue value of the colours. The most commonly used methods of achieving colour contrast is to incorporate either “harmonising” or “contrasting” colour combinations.



**Cross Slope** - Cross slope or camber is a geometric feature of pavement surfaces: the transverse slope with respect to the horizon. It is a very important safety factor. Cross slope is provides a drainage gradient so that water will run off the surface to a drainage system such as a street gutter or ditch.

**Disability** - is an umbrella term for impairments, activity limitations, and participation restrictions, denoting the negative aspects of the interaction between an individual (with a health condition) and that individual's contextual factors (environmental and personal factors). Disability is neither simply a biological nor a social phenomenon but arises from the relationship between health condition and context.

**Grab Bars** - A bar used to give a steadying or stabilizing assistance to a person engaged in a particular function.

**Handrails** - A rail used in circulation areas such as corridors, passageways, ramps, and stairways to assist in continuous movement.

**Hue** - Hue is the perceptual attribute associated with elementary colour names. Hue enables us to identify basic colour categories such as blue, green, yellow, red and purple. People with normal colour vision report that hues follow a natural sequence based on their similarity to one another. With most colour deficits, the ability to discriminate between colours based on hue is diminished.

**Individual Washrooms** - A compartment having the basic requirements of a water closet compartment, washbasin and other essential washroom accessories as required by people with disabilities.

**Induction loop** - An induction or inductive loop is an electromagnetic communication or detection system which uses a moving magnet to induce an electric current in a nearby wire. Induction loops are used for transmission and reception of communication signals, or for detection of metal objects in metal detectors or vehicle presence indicators. A common modern use for induction loops is to provide hearing assistance to hearing-aid users.

**International Symbol of Access** - Also known as the (International) Wheelchair Symbol, the International Symbol of Access consists of a square overlaid with a stylized image of a person using a wheelchair. The symbol is often seen where access has been improved, particularly for wheelchair users and other mobility impaired persons. The symbol denotes a barrier free environment, such as steps, to also help older people, parents with prams, and travelers with luggage. The wheelchair symbol is "International" and therefore not accompanied by Braille in any language.

**Kerb** - A side barrier to a trafficable surface or is the edge where a raised sidewalk/footpath, road median, or road shoulder meets an unraised street or other roadway.

**Kerb Ramp**- A short ramp cutting through a curb or built up to it or a Kerb is a drop, with walkway, at a gradient no greater than 1:10 on both sides of necessary and convenient crossing points. Width should not be less than 1200mm. If width (X) is less than 1200mm, then slope of the flared side shall not exceed 1:12.

**Knurled Surface**- Roughened area, often in a crisscross pattern; used on either doorknobs

or grab bars. On doorknobs, it is used to provide tactile clues to visually impaired persons to indicate that passage leads to an area of danger. On grab bars it is used to improve grasp and to prevent slipping.

**LRV**- Light reflectance value (LRV) is the total quantity of visible light reflected by a surface at all wavelengths and directions when illuminated by a light source.

**Luminosity Contrast**- Also known as tonal contrast, it is the most important element that assists people with vision impairments to distinguish between two different surfaces. A minimum difference of 30 points in the Light Reflectance Value of colours of two architectural surfaces produces an adequate luminosity contrast that is perceivable by persons with vision impairments.

- Marking a parking space reserved for vehicles used by Persons with Disabilities
- Marking a public lavatory with facilities designed for wheelchair users

**Lux** - Is the standard unit of illumination. It is used as a measure of perceived intensity of light.

**Operable Parts** - A part of a piece of equipment or appliance used to insert or withdraw objects, or to activate, deactivate, or adjust the equipment or appliance (for example coin slot, pushbutton, handle).

**Passing places** - a space on the footpath, single track road or one lane road that permits two ways travels when it is not wide enough to allow wheelchairs/vehicles to pass one another.

**Persons with Disabilities** - A Person with Disability is a person with any physical, mental, intellectual, or sensory impairment which in interaction with various barriers may hinder full and effective participation in society on an equal basis with others. The term “Persons with Disabilities”, consistent with the terminology used in the UNCRPD, is used throughout these Guidelines.

**Public Areas** - Interior and exterior rooms or spaces that are made available to the public. Public use may be provided at a building or facility that is privately or publicly owned.

**Public Use**- Describes interior and exterior rooms or spaces that are made available to the public. Public use may be provided at a building or facility that is privately or publicly owned.

**Ramp**- An inclined way connecting one level with another.

**Signage**- Any room number, name tag, building directory, or similar object containing a printed message and/or symbol. Signage and signs are used synonymously in this document.

**Space**- A definable area (for example, toilet room, hall, assembly area, entrance, storage, room alcove, courtyard, or lobby).

**Tabletop** - Road raised to footpath/footway level at crossing or with leveled.

**Tactile** - Tactile means information and interpretations derived from the sense of touch. This involves sensory transfer through physical contact of the hands or feet with other surfaces, as well as sensory transfers received by contact with non-physical elements such as pressure, wind, and temperature.

**Tactile Ground Surface Indicators** - Also known as Tactile paving/tiles, provide a distinctive surface pattern of “strips” and “truncated domes” or cones (which are small domes or cones that have had their tops cut off, or truncated) detectable by long cane or underfoot which are used to guide/alert persons with vision impairments of their approach to facilities, streets, and hazardous drop-offs. People who are blind or visually impaired are alerted of impending danger from vehicle impact or a grade change.

**Tactile signs (Refer also to Braille Signage)** -Tactile signage incorporates raised text or symbols to enable touch reading by people who are blind, and touch enhancement of visual perception for people who are vision impaired.

**Tactile Guiding Blocks** - These are 300 x 300 mm tiles that incorporate bars that are 5mm ( $\pm 0.5$ mm) high, 20mm wide and spaced 50mm from the centre of one bar to the centre of the next. These flat-topped bars that are easily detectable underfoot by people with visual impairments. They are used externally to guide people with visual impairments along the circulation path. They may also be used internally in large busy areas such as railway stations and airports.

**Tactile Warning Blocks** - To warn persons with visual impairments of the approaching danger, it is recommended to incorporate Tactile Ground Surface Indicators (TGSIs) along the approach path to unavoidable obstacles and hazards. TGSIs, also commonly known as, Tactile Warning Blocks, are 300 mm x 300 mm tiles that incorporate rows of 5 mm ( $\pm 0.5$  mm) high flat-topped blister like domes that are easily detectable underfoot by persons with visual impairments. These tactile warning blocks are recognized internationally as a sign of approaching hazards.

**Traffic island** - can be a median strip, a strip in the middle of a road. It can also be a narrow strip between roads that intersect at an acute angle. Some traffic islands may serve as refuge islands for pedestrians.

**Universal Design** - Defined as “the design of products and environments to be usable by all people, to the greatest extent possible, without the need for adaptation or specialized design”.

**Vision impairment** - Vision impairment is any significant loss of sight.

**Water Closet Compartment/Toilet Cubicle** - A compartment having a water closet with grab bars installed to assist people with physical disabilities

**Wheelchair User** - A person who depends on a wheelchair for mobility

**White Cane** - A white cane is a long rod-like device used by blind or visually impaired travelers to give them information about the environment they are traveling through.













A.M.T.S.  
BUS STOP

HOTEL  
CHANDRA  
PALACE

ASHOK LEYLAND

GJ01  
HT2985



2021  
Harmonised Guidelines & Standards for Universal Accessibility in India



Harmonised Guidelines & Standards  
for Universal Accessibility in India  
2021



  
Ministry of Housing  
and Urban Affairs  
Government of India

  
Ministry of Housing and Urban Affairs  
Government of India

Nine colours

Nine waves

waves with distinct  
curved profiles

Nine icons

## Cover Design Concept

### **Waves of Diversity and Pluralism**

The graphic composition represents nine waves, nine colours and nine icons representing diversity and pluralism as a foundation of universally accessible and inclusive India.

The waves with distinct curved profiles represent a human life span with ability and disability as an inclusive experience for all.

The nine icons representing the diversity of age, gender and abilities provide a framework for including all. Semantically, the number 'nine' also represents the cosmic universe in Indian mythology.

The cover design reinforces a positive image of inclusion with diversity and dignity to all human lives. It celebrates the idea of difference amidst the pursuit of equity.

2021

# Harmonised Guidelines & Standards for Universal Accessibility in India



भारत सरकार

Ministry of Housing  
and Urban Affairs  
Government of India