

Street Design Guidelines

“...for Equitable Distribution of Road Space” - NUTP

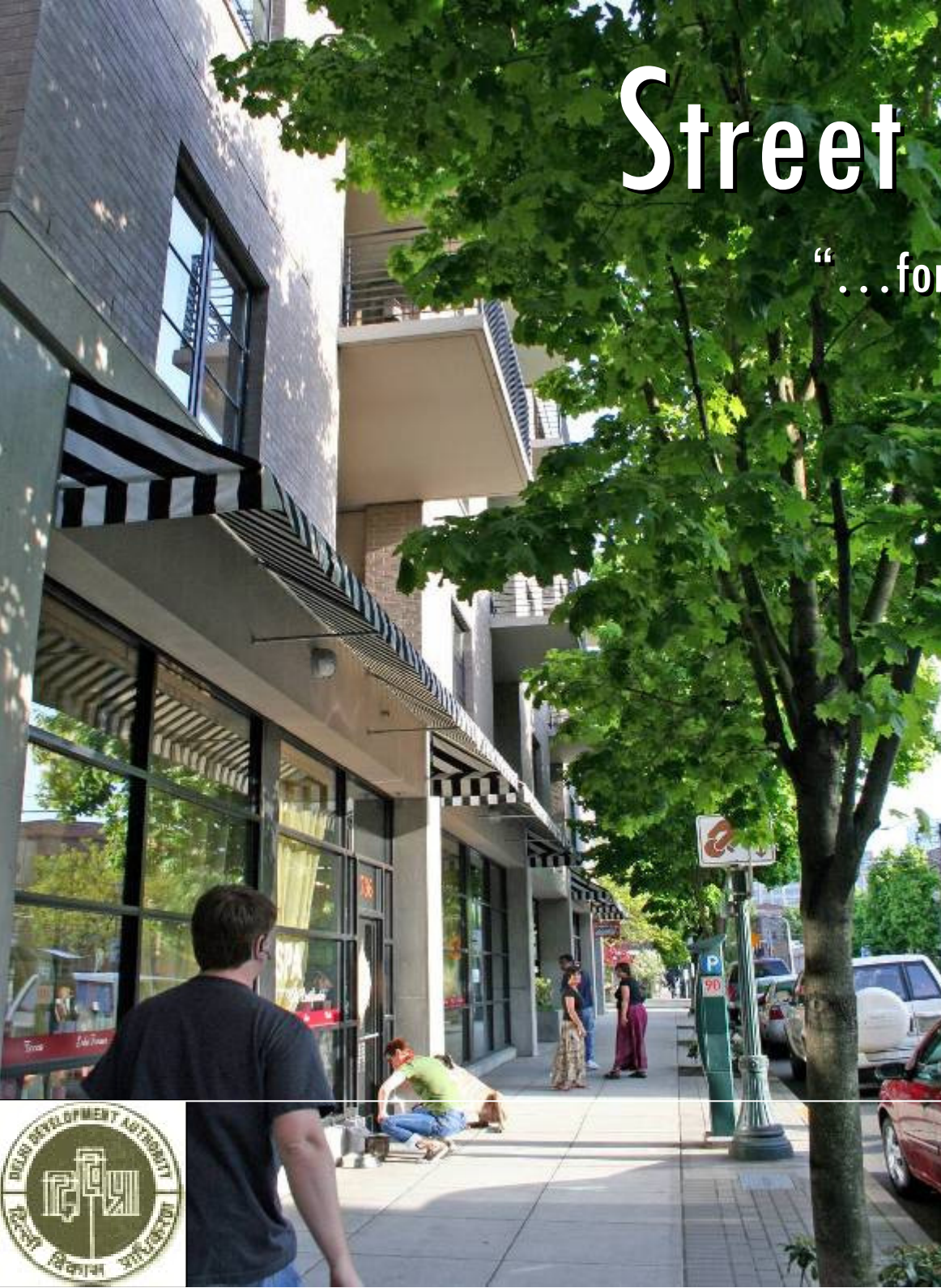

© UTTIPEC, Delhi Development Authority, New Delhi
Guidelines Adopted: Nov 2009. Revision 1: Nov 2010

The Governing Body of Unified Traffic and Transportation Infrastructure (Plg. & Engg.) Centre (UTTIPEC) under the Chairmanship of Sh. Tejendra Khanna, Hon'ble Lt. Governor had approved the "Pedestrian Design Guidelines" on 20.11.09 as per the recommendation of the Working Group for immediate implementation, enforcement and uniform adoption by all the road owning agencies.

After 6 months a review of the Pedestrian Design Guidelines was initiated and discussed in the Working Group - I A meetings held on 23.6.10, 23.7.10, 17.8.10 and 19.11.10. It was suggested that "Pedestrian Design Guidelines" to be renamed as "Street Design Guidelines" after incorporating the suggestions of the Working Group.

The Governing Body approved the final revised "Street Design Guidelines" in its 27th meeting held on 25.11.10 under the Chairmanship of Sh. Tejendra Khanna, Hon'ble Lt. Governor, as per the recommendation of the Working Group - I A meeting dated 19.11.10.

Acknowledgements

The preparation of Draft Pedestrian Design Guidelines was initiated after a detailed presentation on “Great Pavements for Delhi” was made by Sr. Consultant, UTTIPEC in the Governing Body meeting on 24.4.2009. The presentation was appreciated and road owning agencies were requested to adopt some of the best practices on pilot project basis. As a follow up, these set of guidelines were put together, based on best practices available around the world and customized to ground conditions and challenges in India, particularly in Delhi. In this, the UTTIPEC Core team was helped immensely by the advise, time and material provided by several experienced and respected experts in the field, mentioned below:

- Sachdeva, Pradeep, Architect, Pradeep Sachdeva Design Associates
- Gandhi, S., Arora, A., Varma, R., Sheth, Y., Sharma, S., Jawed, F., Interface for Cycling Expertise (ICE), Manual for Cycling Inclusive Urban Infrastructure Design in the Indian Subcontinent, 2009
- Aggarwal, Anjlee, Executive Director, Samarthayam, Guidelines for Inclusive Pedestrian Facilities, Report for IRC, 2009
- Transport Research And Injury Prevention Programme (TRIPP), IIT Delhi, BRT Design Specifications, 2009
- Choudhury, Anumita R., Associate Director, Centre for Science and Environment, Footfalls: Obstacle Course to Livable Cities, Right to Clean Air Campaign, 2009
- Hingorani, Akash, Oasis Designs, Inc.
- INTACH, Delhi Chapter

In due course, a review of Pedestrian Design Guidelines was initiated after 6 months of its publication to include some more chapters related with Storm Water Management, Kerb heights, Slip Roads, Bus Corridors and updates on Signalized left turn lanes, radius of turning movement of left turns, etc. and an overall review was done to incorporate various suggestions received from experts & implementing agencies.

Sh. S.N. Sahai, Chairman of WG-1A and Sh. Ashok Kumar, Commissioner (Plg.) DDA, Co- Chairman of WG-1A have given their complete support with timely advise for revision and completion of this guideline document within a particular time frame. Sh. B. K. Jain, AC (TC&B), DDA has provided necessary guidance/advise, which has helped complete the process of preparing the final document.

Several external consultants have also voluntarily helped in the preparation of drawings and sketches incorporated in the guidelines including Ms. Ran Chen, ui2 International and Mr. Nishant Lall, NilaA Architecture & Urban Design. The document was prepared and finalized by the UTTIPEC Core Team under Ms. Paromita Roy, Sr. Consultant with the assistance of in-house consultants and interns from SPA with a special mention to Mr. Sahil Sasideran, during the period from 19th May to 19th July.

All the other Sub-group members and special invitees who have attended various meetings of Working Group I-A and the Sub-group, have provided necessary inputs for formulating and finalizing the Street Design Guidelines. List of references is placed at Annexure-II. List of Working Group members, sub-group members, UTTIPEC Core Consultants team and other participants/special invitees is placed at Annexure-III.

Shri Ashok Bhattacharjee,
Director (Plg.) UTTIPEC,

VISION

The National Urban Transport Policy, Government of India states the following VISION under which UTTIPEC functions:

- To recognize that people occupy centre-stage in our cities and all plans would be for their common benefit and well being.
- To make our cities the most livable in the world and enable them to become the “engines of economic growth” that power India’s development in the 21st century.
- To allow our cities to evolve into an urban form that is best suited for the unique geography of their locations and is best placed to support the main social and economic activities that take place in the city.

The UTTIPEC propagates that Streets are valuable public spaces as well as movement corridors.

Design of Streets is a function of the Street Hierarchy and Adjacent Landuses.

A set of 10 non-negotiable Street Design Components as well as additional guidelines for world class streets — have been outlined in this document.

Contents

	VISION	4
Chapter 1	Need for Street Design Guidelines	7
Chapter 2	Existing Frameworks – NUTP, MPD-2021	13
Chapter 3	Essential Goals for Street Design	17
Chapter 4	Street Hierarchy of Delhi with Categorization by Function	25
➤	Suggestive Street Sections showing comparison with IRC Street Sections.	30
Chapter 5	Design Toolkit: Mandatory Components	38
	1. Components of the Pedestrian only Zone (including Kerb Radii and Slip Roads)	42
	2. Frontage Zone or “Dead Width”	52
	3. Universal Accessibility Features/ Barrier Free Design	55
	4. Multi-Functional Zone with Planting for Storm Water Management	63
	5. Bicycle and Non-Motorized Transport (NMT) Infrastructure	75
	6. Crossings	81
	7. Medians, Refuge Islands	87
	8. Street Lighting	91
	9. Urban Utilities	97
	10. Public Aménities (Toilets, Bus stops, Dustbins), Hawker Zones, Signage	103
Chapter 6	Design Toolkit: Additional Requirements	115
	11. Traffic Calming Measures	116
	12. Material Selection	123
	13. Public Art, Street Furniture and Educative Signage	139
	14. BRT Systems; Bus and HOV Lanes	147
Annexure I	Storm Water Management and Rain Water Harvesting in Street Right-of-Ways – Sample System Design and Calculations.	162
Annexure I	References	164
Annexure III	Working Group 1-A Members, Experts, Special Invitees and others.	165
Annexure IV	UTTIPEC Street Design Checklist – for Approval of Projects (http://uttipec.nic.in/writereaddata/mainlinkFile/File280.pdf)	167

This page is intentionally left blank.

1. Need for Street Design Guidelines



Need for Equitable Street Design



Inadequate space for pedestrians



Inadequate space for pedestrians



Inappropriate kerb heights



Missing sidewalks!



Missing sidewalks



Encroached space by trees, utilities



Inadequate Amenities.

Need and prospective Benefits of Equitable Design

Increased Pedestrian Design consideration in Streets would provide:

- **Increase in comfort** for current walking population.
- Comfortable **last mile connectivity** from MRTS Stations – therefore increased ridership of buses and Metro.
- **Reduced dependency on the car**, if shorter trips can be made comfortably by foot.
- More exercise, so **better health** for people walking.
- **Prioritization of public transport** and non-motorized private modes in street design
- Reduced car use leading to **reduced congestion and pollution**.
- **More equity** in the provision of comfortable public spaces and amenities to all sections of society.

**DOWNSIDE OF
GROWTH**

**INDIA'S POLLUTION
TIME BOMB**

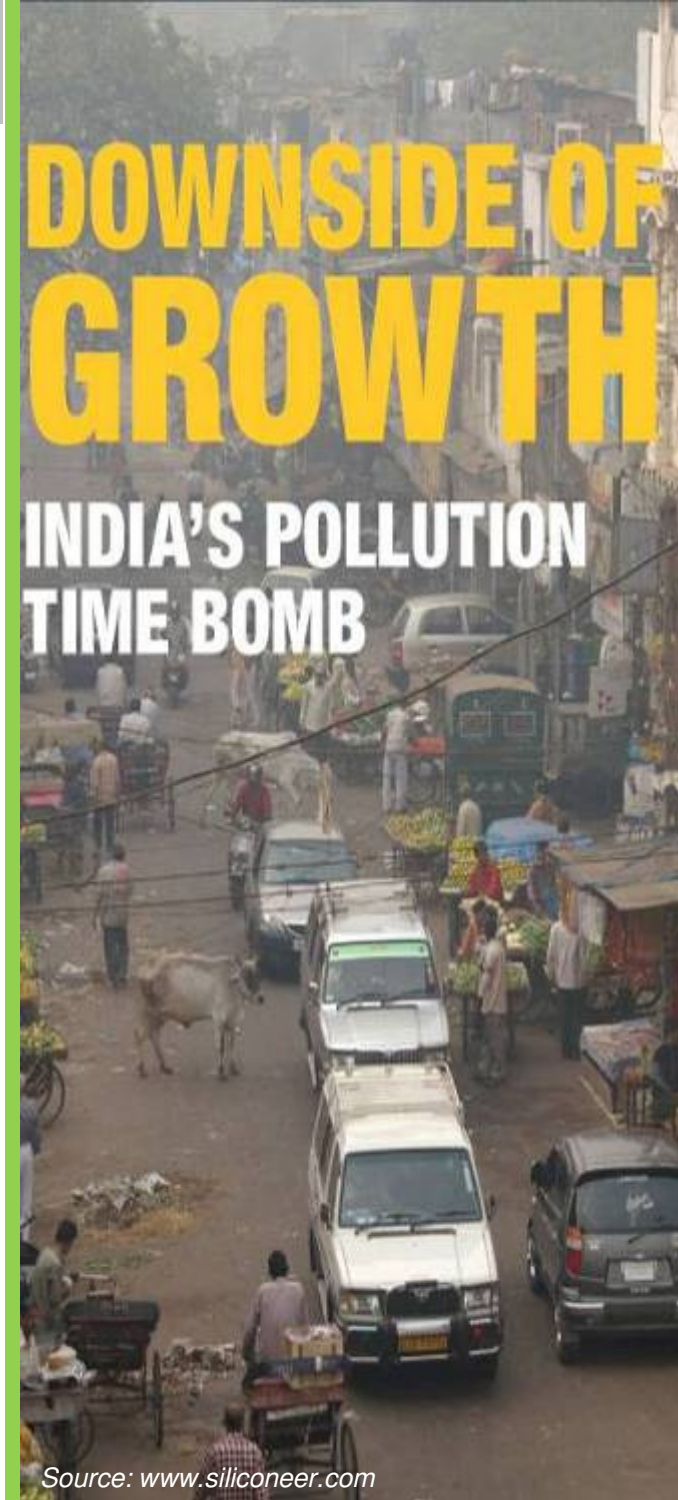

Source: www.silliconeer.com

Consequences:

Only 14% of the city drives, yet most of the road space is occupied by them.

Roads in Delhi have been primarily designed to increase the speed and ease of movement of car users.

Car-oriented design priority and discouragement of walking through inadequate design – has discouraged people from walking and in turn encouraged car-dependency.

The following are the consequences:

Delhi has more cars than the total cars in Maharashtra, Tamil Nadu, Gujarat & West Bengal.

Pollution levels in Delhi are almost double of Mumbai, a city more populated than Delhi.

Current Facts: Modal Share of Delhi

MODE	% of PERSON TRIPS		
	WITH WALK TRIPS (2007-08)		
•CAR/TAXI	9.09	23	Motorized Private Transport
•2W	14.07		
•AUTO RICKSHAW	2.36	33	Public/ Para-Transport
•BUS	27.12		
•METRO	2.66		
•TRAIN (IR)	0.42		
•BICYCLE	4.46	44	Non-motorized Public/ Private Transport
•CYCLE RICKSHAW	5.16		
•WALK	34.67		
TOTAL	100		
TOTAL TRIPS/DAY	219.87 LAKH	100	

Source: Anon 2008, Transport Demand Forecast Study: study and development of an Integrated cum Multi Modal Public Transport Network for NCT of Delhi, RITES, MVA Asia Ltd, TERI, May 2008

- **34% of the population engages in "Walk-only" trips** for their daily travels, needs or errands.
- **Only 14% population of Delhi rives private cars.**

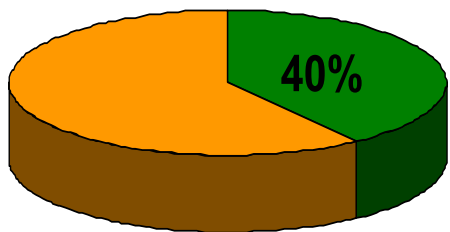

- **40% of the total Road Length of Delhi has NO Sidewalks! ***

And the ones having sidewalks, lack in quality in terms of surface, width and geometrics.*

'We may survive, our kids won't'
SAYS ENVIRONMENT minister summing up the State Environment Report India 2009

POLLUTION WATCH

***RSPM LEVELS OF 90 PER CENT INDIAN CITIES IS RISING.**

DELHI	MUMBAI	CHENNAI
2000 150 ug/m3.	80 ug/m3.	90 ug/m3.
2008 192ug/m3	110ug/m3	50 ug/m3

(Unit micrograms per cubic meter of air)

CAUSE India had **2 crore** vehicles in 1991. In 2008, **8.6 crore**

Of total cars, **17%** run in Delhi. It's more than total cars in Maharashtra, Tamil Nadu, Gujarat & West Bengal. Rising industrial pollution another cause.

*RSPM: Respirable Suspended Particulate Matter is the the small pieces of soot and dust that get inside the lungs

Why is promoting of Walking and Cycling Important?

The Data below shows that even in Cities where Public Transport availability and usage is high, the modal share of private transport is still high, due to low walking and cycling use.

Therefore promoting of walking and cycling infrastructure helps shift short trips (1 – 4 km trips which constitute 60% of all trips in Delhi) to walk or non-motorized modes, thus bringing down private car dependency.

Relationship between Private Vehicle Use and Walking & Cycling friendly City:

City	Modal share, percent		
	Car + MTW	PT	W&C
Bristol, UK	65	12	23
Leeds, UK	61	36	3
Nantes, France	58	14	28
Helsinki, Finland	54	20	26
Marseille, France	53	12	35
Edinburgh, UK	52	29	19
Newcastle, UK	48	19	33
Brussels, Belgium	44	18	38
Frankfurt, Germany	42	21	37
Stuttgart, Germany	36	25	39
Amsterdam, Neth's	32	16	52

MTW- motorized two-wheeler, PT – Public transport
W&C – Walking and cycling

Delhi, India	23	33	44
Mumbai	15	52	33
Kolkata	12	58	30
Chennai	31	39	30

India already has high mode share for Non-motorized Modes. This should therefore be encouraged and made safer through design and adequate space allocation.

Data shows that providing public transport alone is not enough to reduce car dependency.

Cities around the world which encourage walking and cycling/ non-motorized transport use are found to have lower car/ private vehicle dependency .

*Data Source: IIT Delhi, 16.08.2010;
Indian Data Source: Wilbur Smith Associates, Ministry of Urban Development, Govt. of India, 2007*

Who walks in Delhi?



Look at these black spots on the lung. The unfortunate owner lives in Delhi and has been breathing polluted air. Air full of carbon particles which accumulate in the lungs (black spots). What you can't see is a cocktail of gases and tiny particles, even smaller than carbon that get into our bodies. Actually, you are getting polluted.

Delhi lung
Capital punishment
Scary? But those cars are so sexy!

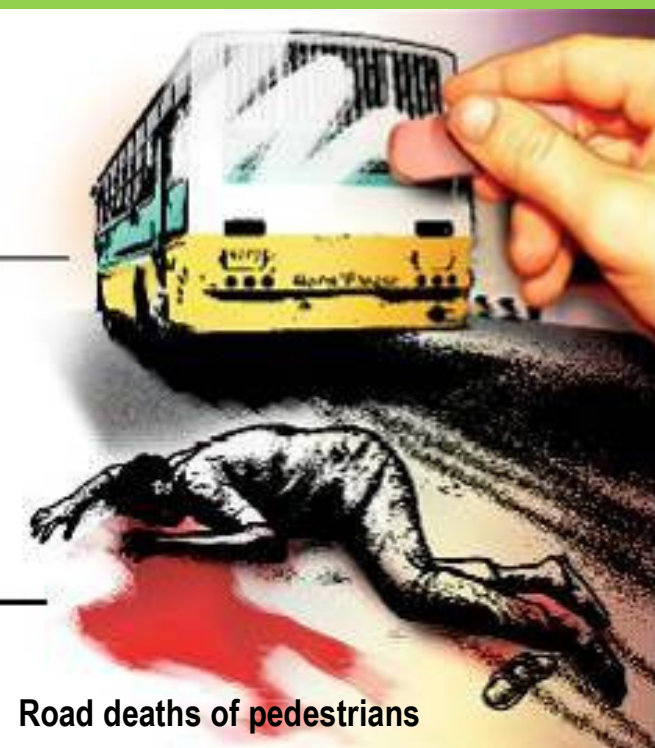

Road deaths of pedestrians

Walking for work, education and services.....

Of all education trips – 58% walk trips
Service and business trips – 31% walk trips (RITES 2001)

Walking and urban poor.....

About 60% of people live in low income localities. An earlier estimate shows 22% of people with less than Rs 2000/month income walk in Delhi. Moving slums out to periphery had sharply reduced women employment as accessibility became a problem

Disability and walking.....

Samarthyam survey: 58% of the disabled found steps, ramps, difficult to negotiate; 45% of elderly found steps and ramps daunting; 20% found uneven, narrow sidewalks difficult. Engineering guidelines for persons with disabilities are not implemented.

Urbanity and life style

Correlation between active transportation (walking and cycling) and obesity: China – 1.8kg weight gain after and twice as likely to get obese for a Chinese who acquired a car. King County, US – people weigh 7 pounds less on an average in walkable neighbourhoods

Unacceptably high accident rates.....

Total number of road accidents are very high in Delhi – 2.5 times higher than that of Kolkata, 2.1 times higher than Chennai – personal vehicles cause most of these accidents...

Nearly half of fatal accidents in Delhi involve – pedestrians.

Source: Walkability Roundtable, Centre for Science and Environment, July 2009

2. Existing Frameworks



Existing Frameworks and Legislation

A. National Urban Transport Policy 2006 recommends to ensure safe, affordable, quick, comfortable, reliable and sustainable access for the growing number of city residents to jobs, education, recreation and such other needs within our cities. This is sought to be achieved by:

- Incorporating urban transportation as an important parameter at the urban planning stage rather than being a consequential requirement
- Encouraging integrated land use and transport planning in all cities so that travel distances are minimized and access to livelihoods, education, and other social needs, especially for the marginal segments of the urban population is improved.
- Improving access of business to markets and the various factors of production
- **Bringing about a more equitable allocation of road space with people, rather than vehicles, as its main focus.**
- **Encourage greater use of public transport and non-motorized modes** by offering Central financial assistance for this purpose
- **Enabling the establishment of quality focused multi-modal public transport systems that are well integrated, providing seamless travel across modes**
- Establishing effective regulatory and enforcement mechanisms that allow a level playing field for all operators of transport services and enhanced safety for the transport system users
- Establishing institutional mechanisms for enhanced coordination in the planning and management of transport systems
- **Introducing Intelligent Transport Systems for traffic management**
- Addressing concerns of road safety and trauma response
- Reducing pollution levels through changes in travelling practices, better enforcement, stricter norms, technological improvements, etc.
- Building capacity (institutional and manpower) to plan for sustainable urban transport and establishing knowledge management system that would service the needs of all urban transport professionals, such as planners, researchers, teachers, students, etc.
- Promoting the use of cleaner technologies
- Raising finances, through innovative mechanisms that tap land as a resource, for investments in urban transport infrastructure
- Associating the private sector in activities where their strengths can be beneficially tapped
- Taking up pilot projects that demonstrate the potential of possible best practices in sustainable urban transport

Existing Frameworks and Legislation

- B. Current IRC Guidelines for Pedestrian and Cycle track design** provide basis standards for pedestrian and cycle oriented design but need more augmentation.
- C. Masterplan of Delhi 2021 specifies:**
 - A. All roads should be made pedestrian, disabled and bicycle friendly.
 - B. Provision of adequate pedestrian facilities.
 - C. Removal of encroachments from sidewalks.
 - D. Provision for introducing cycle tracks, pedestrian and disabled friendly features in arterial and sub-arterial roads.**
 - E. In urban extension, cycle tracks should be provided at the sub-arterial and local level roads and streets.**
 - F. In specific areas, like the Walled City / Chandni Chowk / Sadar Bazar / Karol Bagh / Lajpat Nagar and Trans Yamuna Area, the use of cycles/rickshaw as a non-motorised mode of transport should be consciously planned along with pedestrianisation.
 - G. On all roads with ROW greater than 30 m exclusive bus lanes will be planned to implement the Bus Rapid Transit System (BRTS) in a phased manner to cover the whole city.**
- D. EPCA, Supreme Court directive on increased use of Public Transport in Delhi.**

“Over the years, it has become clear that each city is fighting a losing battle against air pollution and growing congestion — because of the growing numbers of vehicles. Economic progress of our cities will depend on their environmental health. A turnaround is only possible when cities recognize the need for a transition to public transport and adopt it.”

The following UTTIPEC, DDA Guidelines will work towards augmenting and strengthening the above city level targets and frameworks.

Existing Frameworks and Legislation

Many City level Laws converge to safeguard the safety of pedestrians:*

- Central Motor Vehicles rules (CMVR) 1989 Safety Rules provide passive protection for pedestrians, stating that **motorists cannot enter pedestrian way and are liable to penalty.**
- Indian Penal Code (sec 283), sec 34 of Delhi Police Act -- **Obstruction in public space punishable.**
- Urban street vendor policy, 2007, to protect livelihood rights – recommend Guidelines for proper vending zones, as they are service providers on sidewalks...
- The National Policy on Urban Street Vendors, 2009, approved by the Central government, recognizes street vendors (or micro-entrepreneurs) as “an integral and legitimate part of the urban retail trade and distribution system.” The national policy gives **street vendors a legal status and aims at providing legitimate vending/hawking zones** in city/town master or development plans.
- Police Act provides for **penalty for jaywalking.**
- Design and engineering guidelines by Indian Road Congress (IRC) are currently being revised and updated.
- Persons with Disabilities Act 1995 (Sec 44) recommends guidelines for the disabled persons.

The following UTTIPEC, DDA guidelines will work towards augmenting and strengthening the above city level targets and frameworks.

**Source: Walkability Roundtable, Centre for Science and Environment*

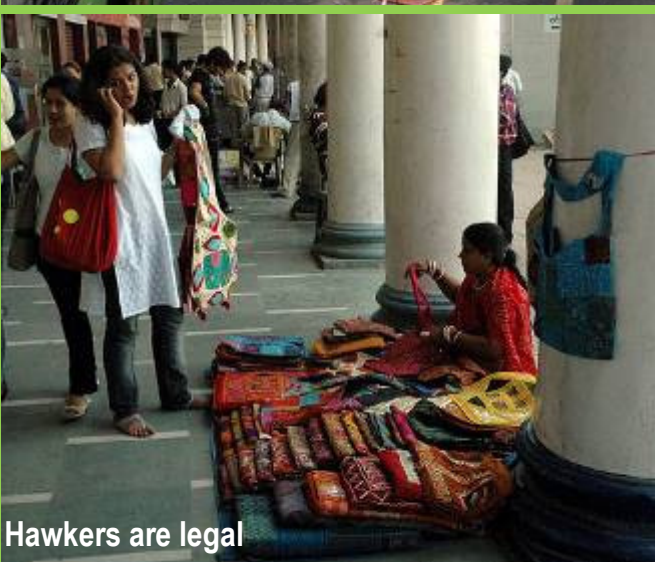

3. Essential Goals



GOALS FOR “INTEGRATED” STREETS FOR DELHI:



**GOAL 1:
MOBILITY AND
ACCESSIBILITY –**
Maximum number of people should be able to move fast, safely and conveniently through the city.

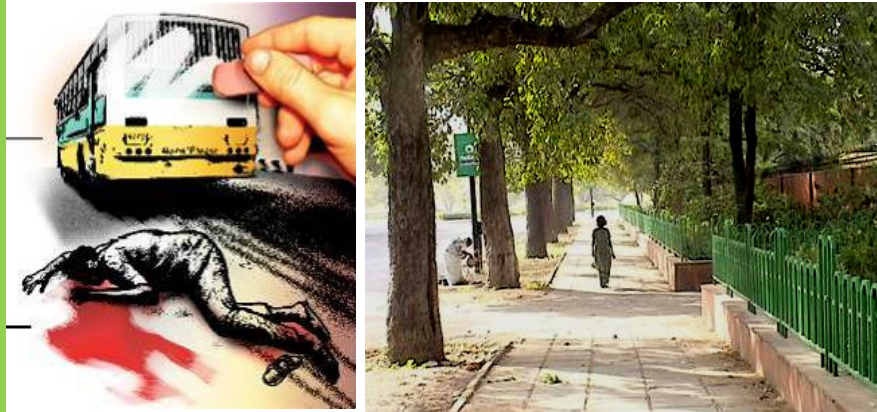

**GOAL 2:
SAFETY AND
COMFORT –**
Make streets safe clean and walkable, create climate sensitive design.



**GOAL 3:
ECOLOGY –**
Reduce impact on the natural environment; and Reduce pressure on built infrastructure.

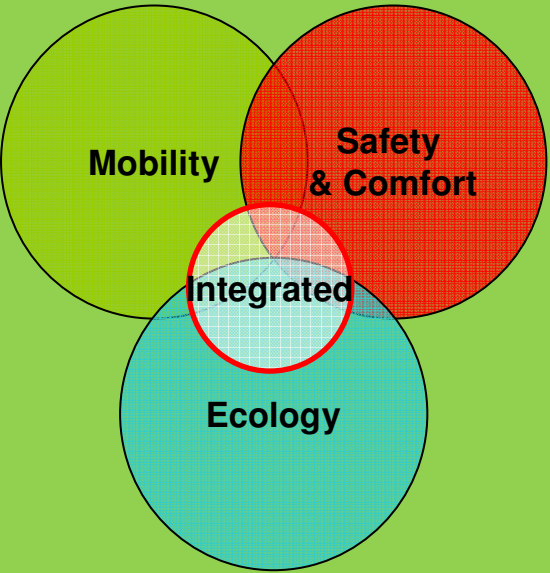

Essential Components of all Streets



Pedestrian sidewalks & crossings



Non motorized vehicles



Utilities



Physically challenged



Motorized private vehicles



Public Toilets



Trees



Rainwater harvesting



Shaded Bus stops

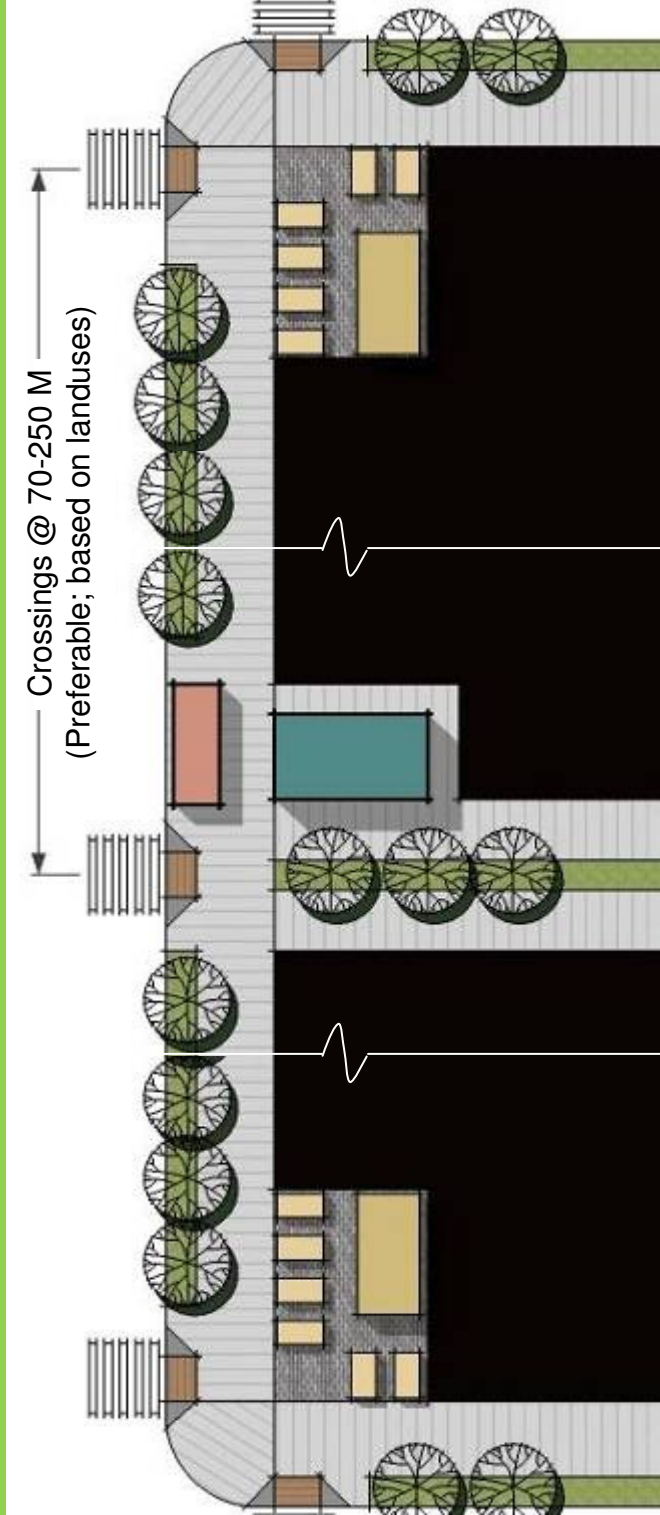

Mobility Goals:

Ensure preferred public transport use

To ensure preferable public transport use:

1. To Retrofit Streets for equal or higher priority for Public Transit and Pedestrians.
2. Provide transit-oriented mixed landuse patterns and redensity city within 10 minutes walk of MRTS stops.
3. Provide dedicated lanes for HOVs (high occupancy vehicles) and carpool during peak hours.

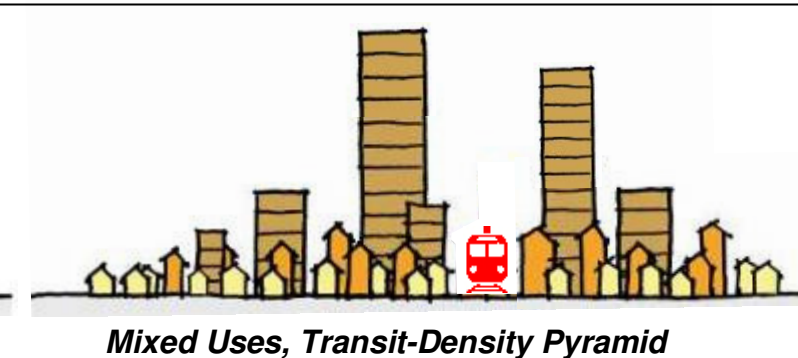
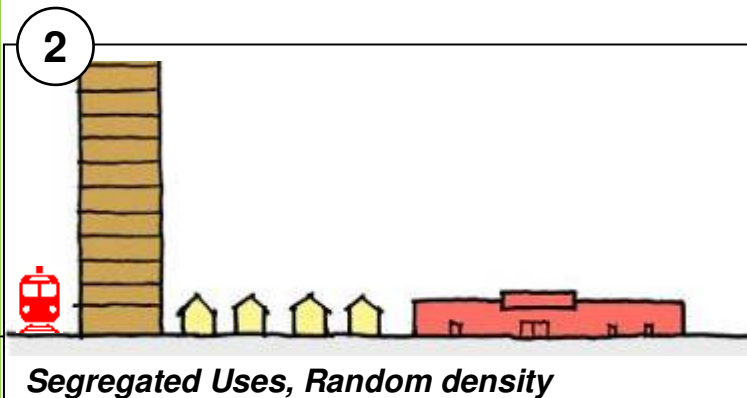

Provide safety, comfort and amenities to all users

Safety, Comfort Goals:

To ensure pedestrian safety:

4. Create “eyes on the street” – by removing setbacks and boundary walls and building to the edge of the street ROW. This would allow people from inside to look out on to the pavement, thus discouraging misbehavior, shady corners, peeing, etc.)
5. In case enclosure of sites is required, transparent *fencing* should be used above 300 mm height from ground level.
6. Require commercial facades to have minimum 30% transparency.
7. Provide adequate Street Lighting for pedestrians and bicycles.
8. Create commercial/ hawking zones at regular intervals (10 minute walk from every home in the city) to encourage walkability, increase street activity and provide safety. (e.g. Mumbai, Shanghai)

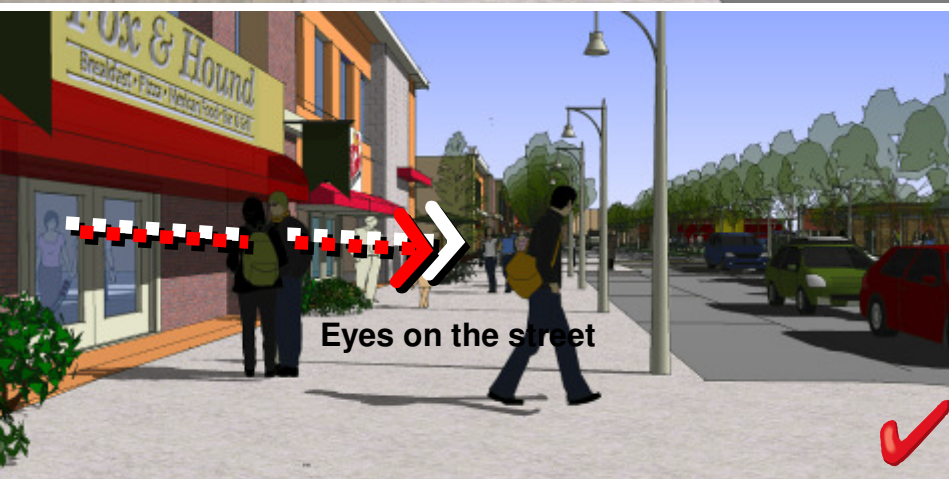

Safety, Comfort Goals:

Provide climatic comfort



8



9

10

For climatic comfort:

8. *Trees* are an essential component for all streets – to provide shade to pedestrians and reduce solar gain.
9. *High albedo* (diffuse reflectivity) materials for paving reduces urban heat island effect.
10. Built to Pavement edge buildings with overhangs and arcades provide excellent protection to pedestrians.

Provide universal accessibility and civic amenities

Safety, Comfort Goals:

11

12



To ensure universal accessibility and amenities for all street users:

11. Provide at-grade crosswalks (and overpasses on highways) at maximum intervals of ~70-250 M, aligning with location of transit stops, type of street / landuse activities and neighboring building entries and destinations.
12. Provide Dustbins, postboxes, signage and other public amenities at street corners for high usability.
13. Provide Accessible Public Toilets at every 500 -800 M distance – preferably located close to bus stops for easy access by pedestrians and public transport users.
14. Follow universal accessibility design standards to make public streets & crosswalks fully navigable by the physically handicapped.

13



14



*Handicapped Ramps,
Tactile Paving*

Ecological Goals:

Reduce heat island effect & aid storm water management.

To reduce urban Heat Island Effect and aid natural storm water management:

- 15. Decrease impervious surfaces through permeable paving, tree planting zones, etc. to increase ground water infiltration & prevent seasonal flooding.
- 16. Integrate Natural Storm Water filtration and absorption into street design through bio-filtration beds, swales and detention ponds.
- 17. Decrease Heat Island Effect (HIE) by increasing greenery, planting trees, using reflective paving, etc.



Permeable Paving



Infiltration beds



Bio-filtration beds

15

16

17

4. Street Hierarchy of Delhi with Categorization by Function.

Road Network Hierarchy of Delhi:

National Urban Transport Policy 2006 recommends:

- i. Equitable distribution of road space between all road users
- ii. Priority to the use of public transport
- iii. Priority to non-motorized modes

Masterplan of Delhi 2021 specifies:

- i. All roads should be made pedestrian, disabled and bicycle friendly.
- ii. Provision of adequate pedestrian facilities.
- iii. Provision for introducing cycle tracks, pedestrian and disabled friendly features in arterial and sub-arterial roads.**
- iv. In urban extension, cycle tracks should be provided at the sub-arterial and local level roads and streets.
- v. On all roads with ROW greater than 30 m exclusive bus lanes will be planned to implement the Bus Rapid Transit System (BRTS) in a phased manner to cover the whole city.**



Masterplan-2021 Road Hierarchy:

1. National Highways.

The recommended minimum right of way (ROW) is **90 meters**, wherever possible. However, within the city it shall not be less than 60 meters. All the National Highways within the NCTD shall be access controlled upto the Delhi Border.

2. Arterial Roads.

These include primary roads with access control and other primary roads.

- i) **Primary Roads:** Vehicular routes carrying heavy volumes of traffic will generally have free / stable flow conditions with controlled access. The recommended ROW in existing urban area is **60-80 m.** and minimum 80 m. in the proposed urban extension. While designing roads with 30m. ROW and above, provision should also be made for public mass rapid transport system, which may include BRT. Present ring road and outer ring road to be converted to access controlled arterial roads. Cycle tracks should also be constructed along all arterial roads wherever possible.
- ii) **Other Primary roads:** Vehicular routes carrying heavy volumes of traffic, BRT route may also be allowed on these roads. The recommended ROW in existing urban area is **45-60 M.** and minimum 60 m. in the proposed urban extension. Cycle tracks should also be constructed along all other primary roads wherever possible.

3. Sub Arterial (Collector) Streets.

These include primary and secondary collector streets.

- (i) **Primary Collector:** These roads will connect major arterial roads and inter residential district collectors. The recommended ROW in existing urban area is **30-40 M.** and minimum 45 M. in the proposed urban extension. In addition to this, a separate cycle track should be provided wherever possible.
- (ii) **Secondary Collector:** These roads are intended to collect traffic from local streets within one residential district. The recommended R/W in existing urban area is **18-24 M.** and minimum 30 M. in the proposed Urban extension.

4. Local Streets.

These are intended for neighbourhood (or local) use on which through traffic is to be discouraged. The suggested ROW is **12 to 20 m.** in the existing and proposed urban area. These roads should be made pedestrian and bicycle friendly by using modern traffic calming designs to keep the speeds within limits as per design.

Exclusive Pedestrian Only Streets (6 M and less) as per the provisions in MPD 2021 be identified area by area, by the local bodies/ road owning agencies.

Design Principles and Functional Characteristics

1. National Highways.

Only have an inter-city role. When National highways pass through Urban Areas, they become Urban Arterials.

2. Arterial Roads.

Provides long distance mobility between various parts of the city.

3. Sub Arterial (Collector) Streets.

Provides local connections between neighbourhoods and also connects neighbourhoods to Arterial Roads.

4. Local Streets.

Dominant function is to provide local connectivity. Can provide connections between neighbourhoods with dominance to walking and non-motorized movement.

5. Exclusive Pedestrian & NMV Only Streets

Where pedestrian and non-motorized transport are the dominant mode. Particularly applicable to intensely commercialized areas.

Major Street Design Principles:

1. **Safety** of all modes and **Universal Accessibility** of all Streets.
2. **Priority** to public transport users.
3. **Climatic comfort** essential for all road users. Planting of deciduous trees along all footpaths and non-motorized lanes is essential
4. **Ecological design** to minimize environmental impacts like urban heat island effect, storm water runoff, etc.
5. **Amenity** provisions and facilities for all road users is mandatory on all roads, to ensure safety, usability and vibrancy of the street. Therefore designated spaces to be provided for amenities like hawkers, public toilets, street lights, utilities, para-transport drop-offs, etc.
6. **Segregation between modes (by speed)** to be provided if difference in desirable speed of different modes becomes more than 10 km/hr. For example, In areas with high volume of non-motorized through traffic (cyclists), speed of cyclists may be at or above 15km/hr, while speed of pedestrians is below 5 km/hr. So then segregation between the spaces allocated to both is required. Similarly, when desirable speed of motorized traffic is above 25 km/hr and maximum speed of non-motorized traffic is only 15 km/hr, it is required to spatially segregate the two in order to increase safety and efficiency of both types of modes.
7. **Segregation between modes (for priority)** is required when priority is to be provided to public transport and non-motorized transport (both for speed, congestion-free movement, safety and junction clearance) as per principles outlines in the National Urban Transport Policy.
8. **Efficiency** of movement of all modes is to be provided through design.

Masterplan-2021 Road Hierarchy: Categorization*

	Primary Arterial	Other Primary Arterial	Primary Collector	Secondary Collector	Local Streets
RIGHT OF WAY	60-80 M	45-60 M	30-40 M	18-24 M	12-20 M
SPEED RANGE	50 – 70 km/hr	30 - 40 km/hr.	20 - 30 km/hr	10- 20 km/hr	10-20 km/hr
SPEED CONTROL	Enforcement and Traffic Calming required	Enforcement and Traffic Calming required	Enforcement and Traffic calming required.	Traffic calming essential.	Traffic calming required
BUSWAYS FOR BRT	Segregated busways required where BRT proposed	Segregated busways required where BRT proposed	Segregated busways required where BRT proposed , at-grade segregation possible on R/Ws above 36 M	No segregated bus lane; but Road may be designated Bus-NMV only if required	No segregated bus lanes or bus operations required; but Road may be designated Bus-NMV only if required
MOTORIZED LANES	2 to 4 motorized lanes per direction, min. 3.3 m wide (min. 3.5 for BRT busways)	2 to 4 motorized lanes per direction, min. 3.3 m wide (min. 3.3 for BRT busways)	2 to 3 motorized lanes per direction, min. 3.1m wide (min. 3.3 for BRT busways)	No minimum lane width specification.	No minimum lane width specification.
CYCLE/ NMV TRACKS	Segregated cycle tracks required ; min. 2.5 m wide for two-way movement.	Segregated cycle tracks required ; min. 2.5 m wide for two-way movement.	Traffic Calming essential where segregated Cycle tracks are not provided; Cycle tracks to be min. 2.5 m wide if block lengths are >250m.	Cycle lanes can work, segregated tracks required where friction & encroachment expected	No special feature for cyclists
SERVICE LANES	Service lanes required.	Service lanes required for low-density residential frontages; for commercial / MU frontages, service lanes not required.	No service lane required	No service lane required	No service lane required
MEDIANS	Continuous median ; all openings and intersections accompanied by signals and traffic calming. (no grade separators within city)	Continuous median ; all openings and intersections accompanied by signals and traffic calming. (no grade separators within city)	Intermittent or No median ; openings/ intersections accompanied by signals and traffic calming.	Intermittent or No median required; For roads where need for Median is felt, issue to be brought to UTTIPEC. Crossings to be traffic calmed.	No medians ; traffic calmed crossings, or mini roundabouts

NOTE: Lane Widths have been designated based on desired speed of the road category.

* Guidelines prepared by UTTIPEC, DDA; Revised and Updated in Nov 2010.

60 M Primary Arterial Road – Access Controlled

IRC CROSS SECTION ARTERIAL STREET (4 LANE DIVIDED)

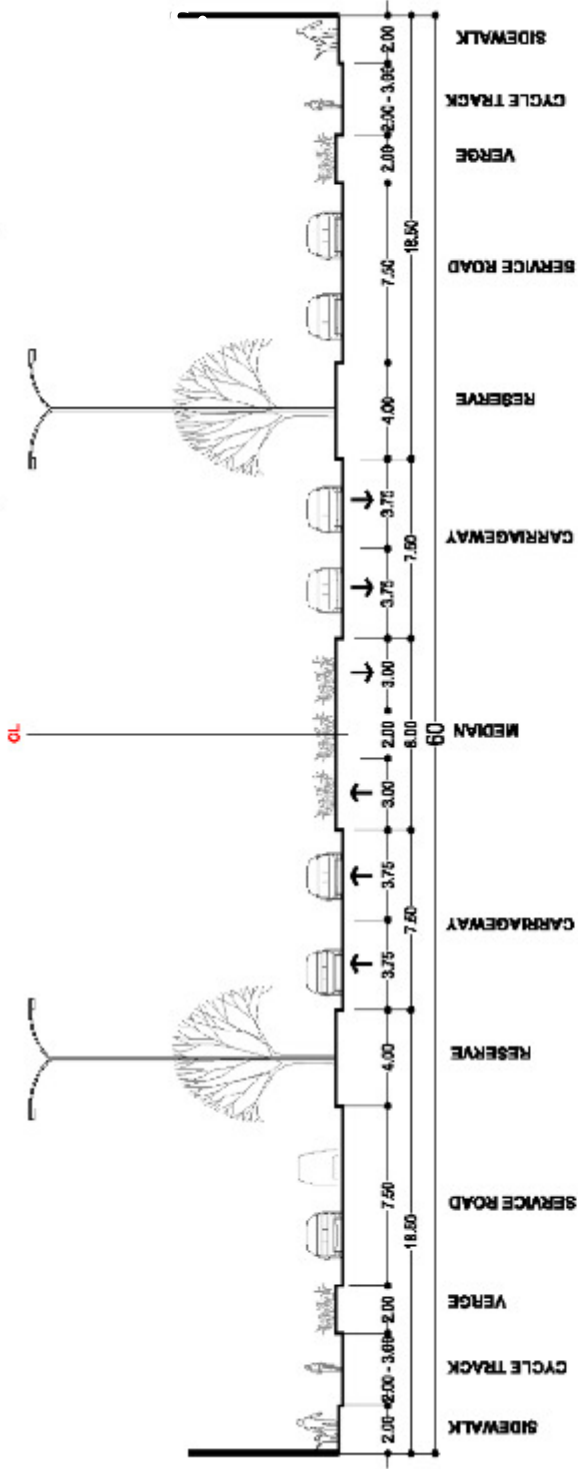

UTTIPEC CROSS SECTION - 60 M ROAD WITH BRT / METRO - at MID-BLOCK

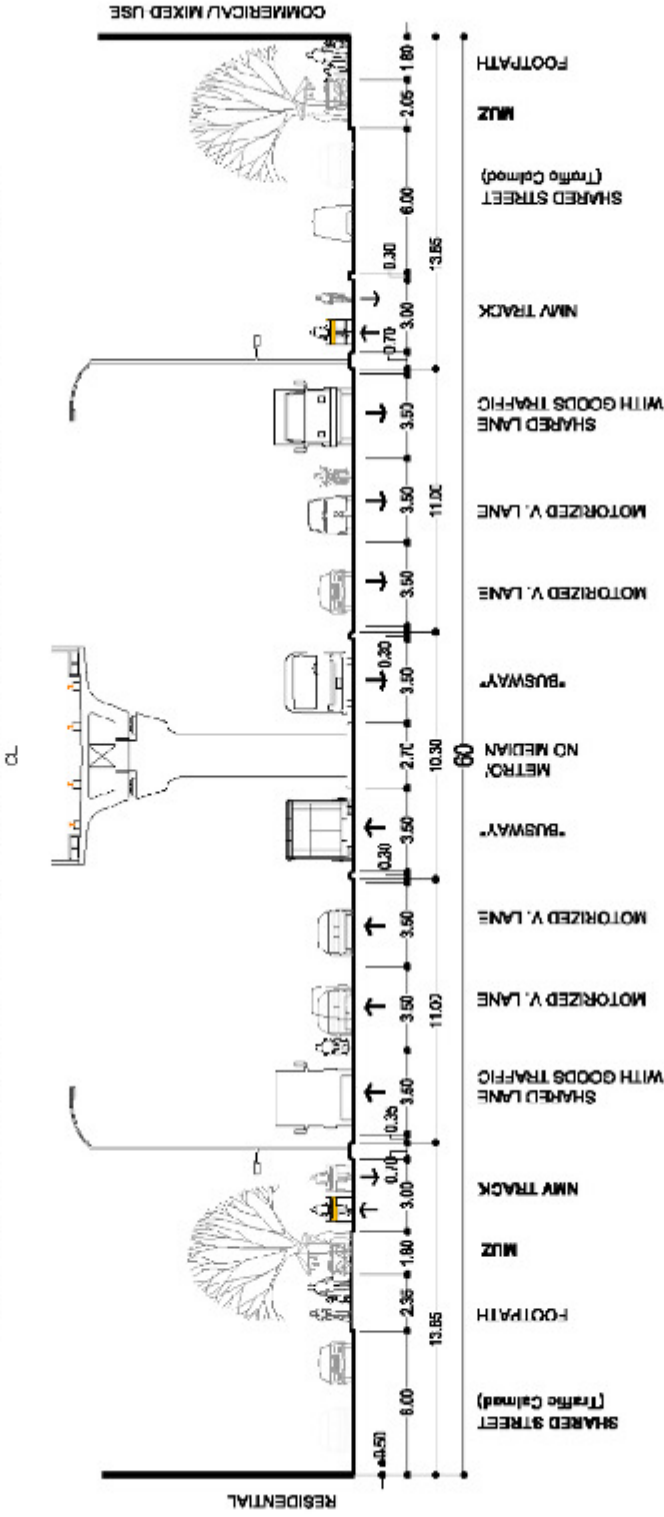

UTTIPEC CROSS SECTION - 60 M ROAD WITH BRT / METRO - at BUS STATION

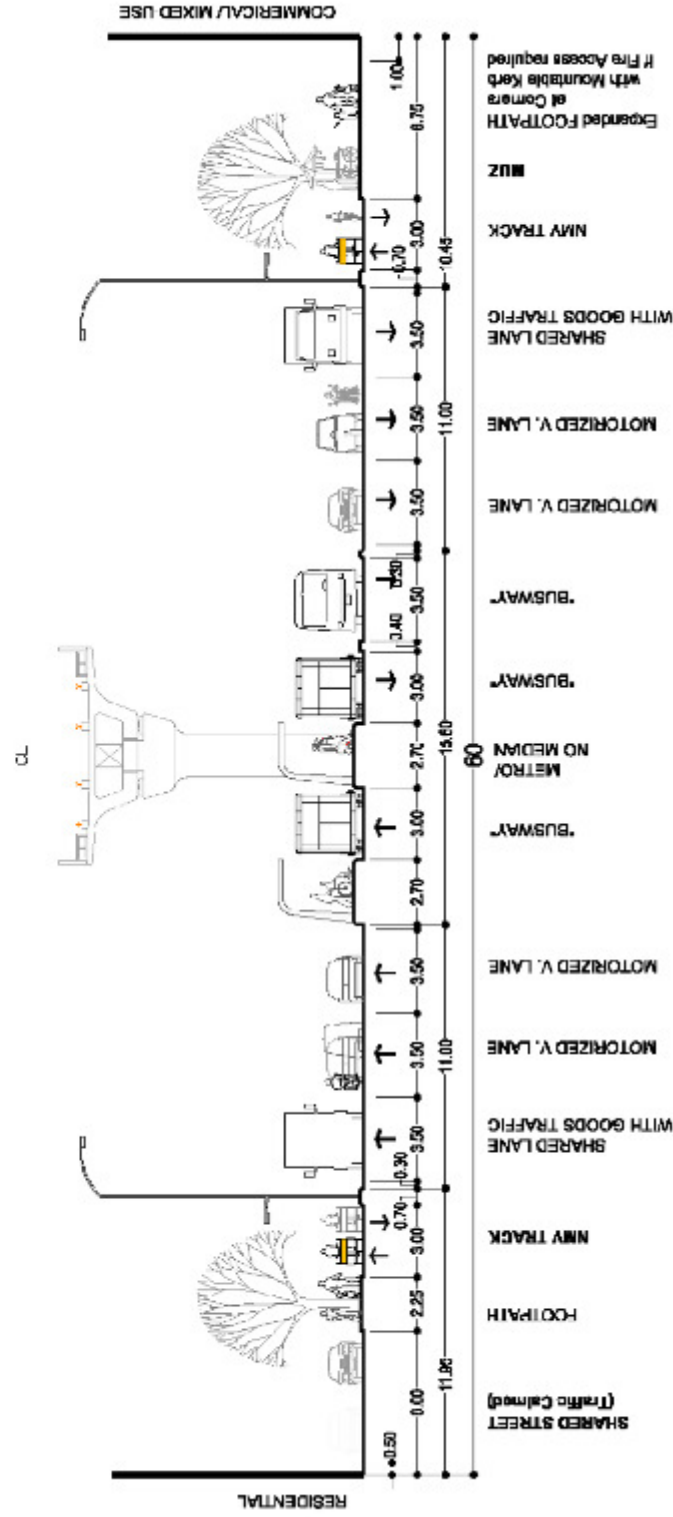

45 M Other Primary Arterial Road – Residential Edges

IRC CROSS SECTION EXPRESSWAY (4 LANE DIVIDED)

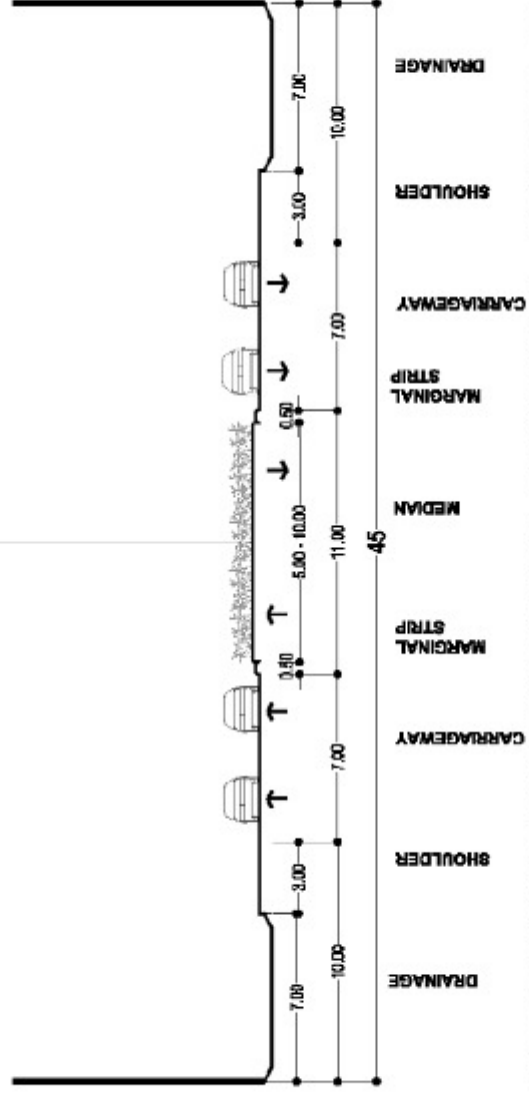

i) 45 m ROAD WITH BUSWAYS/ METRO at MID-BLOCK - with Service Lane

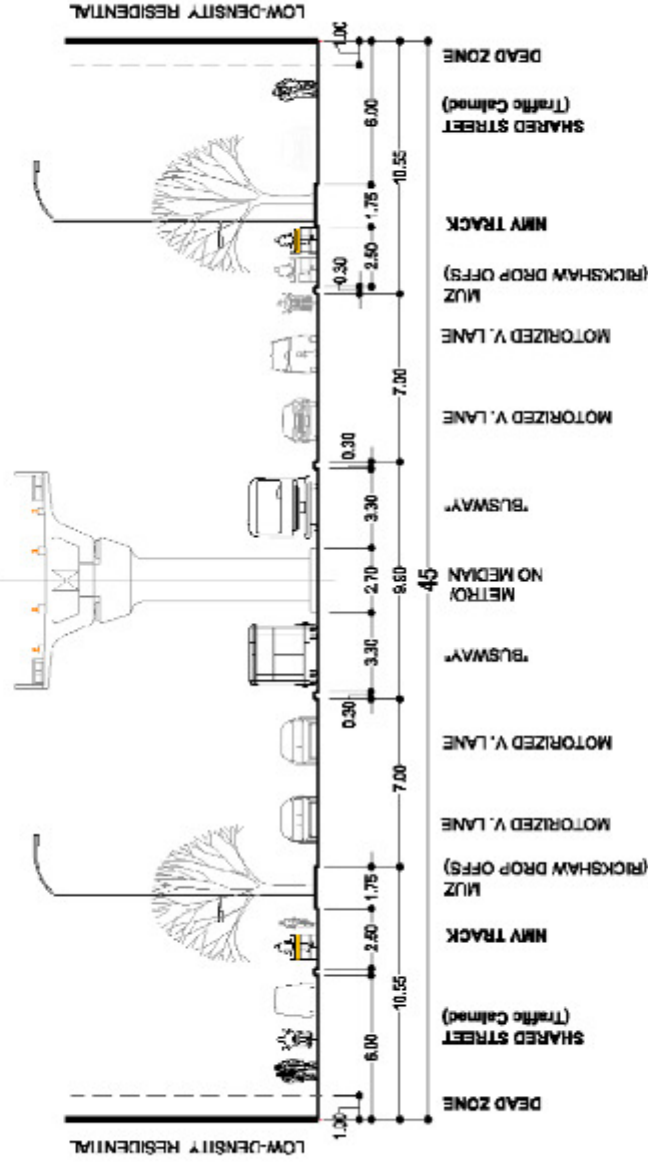

ii) 45 m ROAD WITH BUSWAYS/ METRO at JUNCTION - Residential Frontage

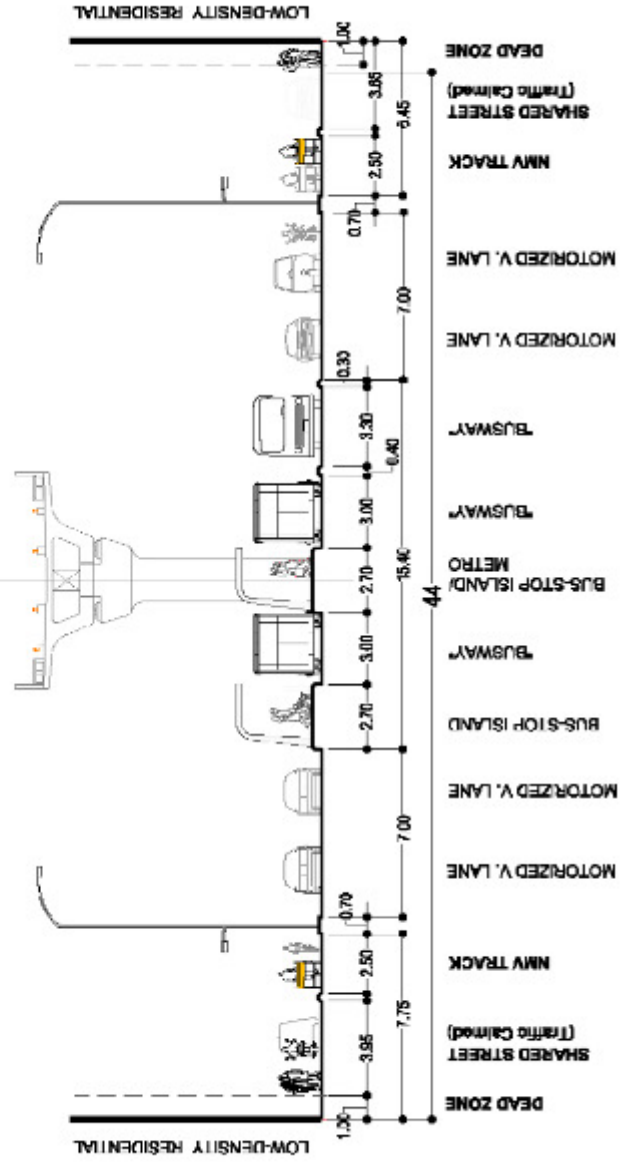

45 M Other Primary Arterial Road – Commercial Edges

IRC CROSS SECTION EXPRESSWAY (4 LANE DIVIDED)

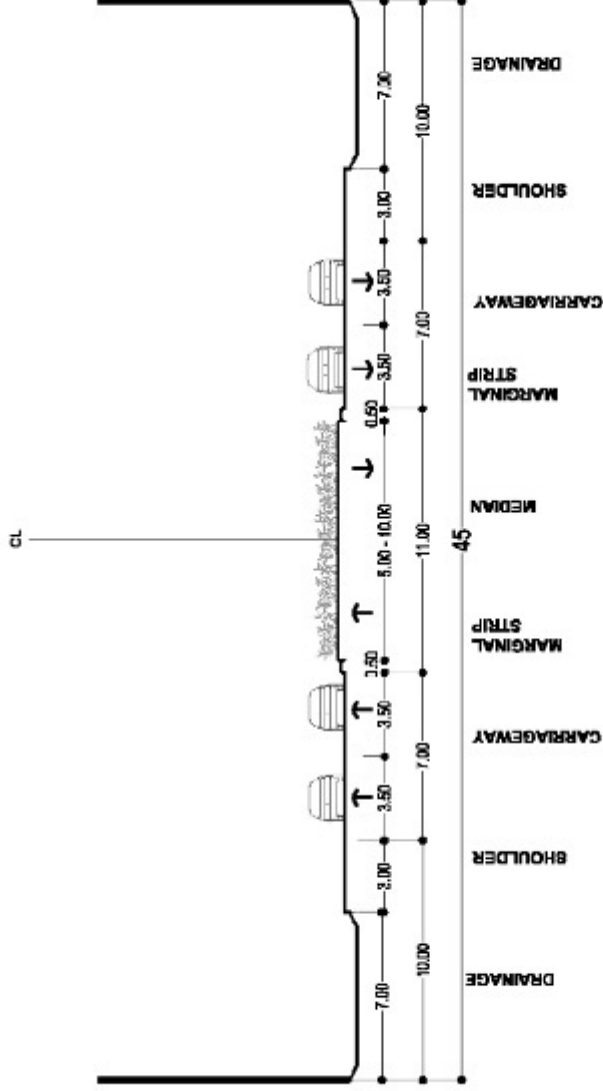

45 m ROAD WITH BUSWAYS + METRO - Commercial Frontage at MID-BLOCK

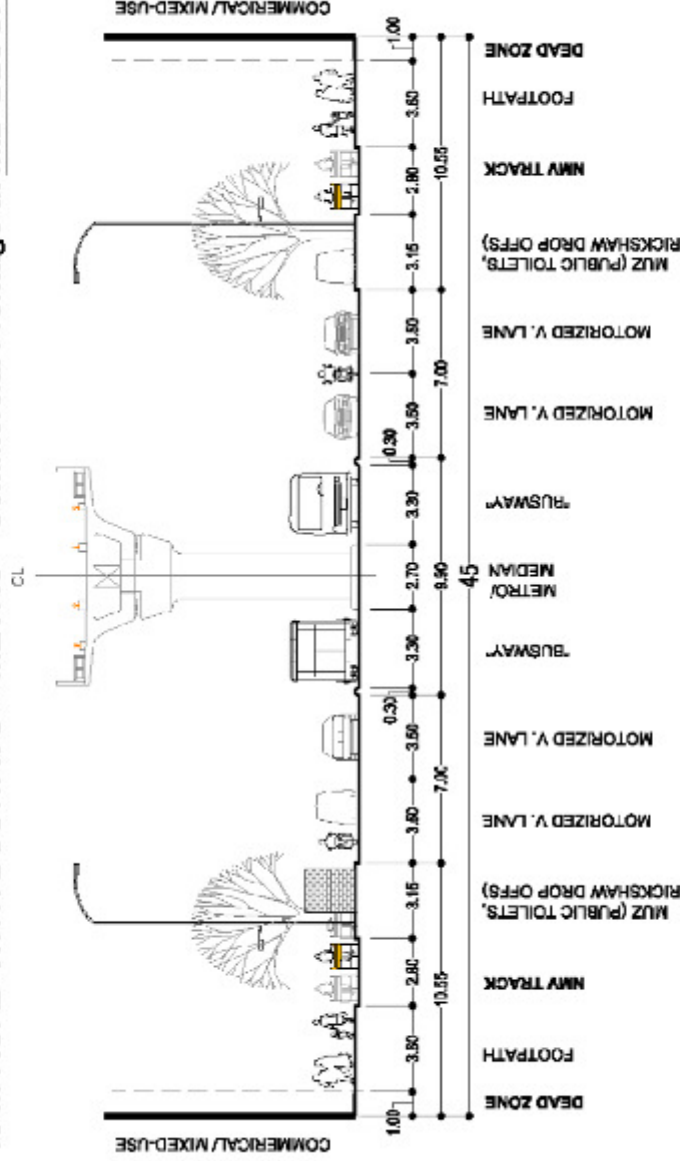

45 m ROAD W/ BUSWAYS + METRO - Commercial Frontage at JUNCTION

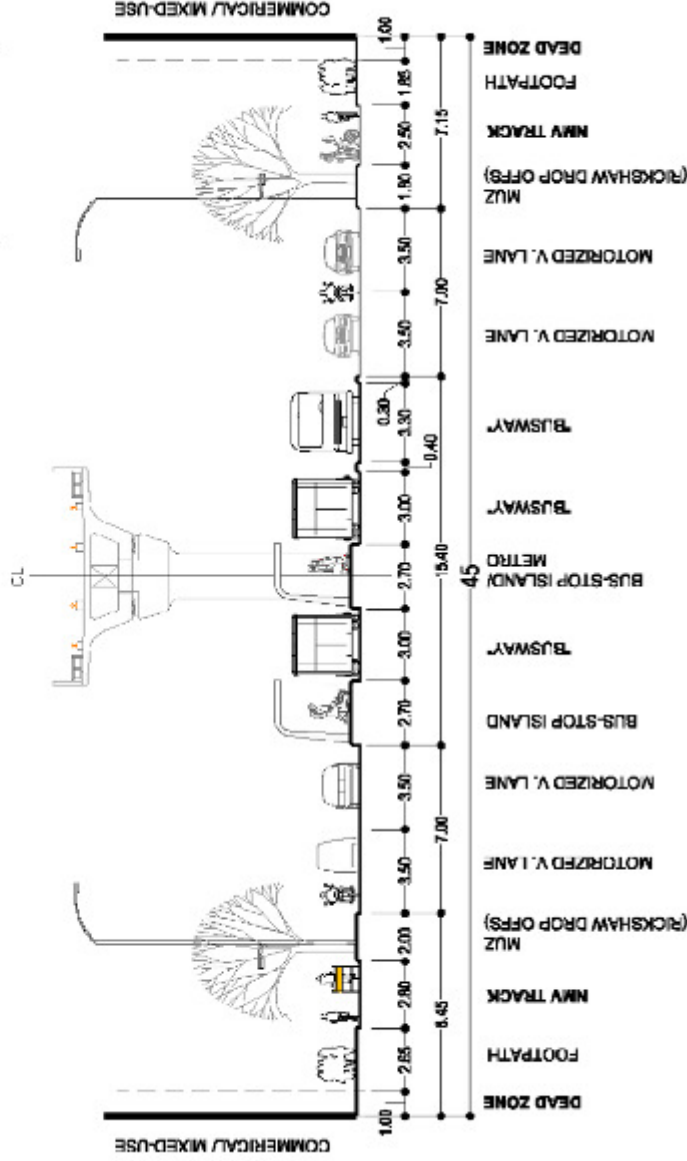

45 M Other Primary Arterial Road – Any Use Edge Condition

IRC CROSS SECTION EXPRESSWAY (4 LANE DIVIDED)

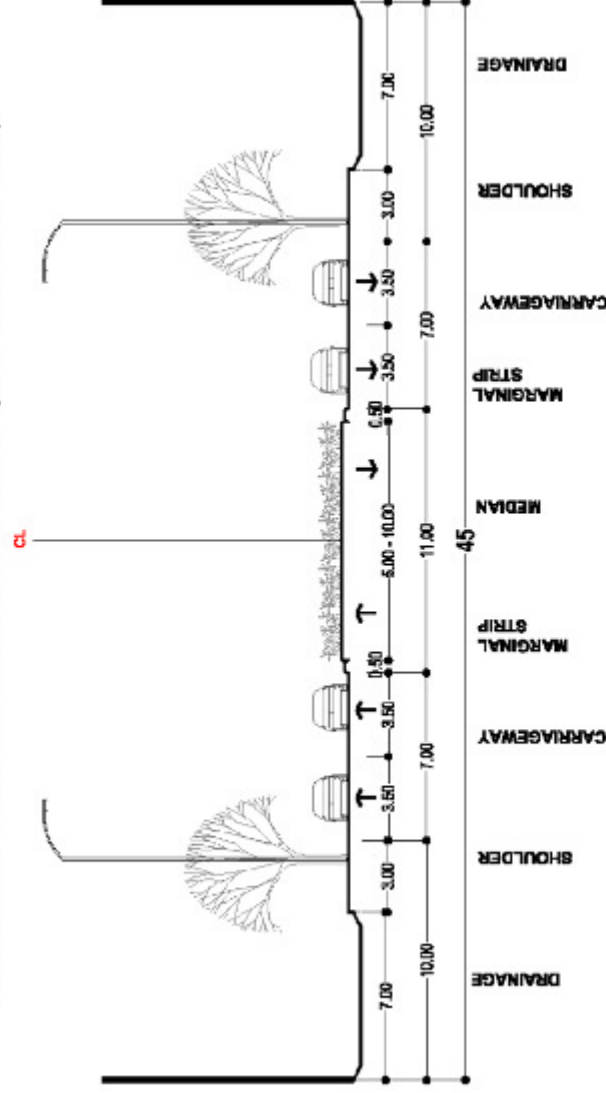

45 M ROAD WITH BUSWAYS - Commercial or Residential at MID-BLOCK

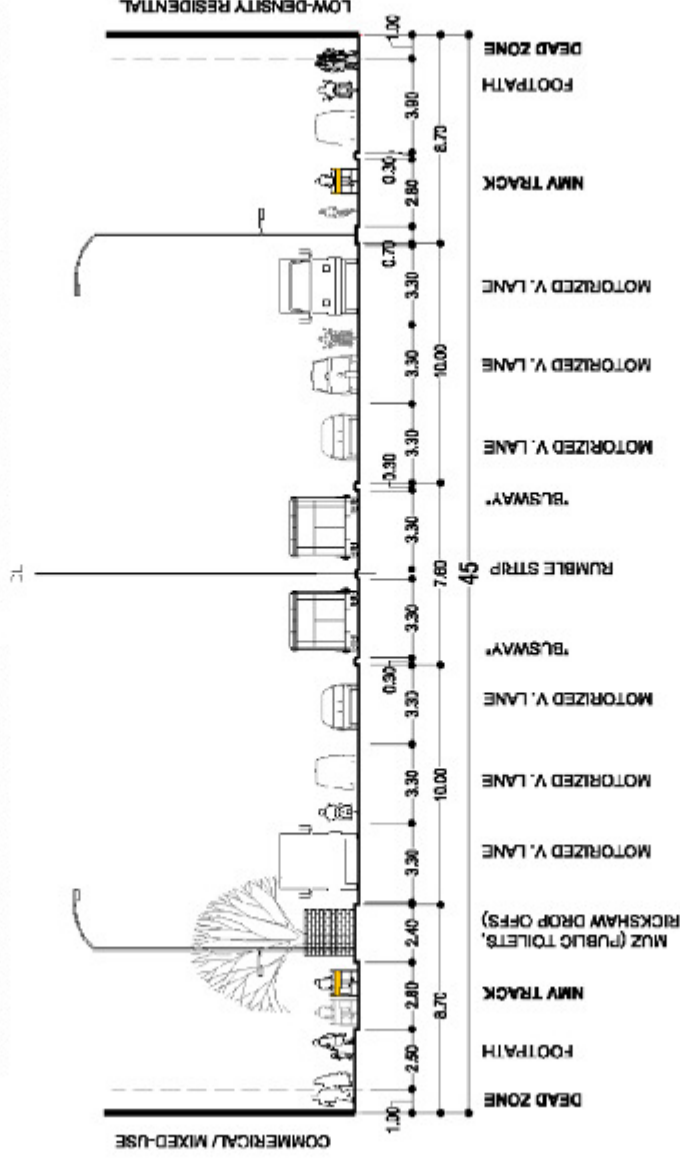

45 M ROAD WITH BUSWAYS - Commercial or Residential at BUS STATION

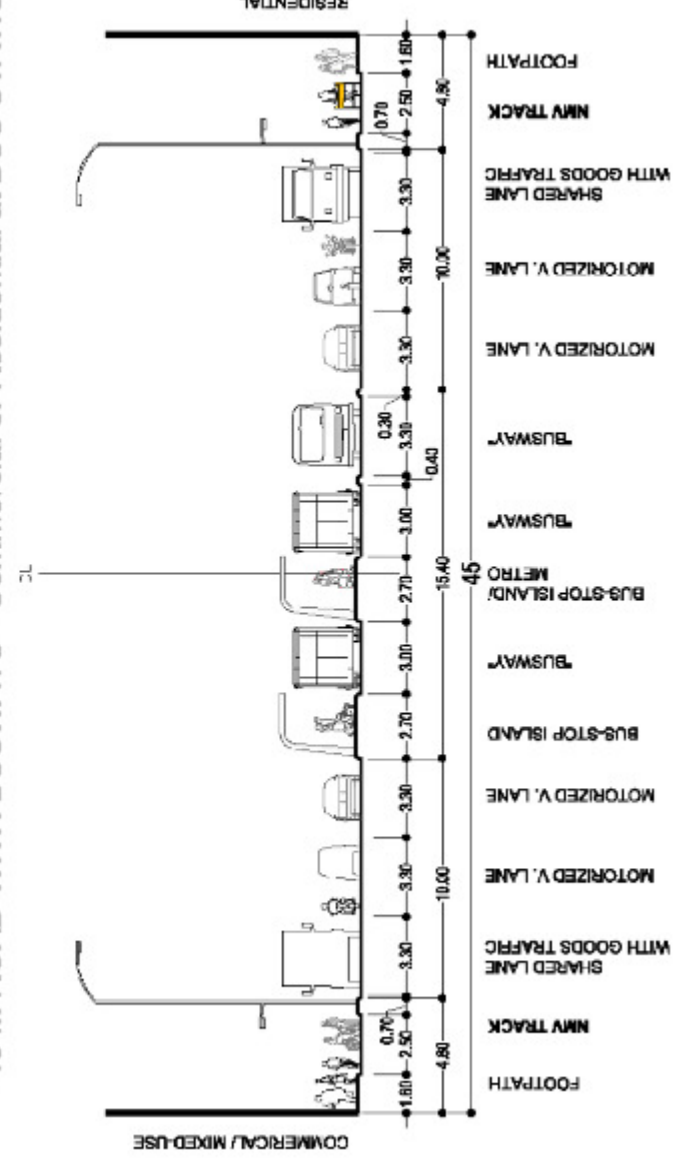

40 M Primary Collector Road – Functioning as Arterial

IRC 40 M SUB ARTERIAL STREET WITH EXTRA PARKING LANE
(4 Lane Divided)

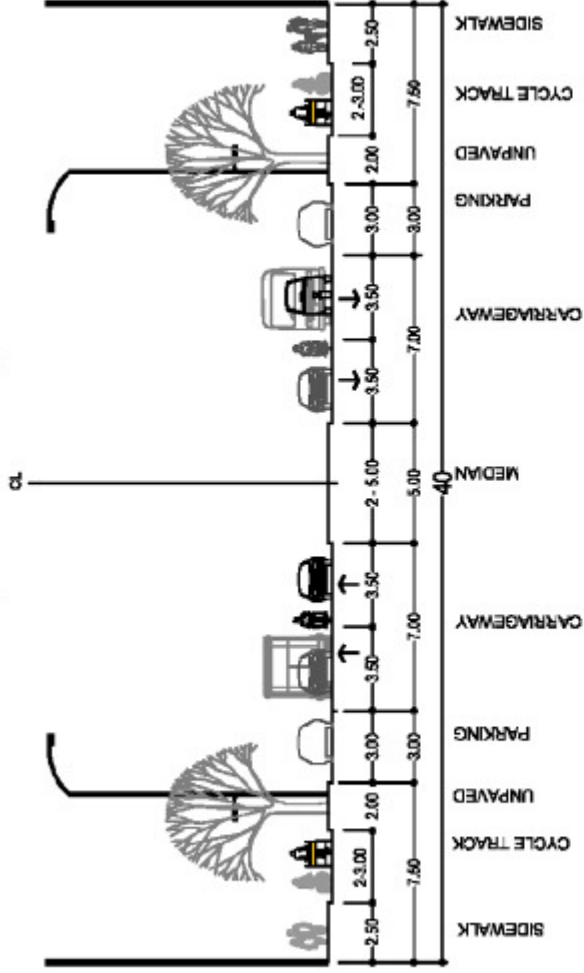

40 m ROAD WITH BUSWAYS & NMV-TRACKS at MID-BLOCK-
Arterial Road Function

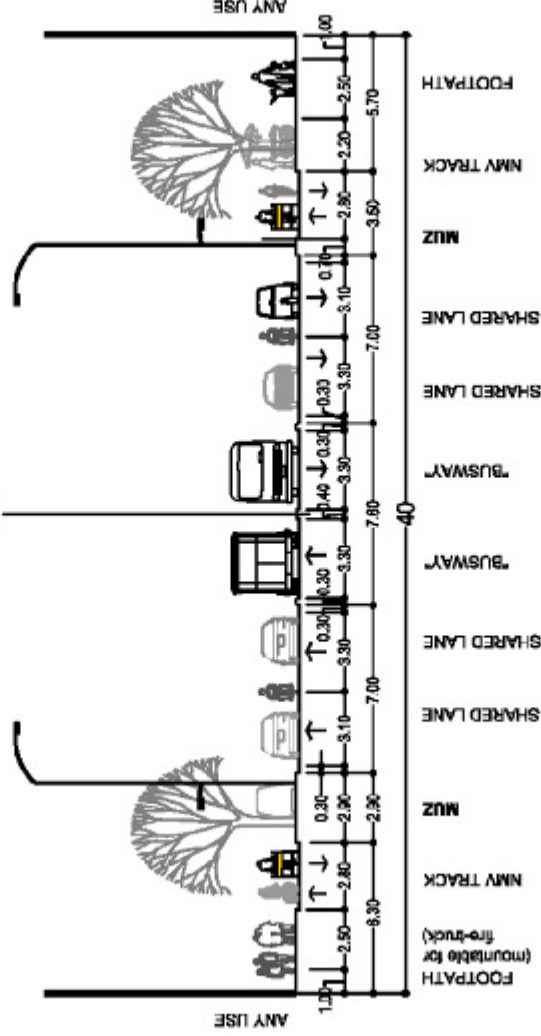

40 m ROAD WITH BUSWAYS & NMV-TRACKS at JUNCTION-
Arterial Road Function

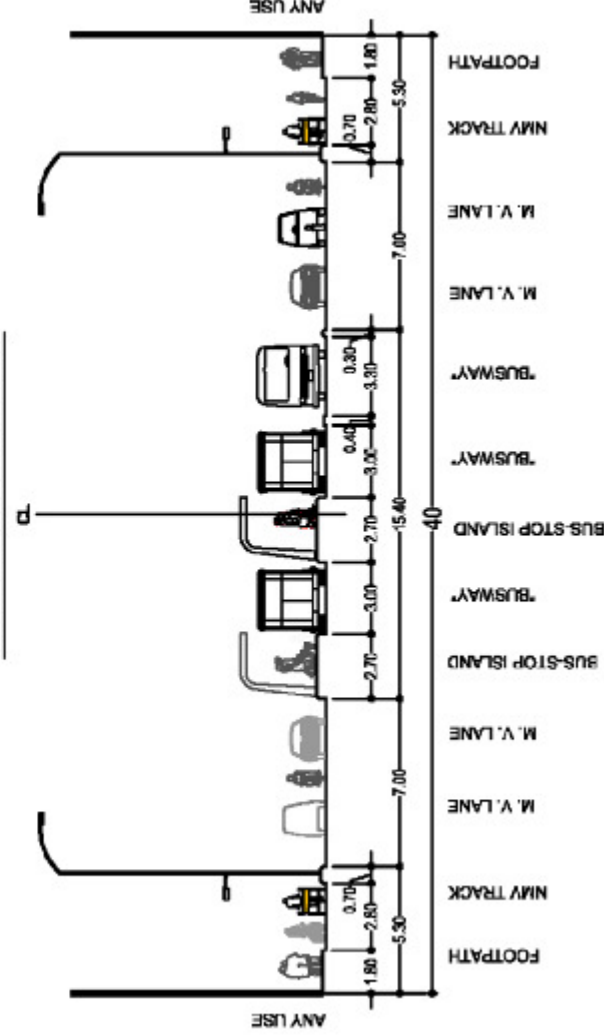

NOTE: Non-motorized lanes/ Cycle Tracks are OPTIONAL on R/Ws below 40m Width. In case smoother flow of motorized traffic is desired, one "Shared Lane" may be replaced by a dedicated Non-motorized Lane; to reduce *friction between slow and fast moving vehicles*.

30 M Primary Collector Road

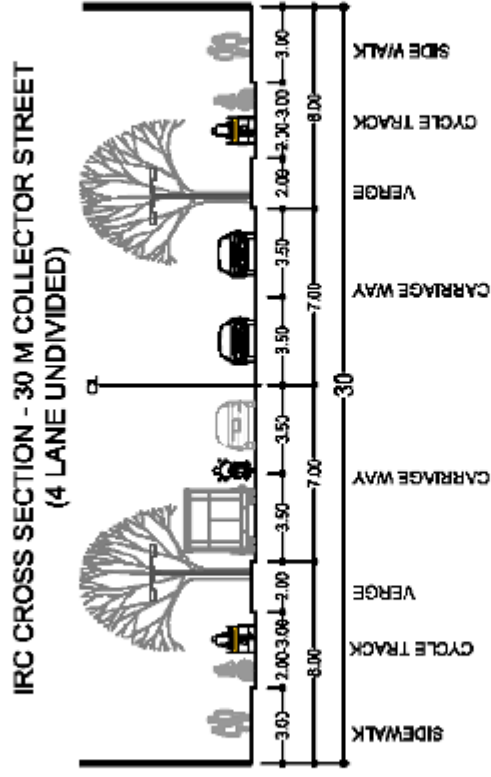

1) 30 M ROAD WITH METRO & MIXED TRAFFIC (Design Speed <20km/hr) Collector/ Neighbourhood Road Function

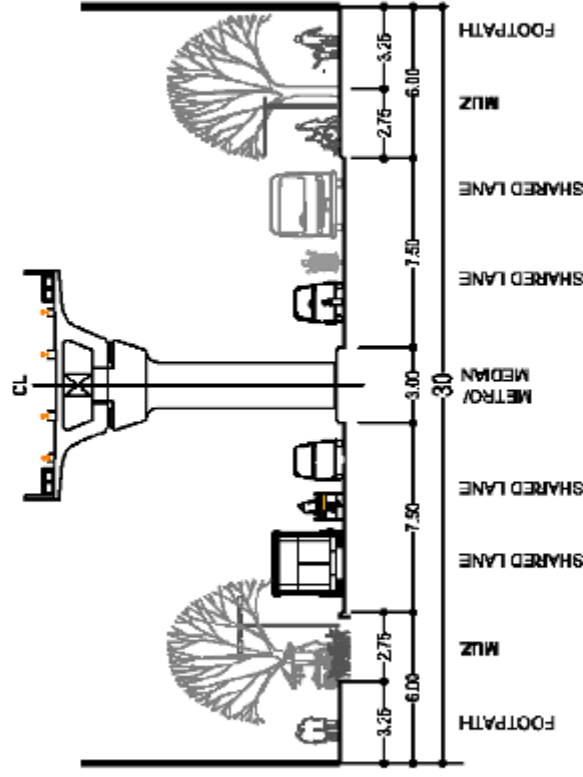

30 M ROAD WITH 6-Lane MIXED (Design Speed <20km/hr) Collector/ Neighbourhood Road Function

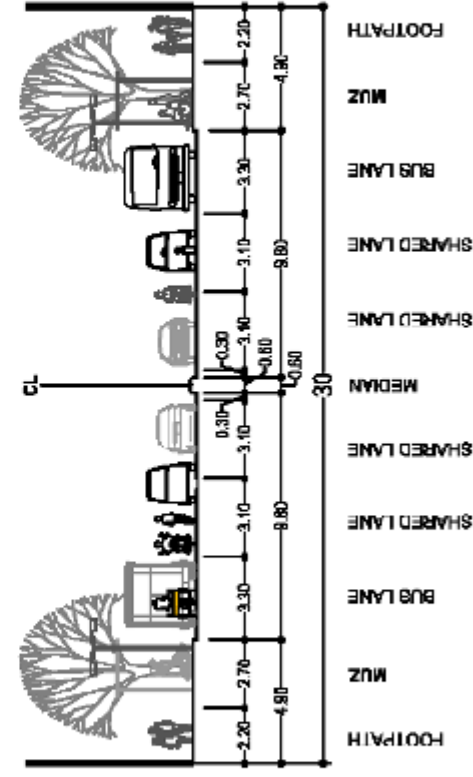

NOTE: Non-motorized lanes/ Cycle Tracks are OPTIONAL on R/Ws below 40m Width. In case smoother flow of motorized traffic is desired, one "Shared Lane" may be replaced by a dedicated Non-motorized Lane; to reduce *friction between slow and fast moving vehicles*.

30 M Primary Collector Road – Functioning as Arterial

IRC CROSS SECTION - 30 M COLLECTOR STREET
(4 LANE DIVIDED)

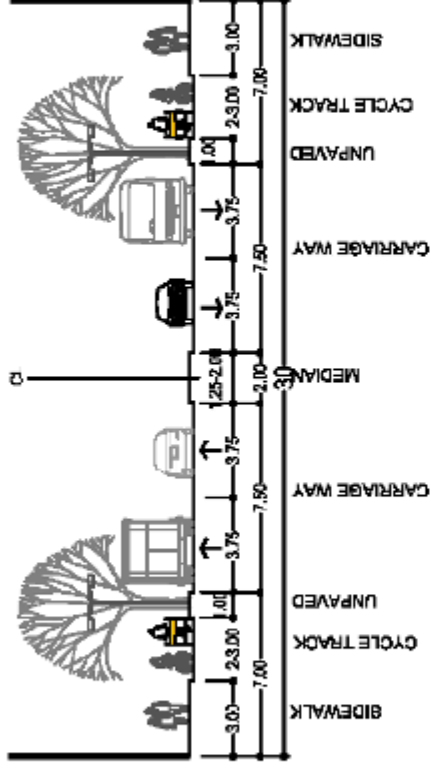

ii) 30 M ROAD WITH SEGREGATED TRAFFIC (Design Speed > 20km/hr)
Arterial Road Function

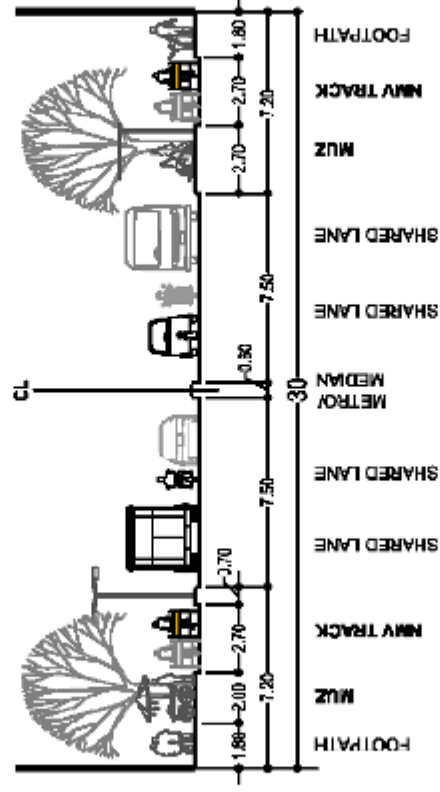

UTTIPEC CROSS SECTION - 30 M ROAD WITH MUZ & METRO
Arterial Road Function

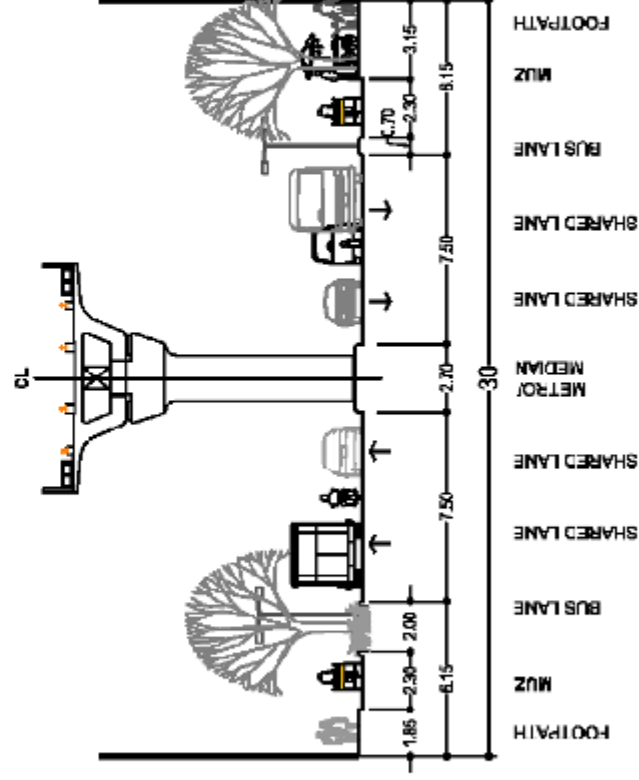

18-24 M Secondary Collector Road

IRC COLLECTOR STREET (2 LANE)

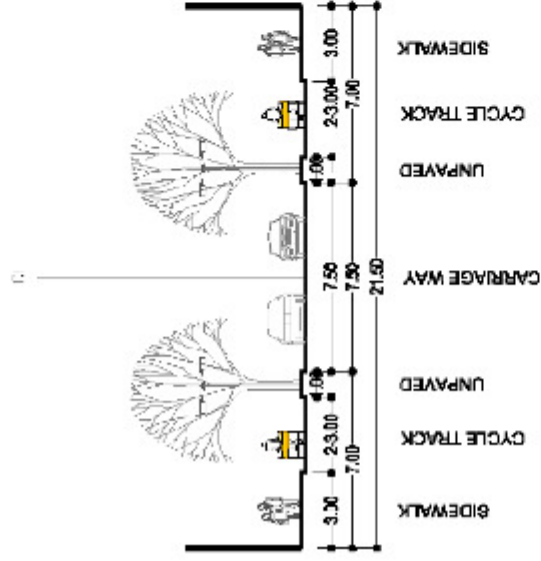

IRC COLLECTOR STREET (2 LANE)

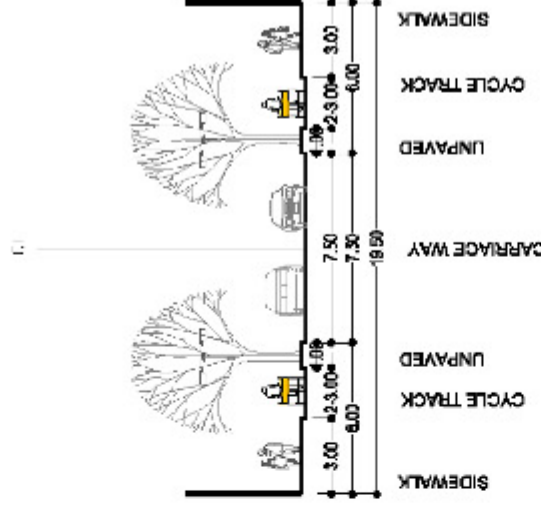

UTTIPEC 24 M ROAD WITH MUZ

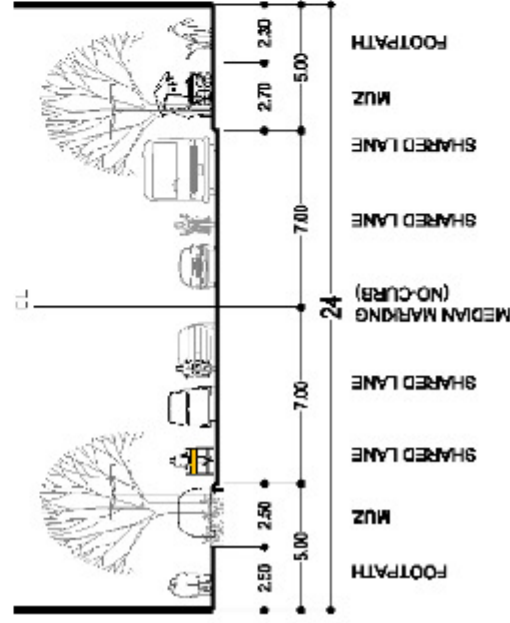

UTTIPEC 18 M ROAD WITH MUZ

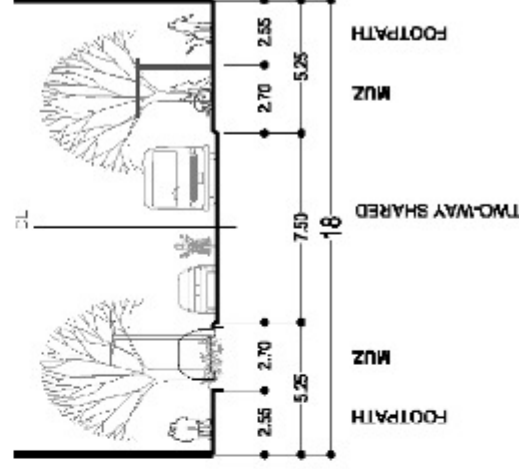

5. Design Toolkit: Mandatory Components



The Three Pavement Zones

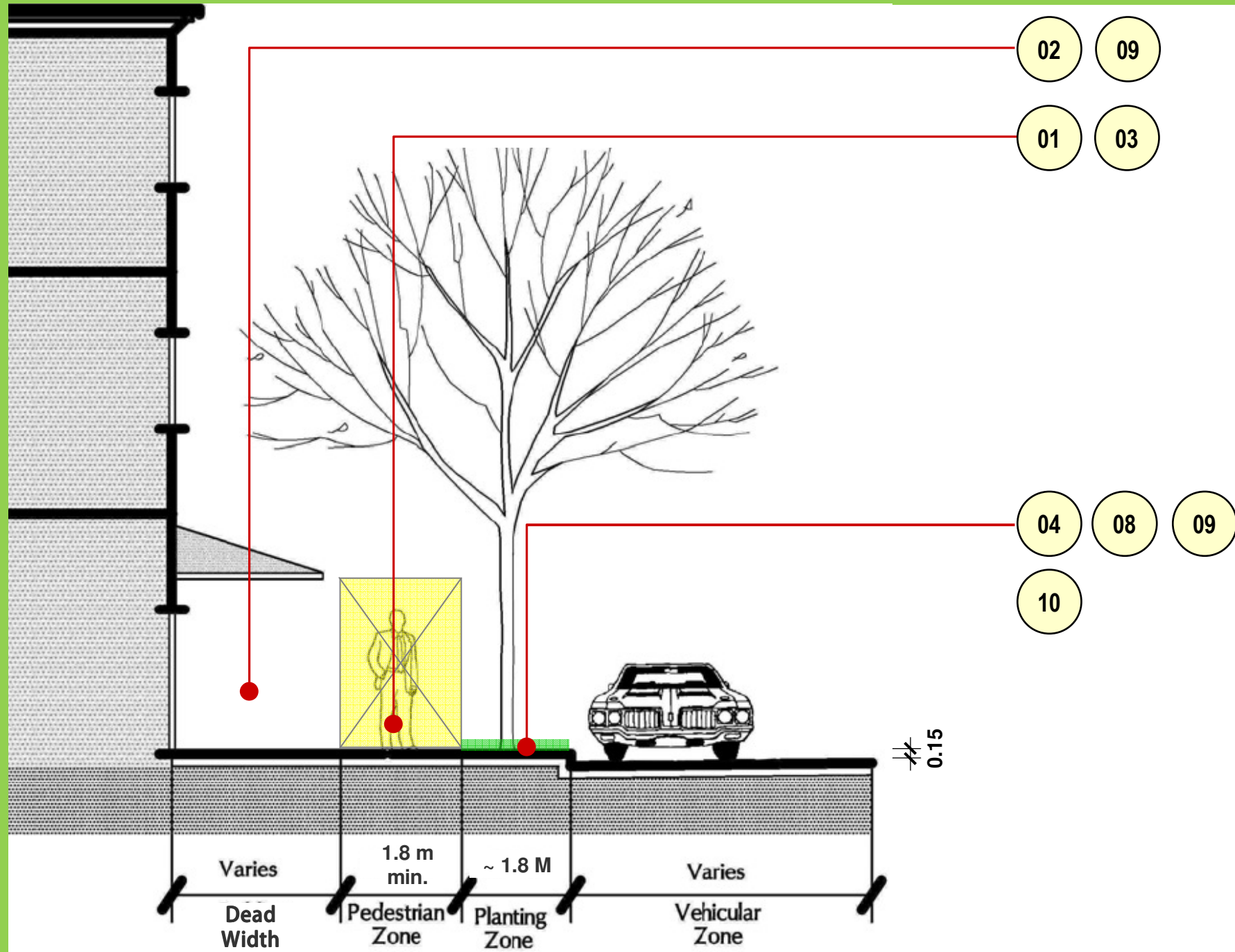

*Base Graphic Source: Streetscape Design Guidelines for City of Lancaster Pennsylvania

Not Acceptable



Delhi

NO clear walkway = Confusion Zone



Delhi

Tree branches on walkway

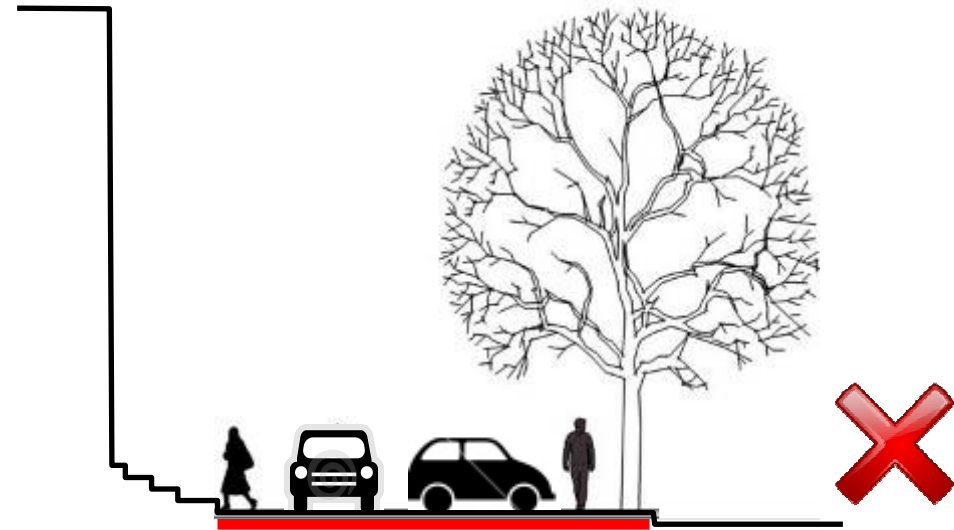

Commercial:

**Confusion Zone –
Severe car-pedestrian conflict**

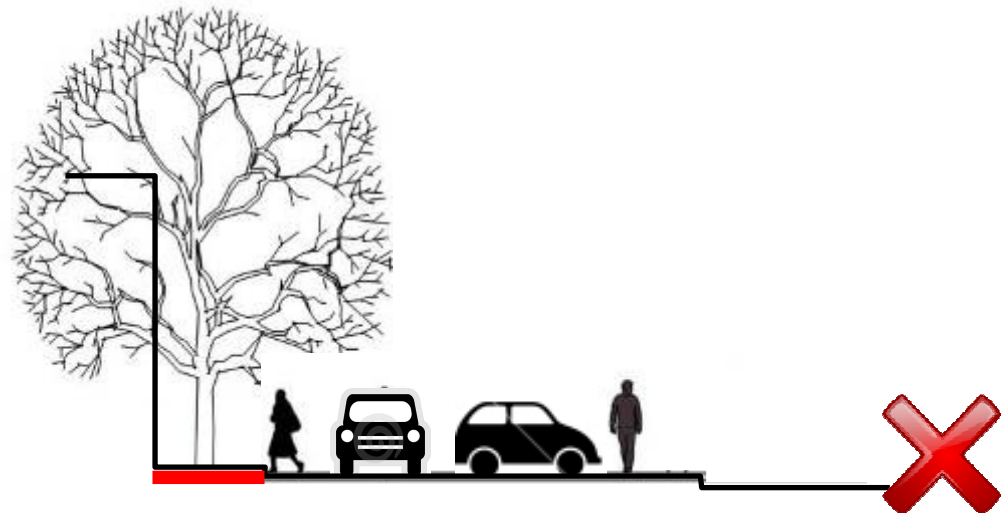

Residential:

**Tree planted in
walking zone!**

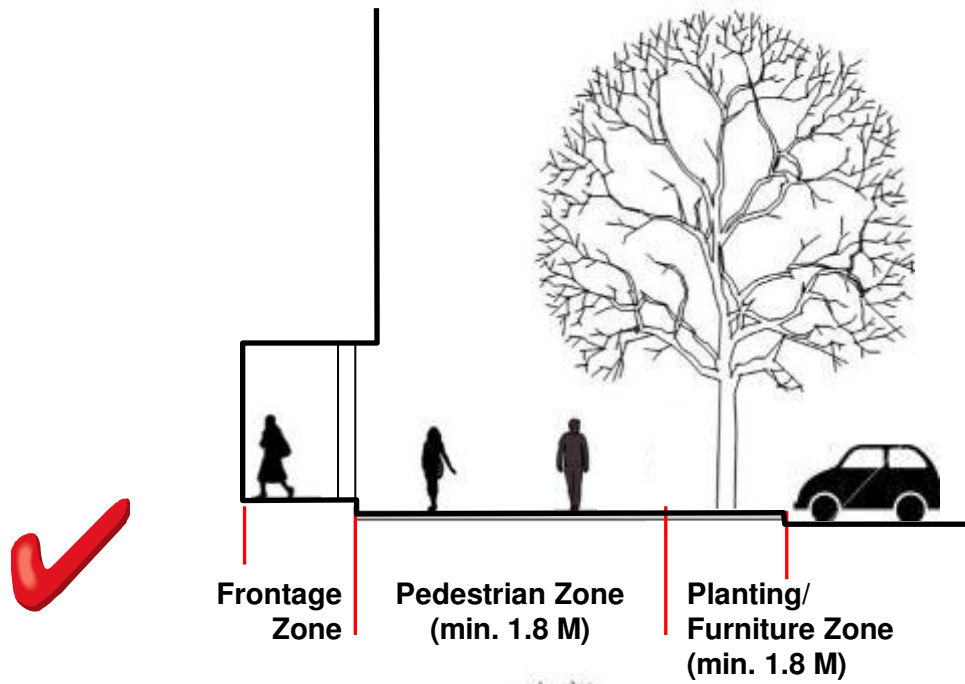

Commercial:



New Delhi

Frontage Zone

Pedestrian Zone

Planting/Furniture Zone

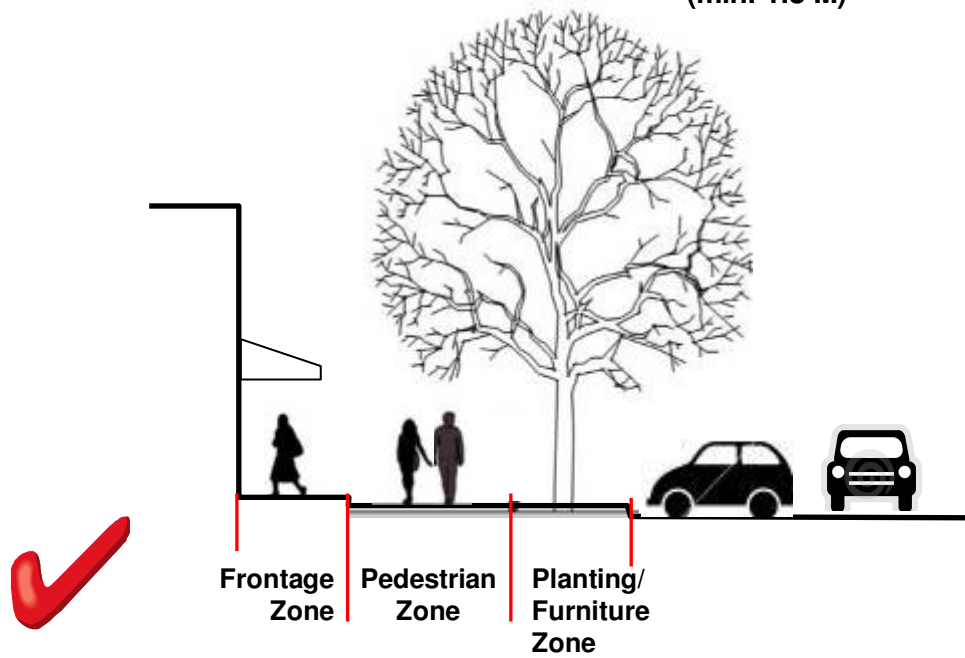

Residential:

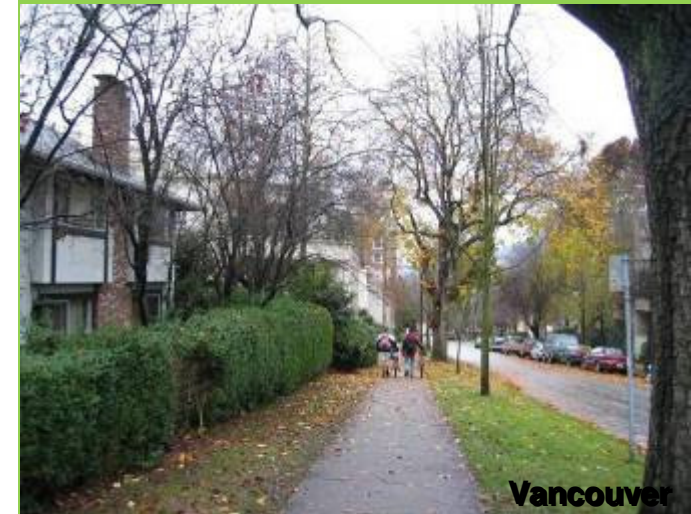

Vancouver

Frontage Zone

Pedestrian Zone

Planting/Furniture Zone

01 Pedestrian Only Zone

- 01A Clear Walking Zone
- 01B Walking Zone Width
- 01C Maximum Kerb Height
- 01D Kerb Radius and Slip Road Treatment
- 01E Continuous Pavement
- 01F = See 12 C
High Albedo Materials
- 01G = See 12D
Permeable Pavement



The Pedestrian Zone is the primary component of every street in a city. It is not only a zone to ensure smooth, comfortable, conflict free movement of pedestrians and public transport users, but also an area which shapes social interactions, safety and quality of life of people in a city.

MAIN PRINCIPLES:

Mobility

- An Obstruction free, safe, comfortable and continuous walking zone must be ensured for pedestrians on all roads of the city.

Ecology:

- Usage of Pervious Paving to build Natural Drainage Systems
- Reduce Heat Island Effect by increasing paving reflectivity

Safety/Comfort

- Provide accessibility ramps and tactile paving for the Handicapped
- Continuous and uniform walking area
- Trees and high-albedo materials to ensure optimal climatic comfort.

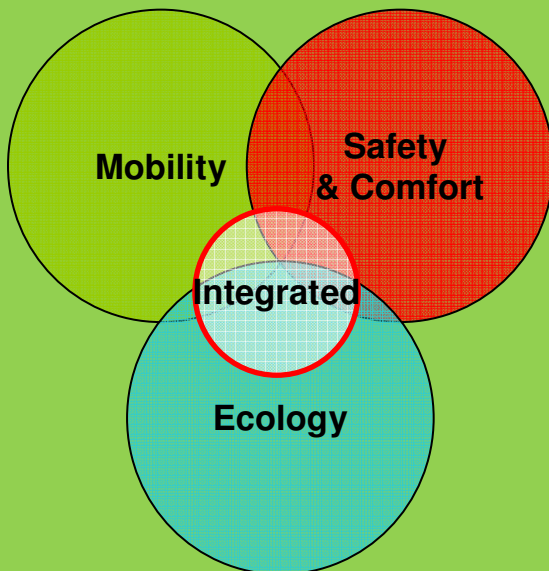

Not Preferable



01A Clear Walking Zone

Key Design Standards:



Obstruction Free Min. Walking Zone shall be 1.8 M X 2.4 M – both horizontally & vertically.

NO utility ducts, utility poles, electric, water or telecom boxes, trees, signage or any kind of obstruction should be placed within the "Walking Zone" in future.

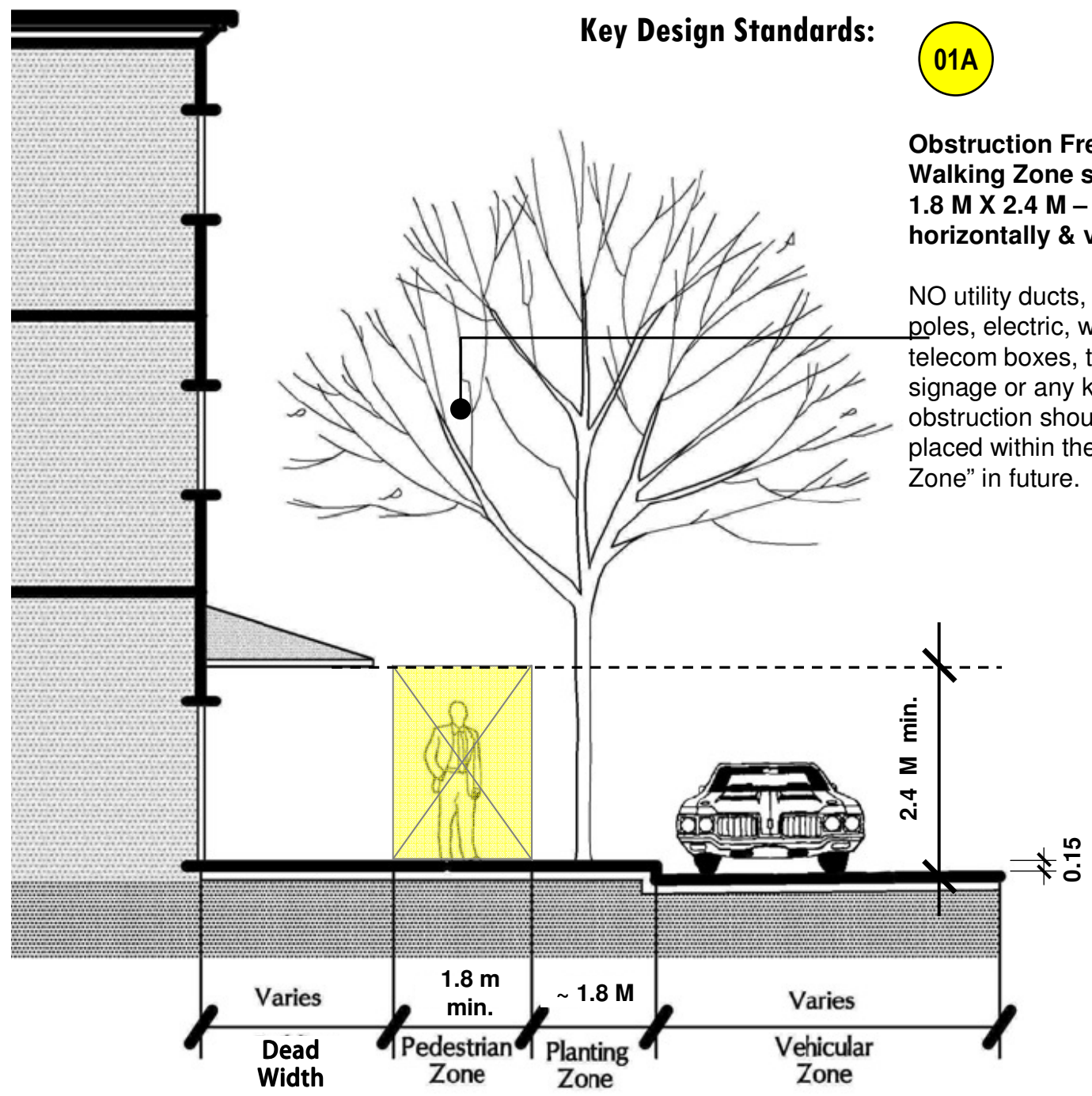



Portland

Extra walkway space through tree grates Effective walkway Dead Width

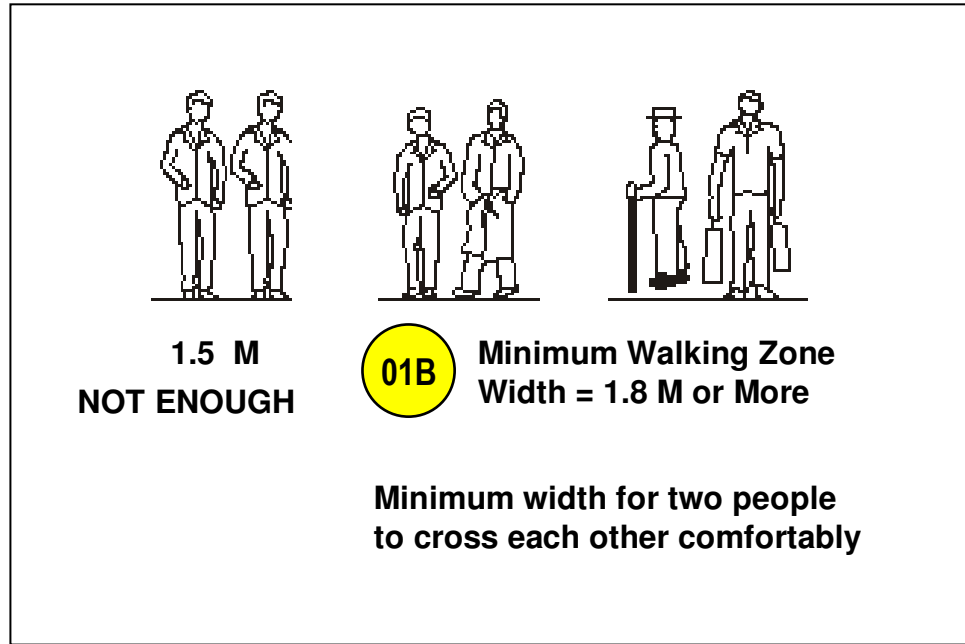

New Delhi

Dead Width Pedestrian Zone Planting/ Furniture Zone

Since the pedestrian flow is determined by land use, the following sidewalk widths can be applied:

- Residential Areas: 1.80 M (minimum)
- Commercial/ Mixed Use Areas: 2.50 M
- Commercial Nodes: 4.00 M

In addition to the above, a requisite “dead width” is to be added to all pedestrian zones, as per IRC Standards in Section 02.

O1C - Maximum Kerb* Height

Best Practices

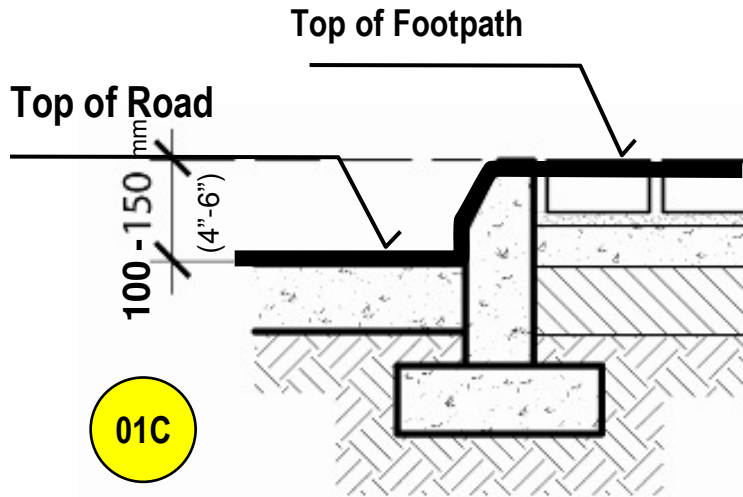

- Maximum height of a pavement (including kerb, walking surface, top-of-paving) shall not exceed 150 MM (6"). 100 mm (4") kerb height is preferable for Arterial Roads.
- All walking surfaces should be very rough/ matt-finish/ anti-skid.
- Medians should be maximum 150mm high or be replaced by crash barriers.
- In case the carriageway finished level is expected to rise during future re-carpeting, reduction in footpath level to 100 mm or less is acceptable. But under no circumstances is the height of footpath to exceed 150 mm.
- Finished top level and kerb height for all bus-stops to be 150 mm.
- Only along Segregated Busways/ BRT corridors, the kerb height of the Bus Stop could match the height of the bus floor.

Footpath kerbs should be the following type:

•Semi-mountable (150 mm high) where traffic volumes are high and efficiency of kerb-side lane is to be maximized. NOTE: In areas where the MUZ is present, the kerb height applies to the edge of MUZ. Footpath height in such cases could range from 0-150mm.

•Barrier type (150 mm high) where pedestrian volumes are high and traffic volumes and speeds are less (<25 km/hr) – so as to discourage vehicles from encroaching upon footpath space. The barrier kerb will decrease the efficiency of the left-most traffic lane.

On roads of design speeds 25-50 km/hr - protection of Pedestrians and NMV, can be ensured by treating the MUZ with fences, hedge-planting or bollards, wherever required. This also helps prevent jay-walking.

On roads of design speeds < 25 km/hr, jay-walking is acceptable so no physical barriers should be installed. Kerbless streets are recommended in heavy pedestrian areas.

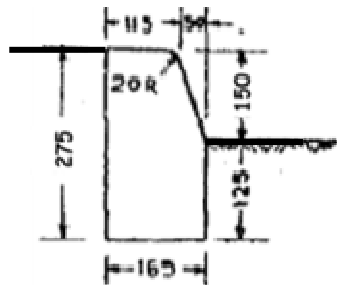

(a) Barrier type

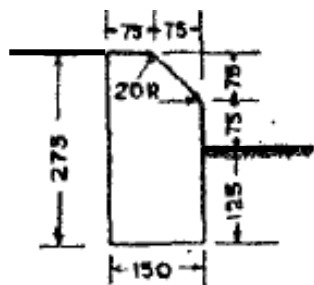

(b) Semi-barrier type

Graphics Source: IRC (modified)



1. Kerb heights on all roads to be Maximum 150 MM. On Arterial Roads, 100 MM is preferable.
2. In case of arterial roads where safety of pedestrians and cyclists is high-priority, the MUZ can be treated with hedge-planting or fencing or bollards, wherever required, to prevent jay-walking. Such barriers would also prevent motorized vehicles from encroaching upon footpaths and cycle tracks.

The above recommendations were approved by the Governing Body of UTTIPEC on the meeting dated 04.03.2011. Minutes are available on the UTTIPEC Website.



Non-Signalized Slip Roads i.e. “Free Left Turns” have made navigating the city a nightmare for pedestrians and cyclists.

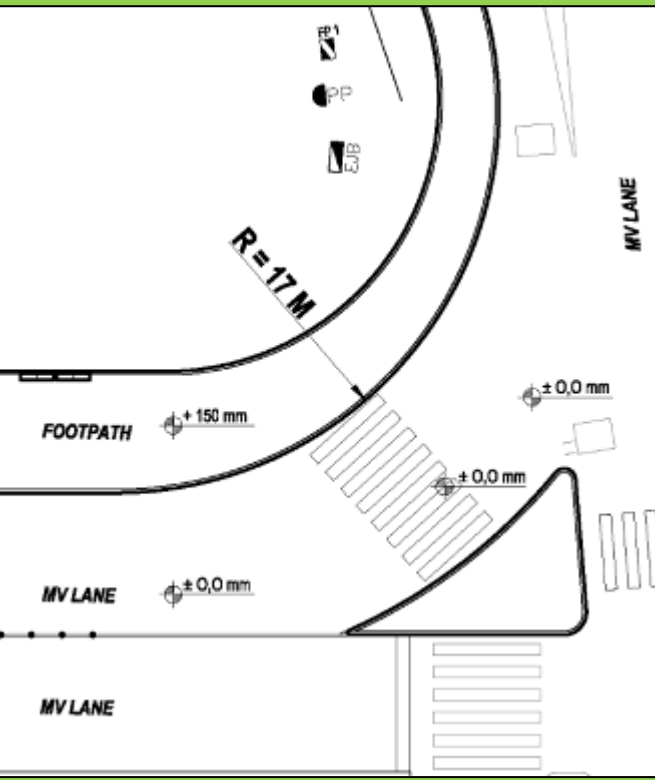

A Typical Slip road encourages speedy left turns and eliminates safety for pedestrians.

01D Kerb Radius and Slip Road Treatment

Corner Kerb Radii

Smaller turning radii increase pedestrian safety by shortening crossing distances, increasing pedestrian visibility for drivers, decreasing vehicle turning speed; and making drivers look out for pedestrians while taking the turn.

Essential Guidelines:

- **Maximum corner radius of Kerb = 12 M**
- **It may be reduced to 6 M in residential areas to slow down turning buses, trucks etc. with the provision of a corner mountable kerb for emergency vehicles.**

type of vehicle	length (m)	width (m)	height (m)	turning circle radius (m)
motorcycle	2.20	0.70	1.00 ²⁾	1.00
car				
- standard	4.70	1.75	1.50	5.75
- small	3.60	1.60	1.50	5.00
- large	5.00	1.90	1.50	6.00
truck				
- standard	6.00	2.10	2.20 ¹⁾	6.10
- 7.5t	7.00	2.50	2.40 ¹⁾	7.00
- 16 t	8.00	2.50	3.00 ¹⁾	8.00
- 22t (+16 t trailer)	10.00	2.50	3.00 ¹⁾	9.30
refuse collection vehicle				
- standard 2-axle vehicle (4 x 2)	7.64	2.50	3.30 ¹⁾	7.80
- standard 3-axle vehicle (6 x 2 or 6 x 4)	1.45	2.50	3.30 ¹⁾	9.25
fire engine	6.80	2.50	2.80 ¹⁾	9.25
furniture van (with trailer)	9.50 (18.00)	2.50	2.80 ¹⁾	9.25
standard bus I	11.00	2.50 ³⁾	2.95	10.25
standard bus II	11.40	2.50 ³⁾	3.05	11.00
standard vehicle - bus	11.00	2.50 ³⁾	2.95	11.20
standard vehicle - articulated bus	17.26	2.50 ³⁾	4.00	10.50-11.25
standard articulated truck	18.00	2.50 ⁴⁾	4.00	12.00 ⁵⁾
tractor		2.50 ⁴⁾	4.00	
trailer		2.50 ⁴⁾	4.00	
max. values of the road regulations				
2-axle vehicle (4 x 2)	12.00	2.50 ⁴⁾	4.00	12.00
vehicle with more than 2 axles	12.00	2.50 ⁴⁾	4.00	12.00
tractor with semi-trailer	15.00	2.50 ⁴⁾	4.00	12.00
articulated bus	18.00	2.50 ⁴⁾	4.00	12.00
trucks with trailer	18.00	2.50 ⁴⁾	4.00	12.00

notes:
¹⁾ height of driver's cab; ²⁾ total height with driver, about 2m; ³⁾ with wing mirrors, 2.95m; ⁴⁾ without wing mirrors; ⁵⁾ turning circle radius adjusted up to max. as per regulations

Slip Roads

Slip roads on Delhi roads are meant for the “signal free” movement of traffic, and to spare the left turning traffic from having to wait at traffic lights for taking a turn.

While such car-oriented design features has not really helped reduce congestion on city roads, this design feature makes “**crossing the street safely**” for pedestrians, cyclists, aged and physically challenged people an impossible task.

Making street-crossing unsafe for these road users further discourages walking and use of public transport, and therefore induces people to use private vehicles.

Therefore, from a pedestrian and cyclist safety standpoint, Slip roads are undesirable.

*Source: San Francisco Better Streets Plan – Policies and Guidelines for the Pedestrian Realm, June 2008

Street Kerb Corners and Slip Roads: Recommendations

Slip roads or Free Left Turns should be avoided. For intersections of R/Ws of 30m-30m or lesser, Slip Roads should be removed/ not considered. In cases where they already exist for intersections for intersection of 30m-45m and higher R/Ws, the following Strategies *may* be employed:

Option 1: Slip Road can be removed wherever Pedestrian and NMV volumes are high (01D-i).

Option 2: Reduce Corner Radius of kerb to calm traffic (01D-iii), and signalize the Slip road crossing (full or pelican signal), in order to make them safe for all users.

Option 3: Introduce raised table top crossings at slip roads and minimum 20-second pedestrians signals (01D-ii) – to allow pedestrians, cyclists and physically challenged people to cross the road comfortably at the same level.

Option 4: Signalized Turning Pockets (01D-iv) may be provided where left-turning volumes are high.

NOTE: For redevelopment of junctions of road intersections of 30-30m or 30m and above, the issue **MUST** be brought for discussion with all stakeholders at UTTIPEC before decision.

For intersections of roads 30m and less, Slip roads must be removed, corner kerb radii minimized and pedestrians/ full signals installed - to make the junctions safer.

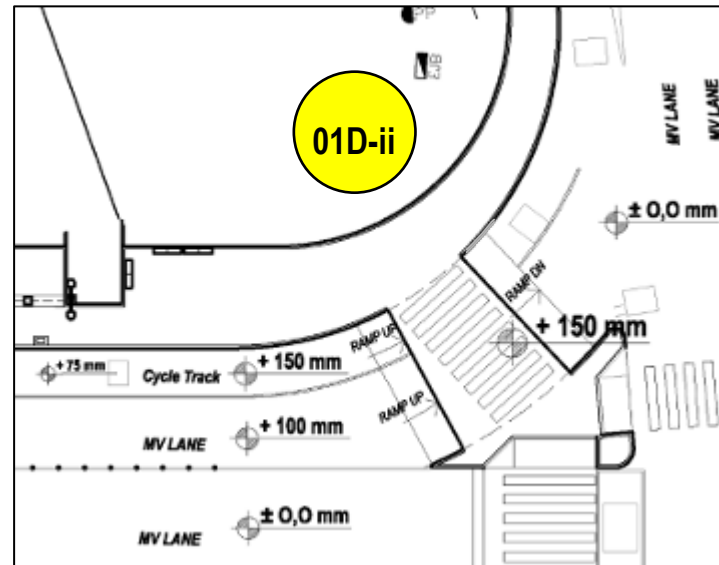
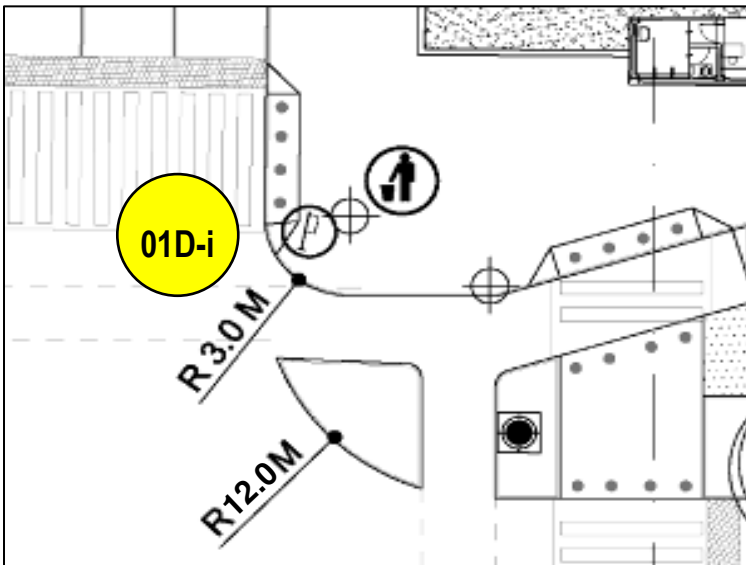

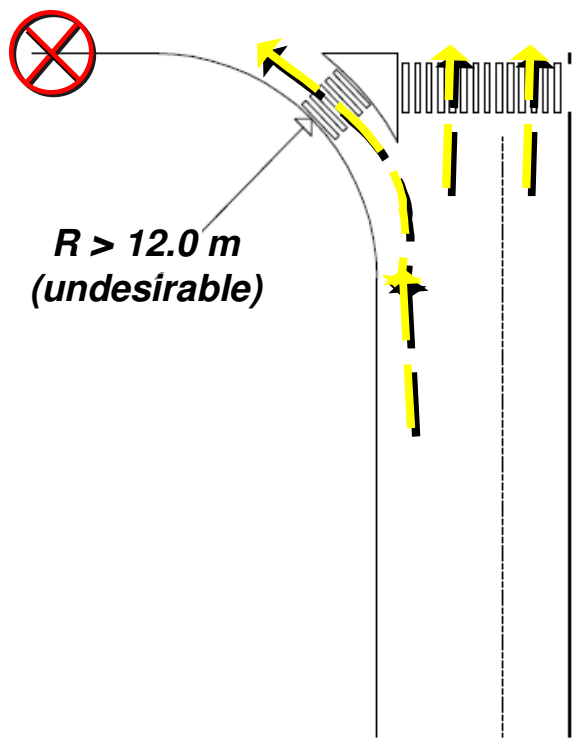

Current: Typical Delhi Road Intersection

Free left turns/ Signal-free slip roads make traffic turn corners at high speeds, making it unsafe for pedestrians and cyclists to cross.

Free left turns/ Signal-free slip roads have large turning radii which allows traffic to turn at high speeds and provide less visibility making it unsafe for pedestrians and cyclists to cross.

Slip roads may be replaced by Signalized "Left turning pockets" with much smaller corner kerb radii – that ensure Safe, Signalized Pedestrian crossings at junctions.

01D-iii

The maximum turning radius "r" allowed in the modified intersection design is 12 m; with recommended 3.0m for most intersections, especially for R/W less than 30m.

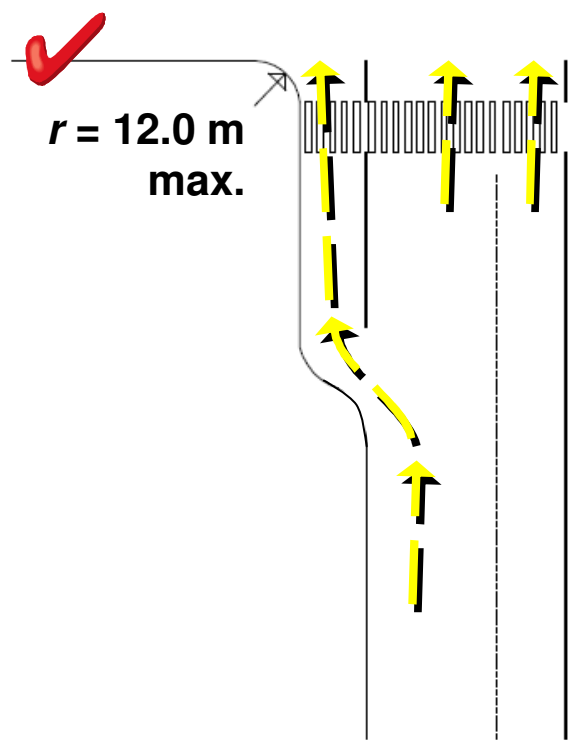

Proposed: Modified Intersection Design

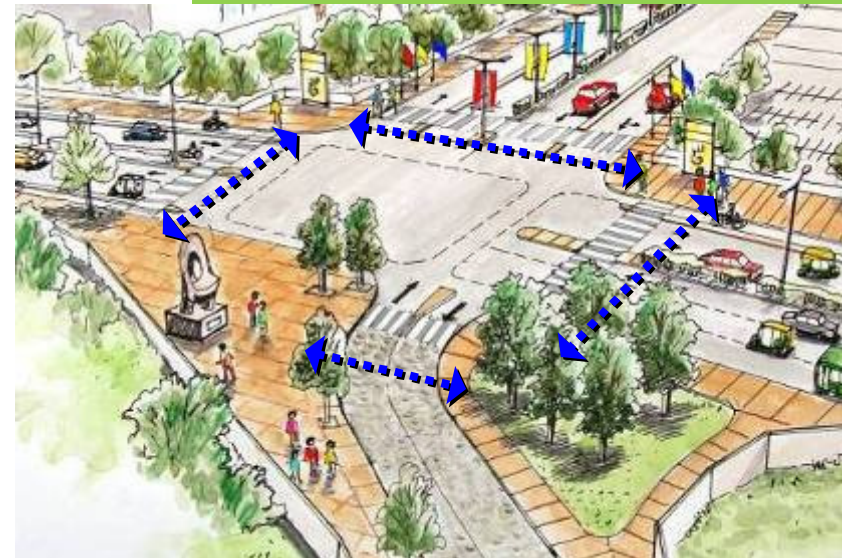
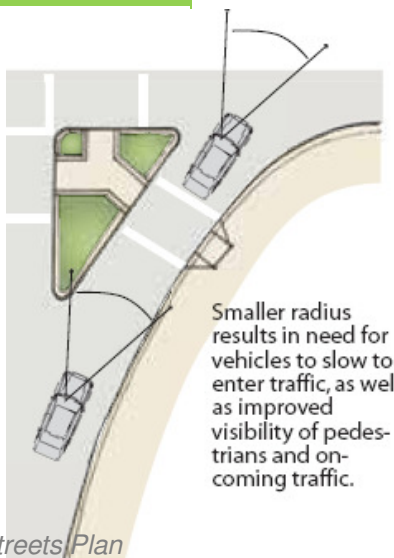

Free or Signalized Slip Road

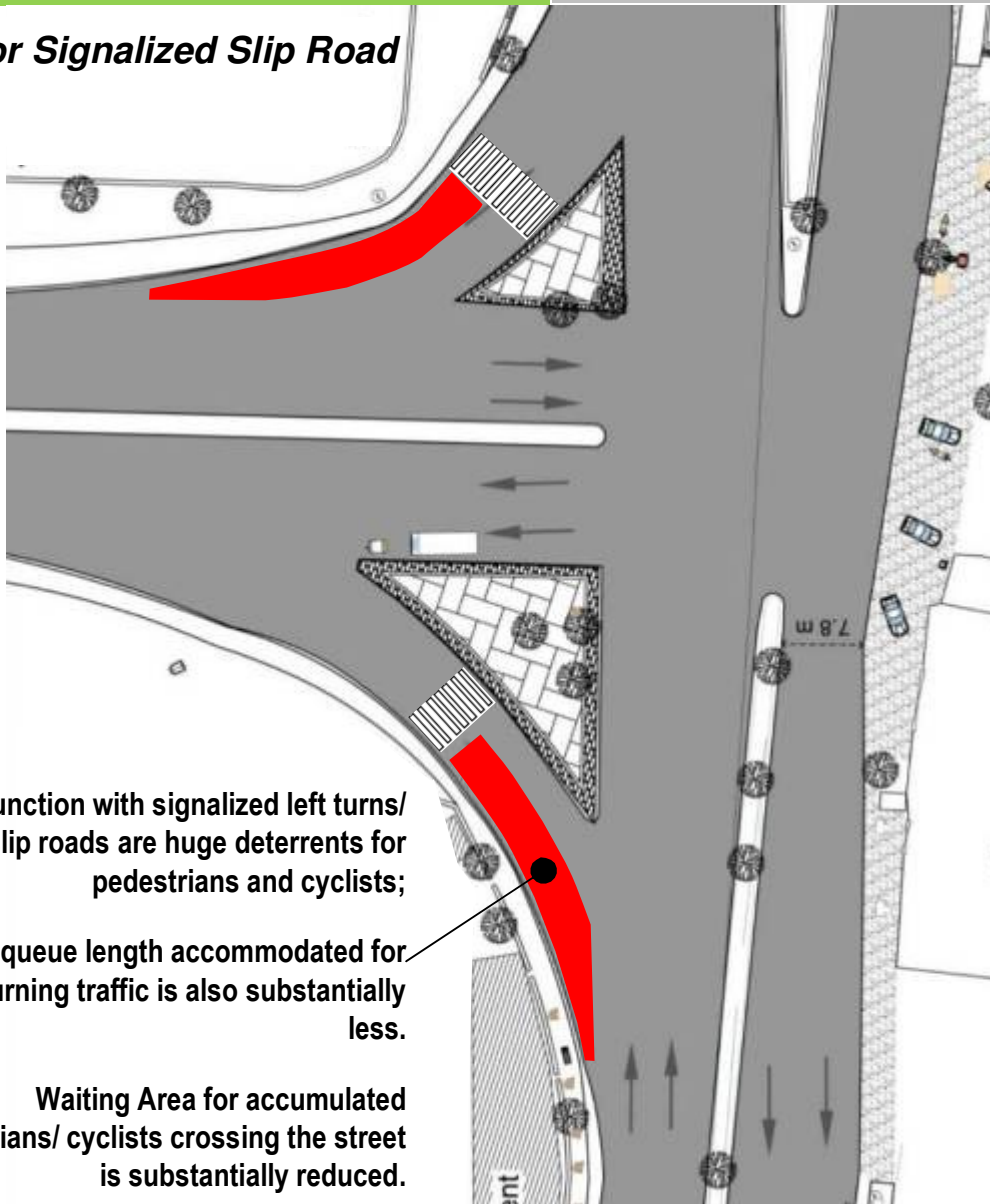

Road junction with signalized left turns/slip roads are huge deterrents for pedestrians and cyclists;

The queue length accommodated for left-turning traffic is also substantially less.

Waiting Area for accumulated pedestrians/ cyclists crossing the street is substantially reduced.

Turning traffic crates major obstruction and danger for straight moving cyclists/ rickshaws.

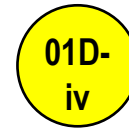

Signalized left turning pocket

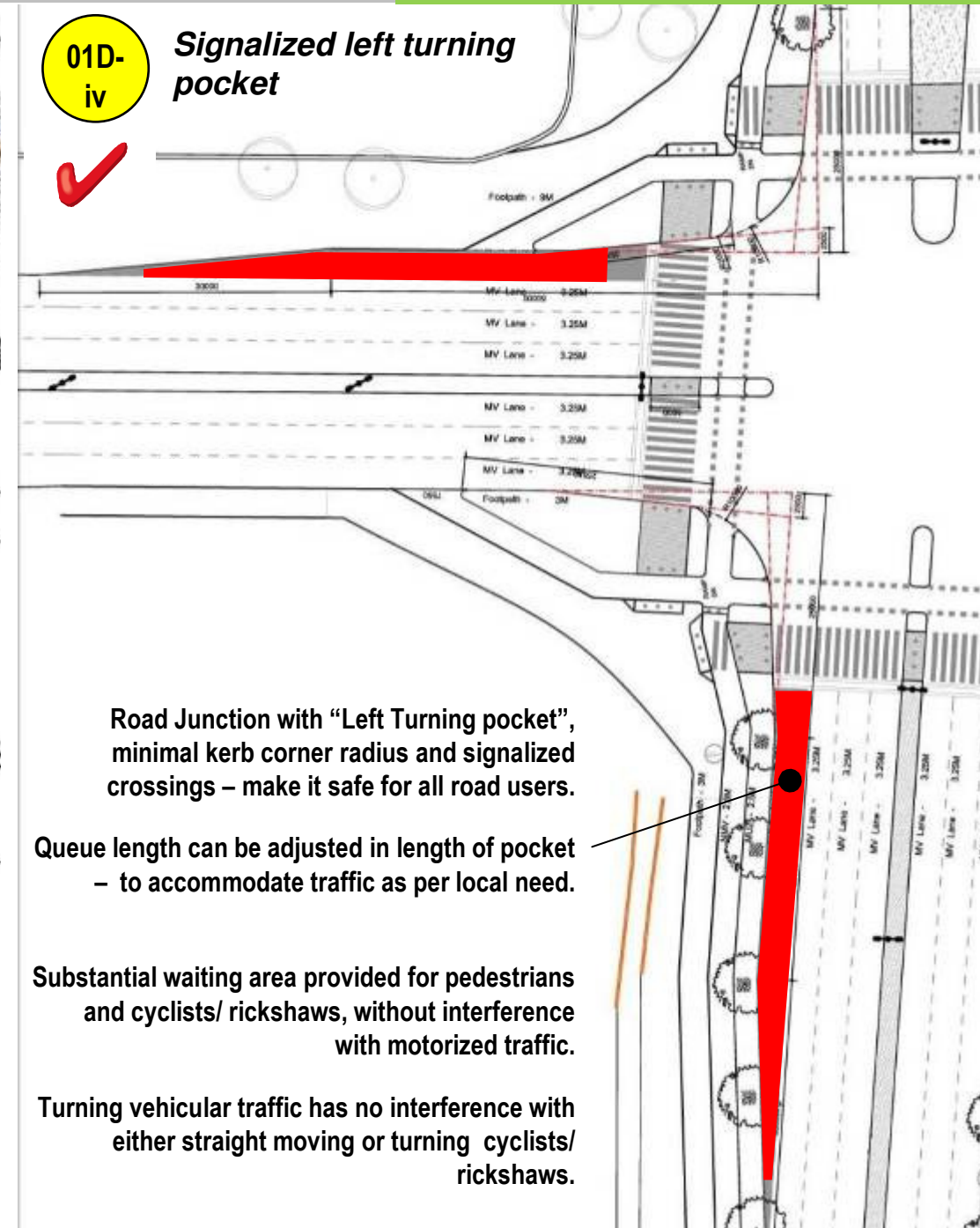

Road Junction with “Left Turning pocket”, minimal kerb corner radius and signalized crossings – make it safe for all road users.

Queue length can be adjusted in length of pocket – to accommodate traffic as per local need.

Substantial waiting area provided for pedestrians and cyclists/ rickshaws, without interference with motorized traffic.

Turning vehicular traffic has no interference with either straight moving or turning cyclists/ rickshaws.

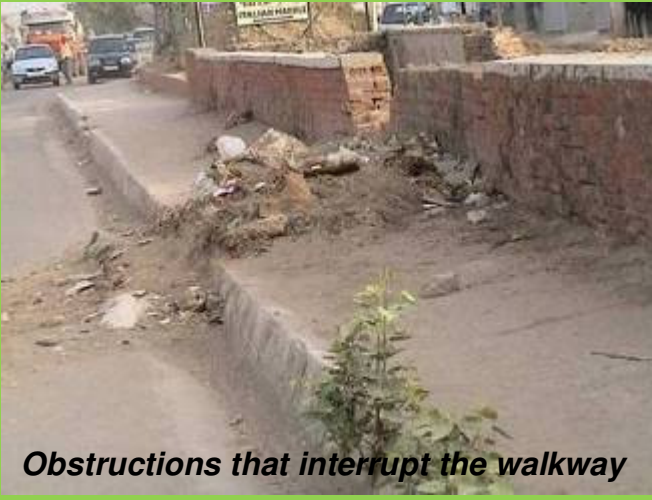

Obstructions that interrupt the walkway



Uneven pavement surface due to lack of proper setting in a concrete sub-base.



Dramatic changes of elevation

Sidewalks and Cycle Lanes should be regarded as a transportation system which is connected and continuous, just like roadways and railways.

Key Design Guidelines:

- Avoid sidewalk interruptions by **minimizing kerb cuts** i.e. Minimize the number of driveways that cross the sidewalk – in order to support pedestrian safety and a continuous sidewalk.
- Maintain an **even surface and elevation** of the pavement at 150 MM or less from surrounding road level.
- At entry points of properties – introduce “**raised driveway**” or “**table-top**” details – where pedestrian and cycle tracks continue at their same level, but the motorized vehicles have to move over a gentle ramp to enter the property.
- Remove all obstructions from the sidewalks.
- **Consistency of design elements, color and texture, help provide visual continuity and calm traffic, even at crossings.**

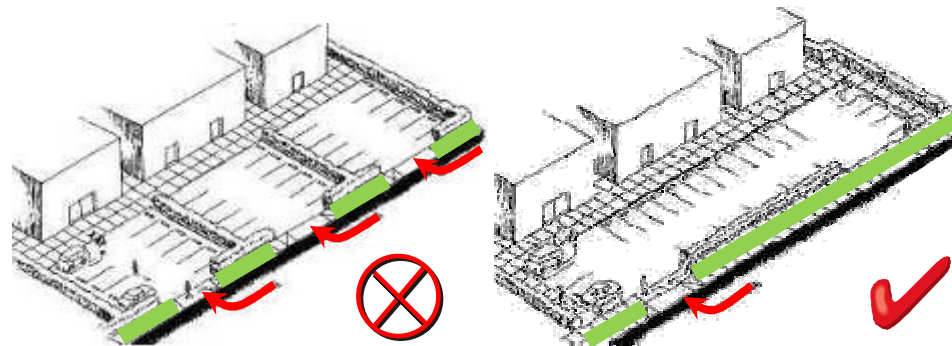

Source: FHWA Course on Bicycle and Pedestrian Transportation, 2006



01E Continuous Pavement

Best Practices

01E

At entry points of properties – introduce “raised driveway” or “table-top” details – where pedestrian and cycle tracks continue at their same level, but the motorized vehicles have to move over a gentle ramp to enter the property.

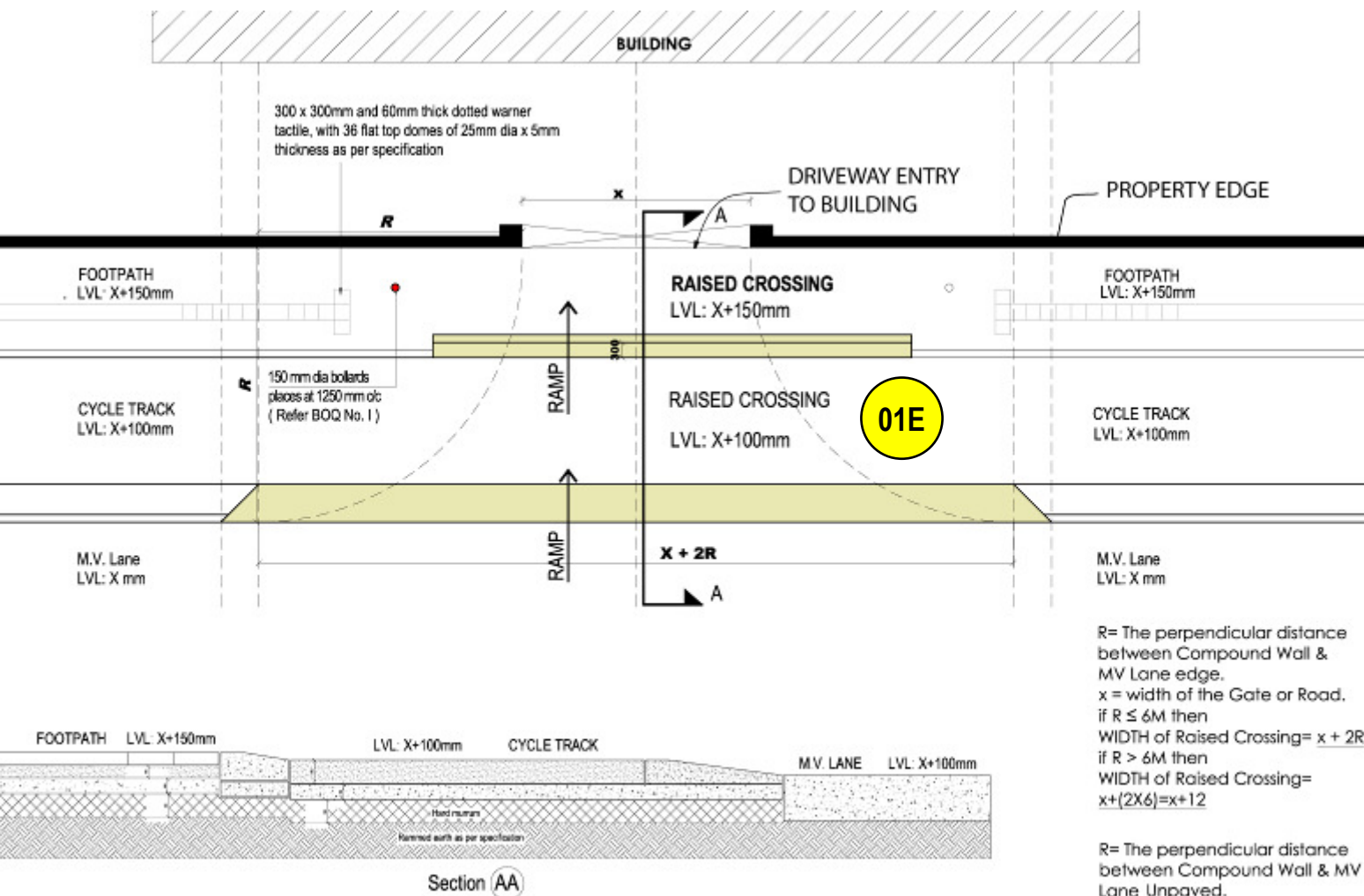

Typical Detail of Raised Driveway at Building Entries.

Source: TRIPP, IIT Delhi, BRT Design Specifications, 2009

R= The perpendicular distance between Compound Wall & MV Lane edge.
 x = width of the Gate or Road.
 if $R \leq 6M$ then
 WIDTH of Raised Crossing= $x + 2R$
 if $R > 6M$ then
 WIDTH of Raised Crossing= $x + (2 \times 6) = x + 12$

R= The perpendicular distance between Compound Wall & MV Lane Unpaved.
 $x = 4.50M$
 $R = 5.20M$
 WIDTH of Raised Crossing= $x + 2R$
 $= 4.50 + 2 \times 5.20 = 14.90M$



BRT Corridor, New Delhi



02 'Dead Width'* or Frontage Zone

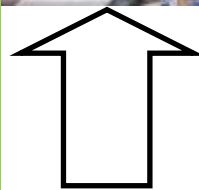
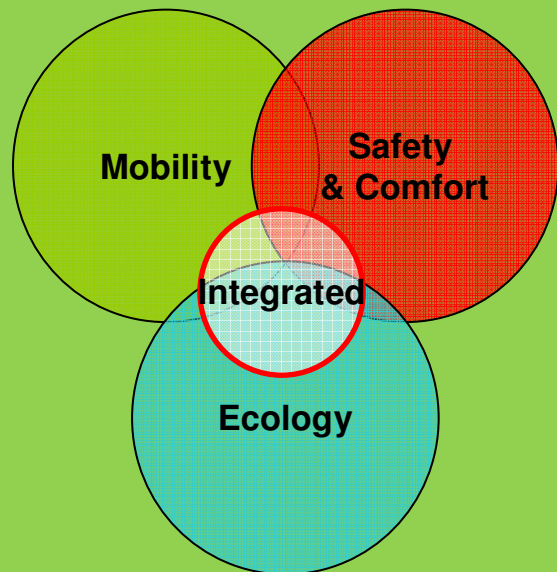

- **Attractive windows and hawkers in shopping districts, or entries and steps leading up to buildings - create momentary stoppages of curious pedestrians or users of the buildings.**
This is a desired element of a successful and active street.
- **These window watchers take up about 0.5 to 1.0 m of additional space, which must be provided in order to ensure conflict free movement of all pedestrians.**

*Source: IRC: 103 - 1988

Not Preferable



Above: No extra space allowed for pedestrians interested in stopping at attractions. Therefore stopping pedestrian disrupts moving pedestrian flow on sidewalk.

02 Dead Width

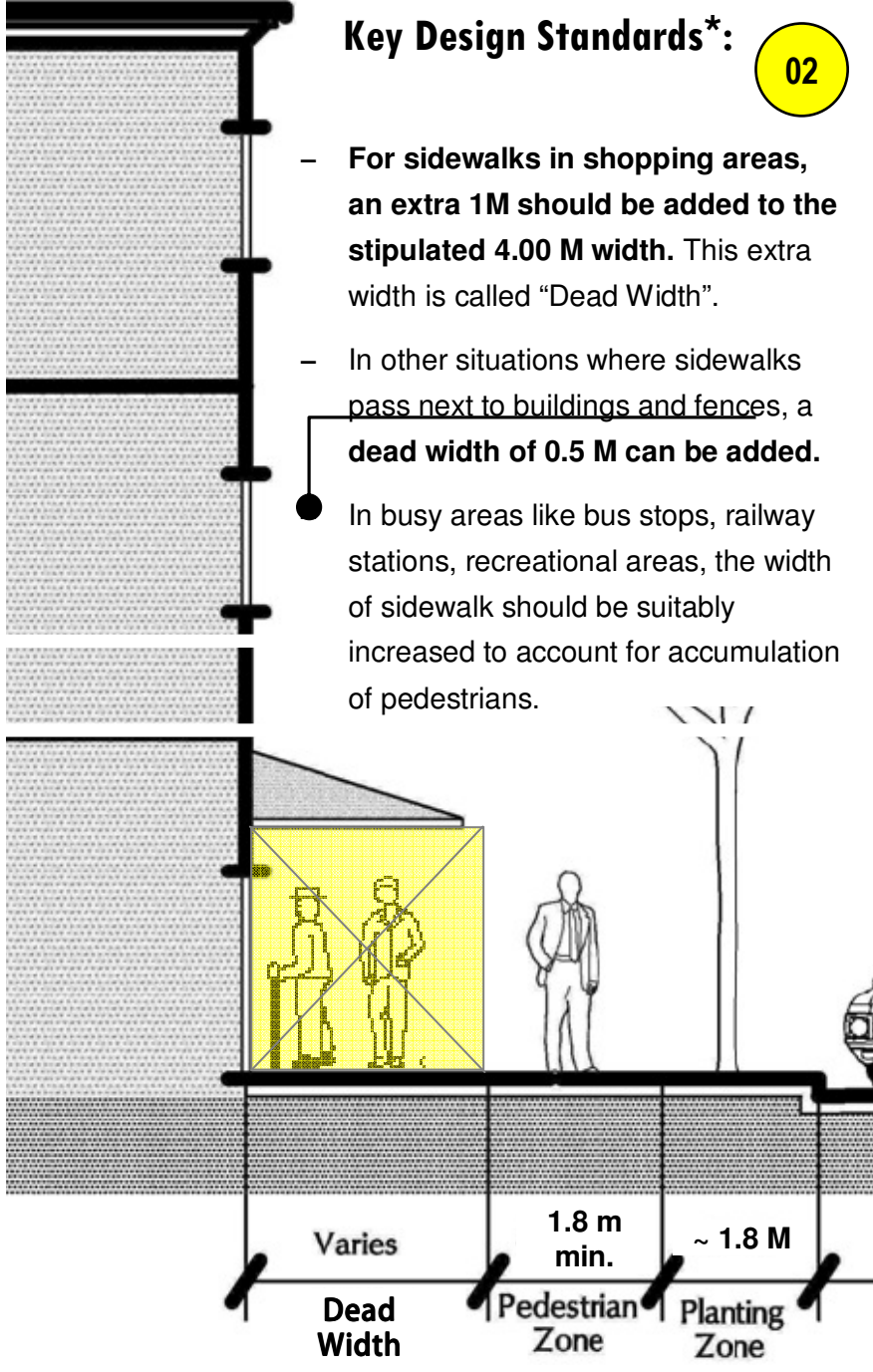

Best Practices

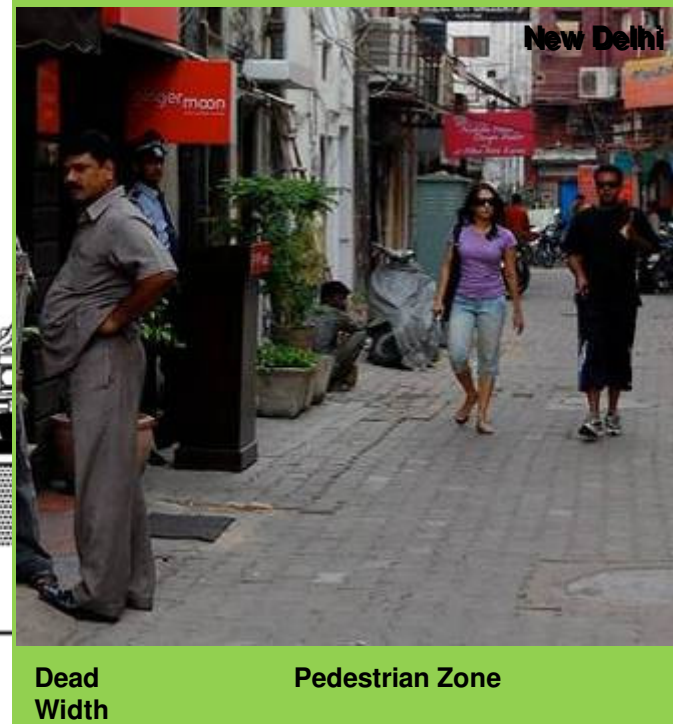
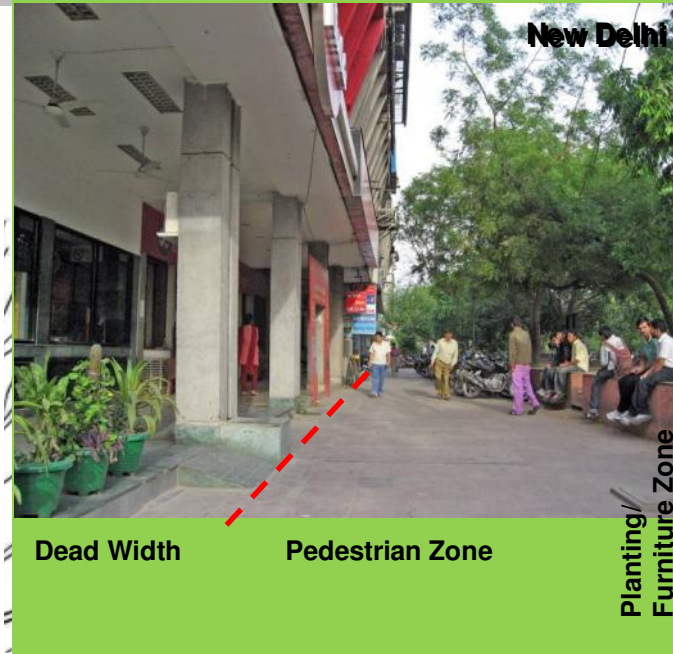

*Source: IRC: 103 - 1988

This page is intentionally left blank.

03 Universal Accessibility

- 03A Kerb Ramps
- 03B Raised Table-Top Crossings
- 03C Tactile Paving
- 03D Auditory Signals
- 03E Accessible Signage



Universal Accessibility is required for all sidewalks, crossings, parks, public spaces and amenities – for people using wheelchairs, strollers, walkers, crutches, handcarts, bicycles, aged people, visually or hearing impaired, and pedestrians with temporary mobility impairment or injury.

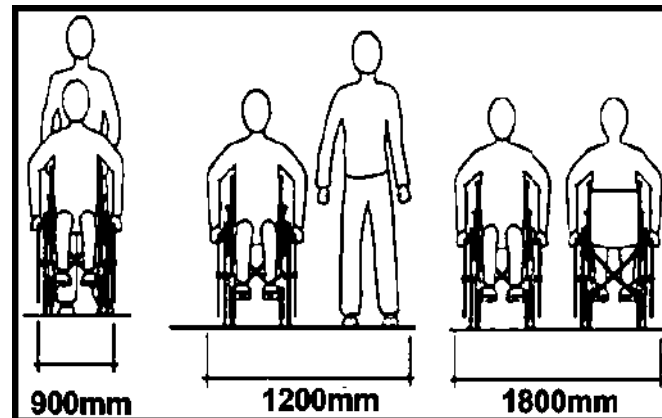
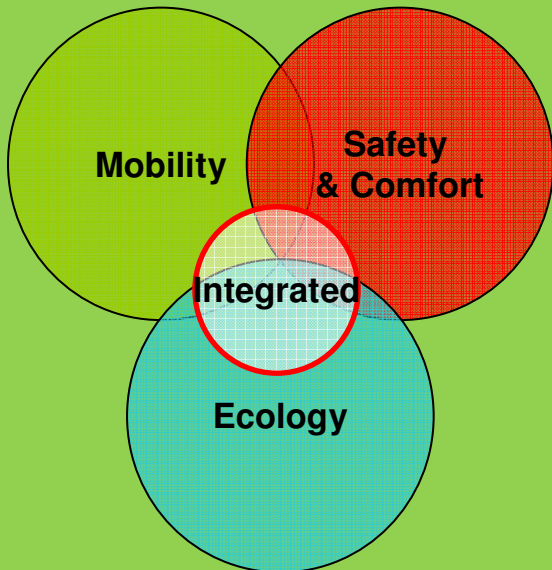
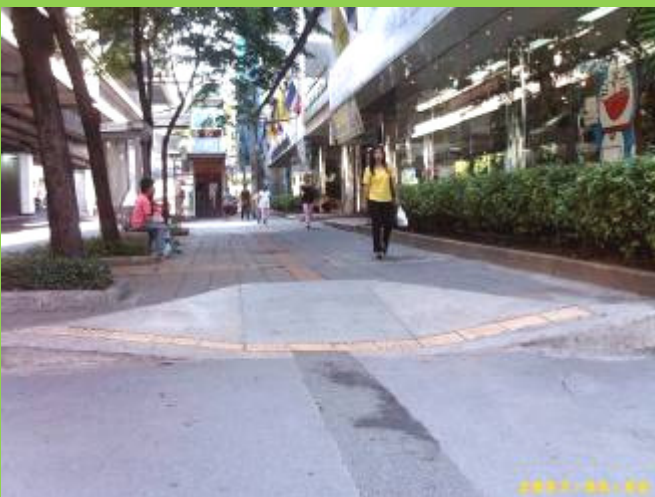
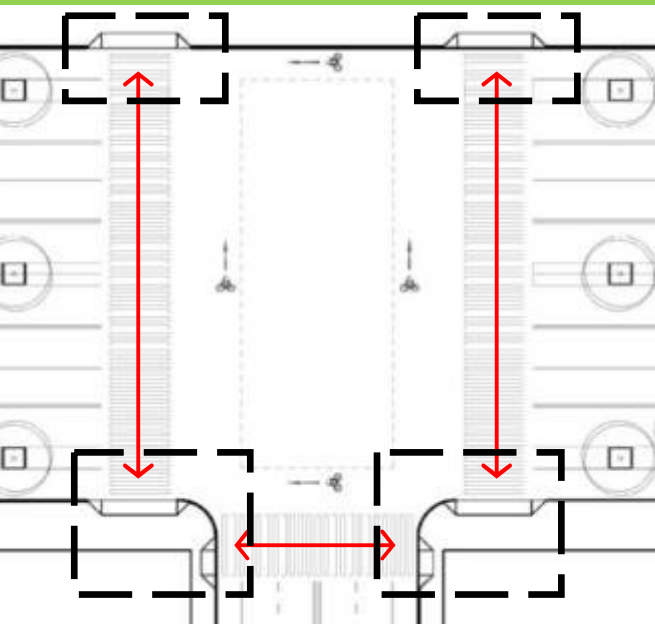

Diagram Source: Samarthyam, National Center for Accessible Environment, Research Report- Road Safety, 2008

03A Kerb Ramps*

Location of Kerb Ramps must align with the Zebra Crossing location and the location of Kerb-ramp on the opposite side.



Kerbed Ramp with Tactile Paving

Kerb ramps provide pedestrian access between the sidewalk and roadway for people using wheelchairs, strollers, walkers, crutches, handcarts, bicycles, and pedestrians who have trouble stepping up and down high kerbs. **The absence of kerb ramps prevents any of the above users from crossing streets.**

Kerb ramps must be installed at all intersections and mid-block locations where pedestrian crossings exist.

At Signalized Crossings: Use Kerb Cut- Ramps

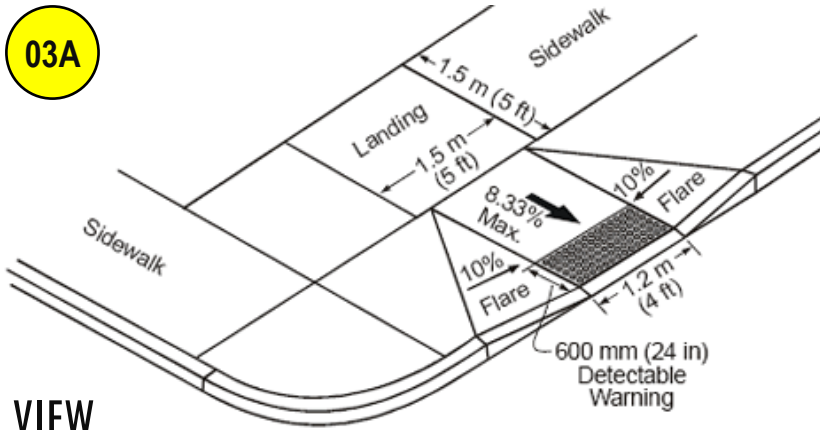

VIEW

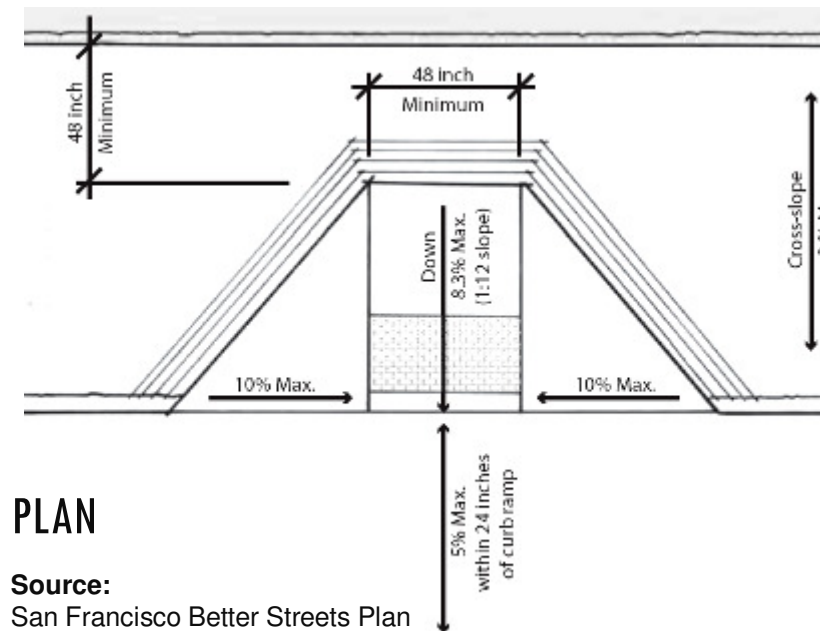

PLAN

Source:
San Francisco Better Streets Plan

Key Design Guidelines:

- Standard kerb ramps are cut back into the footpath (flush with roadway), at a gradient no greater than 1:12, with flared sides (1:10) providing transition in three directions.
- Width of the kerb ramp should not be less than 1.2 M.
- Tactile warning strip to be provided on the kerb side edge of the slope, so that persons with vision impairment do not accidentally walk onto the road.
- The ramps should be flared smooth into the street surface and checked periodically to make sure large gaps do not develop between the gutter and street surface.
- It is desirable to provide two kerb cuts per corner. Single ramp located in the center of a corner is less desirable. Separate ramps provide greater information to pedestrians with vision impairment in street crossings.
- Mid block crossings accessible for persons with disability should be provided for blocks longer than 250M.

Source: Guidelines for Inclusive Pedestrian Facilities, Report for IRC by Anjlee Agarwal, Samarthyam.org

03B Raised “Table-top” Crossing (See also 06B)

At Non-Signalized Crossings: Use Raised “Table-top” Crossings

Key Design Guidelines:

- Raised crossings bring the level of the roadway to that of the sidewalk, forcing vehicles to slow before passing over the crossing and enhancing the crossing by providing a level pedestrian path of travel from kerb to kerb. Cobble stone are not recommended on the top, but on the slopes.
- Raised Crossings also increase visibility of pedestrians and physically slow down traffic allowing pedestrians to cross safely.
- **Raised crossings should be located at:**
 - At Slip Roads (free left turns)
 - Where high-volume streets intersect with low-volume streets, such as at alley entrances, neighborhood residential streets, and service lanes of multi-way boulevards.
 - At Mid-Block Crossings

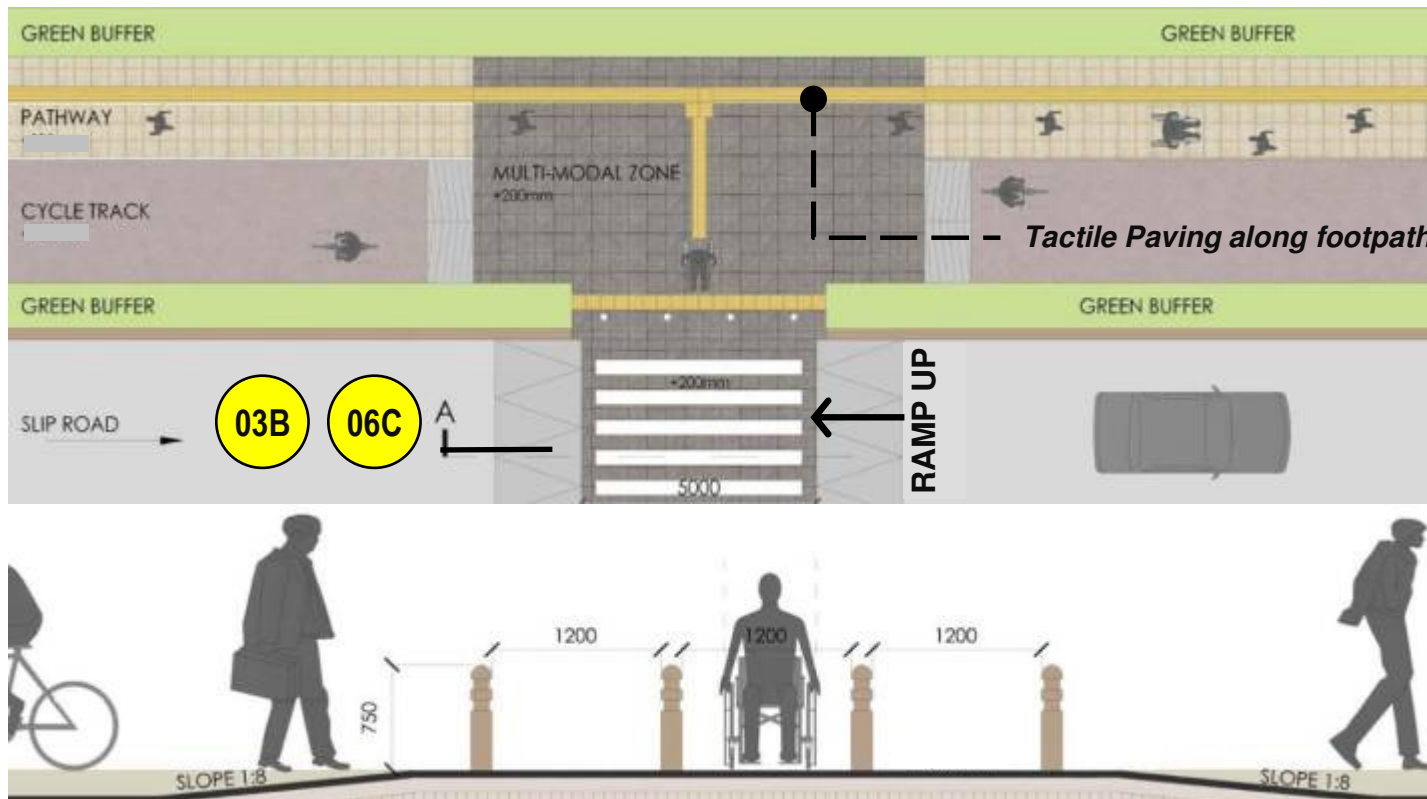

Sample Drawings Courtesy: Oasis Designs Inc.

Best Practices



Table-Top Crossing at Intersection, London



Bollard spacing shown here is too less...

Spacing between Bollards on a Kerb Ramp must be minimum of **900 MM** (3 feet).



Table top crossing at Intersection, Bogotá

03C Tactile Paving (See also 07A)



Tactile paving marking top & bottom of steps.



Accessible Bus Stop, Delhi



Tactile paving on footpath leading to ramp and crossing, BRT Corridor Delhi

Persons with vision impairment need guidance in using a pedestrianised area, especially if the footway crosses larger open spaces where the usual guidance given by the edge of the footway or building base is not available, or when pedestrians need guidance around obstacles.

A continuous tactile guide (guiding & warning tile) in the direction of pedestrian travel, which has a different texture to the rest of the footway, can provide this guidance.

Key Design Guidelines:

- A distance of 600-800mm to be maintained from the edge of footpath/ boundary wall/ any obstruction.
- A height of about 5mm for the raised part of the surface is sufficient for almost all persons with vision impairment to detect, without causing too much discomfort for other pedestrians.
- Tactile paving must be maintained to ensure that the profile does not erode away. **Vitrified non-glazed tactile pavers are preferable.**
- Tactile tiles should have a colour (preferably canary yellow), which contrasts with the surrounding surface.
- Tactile Paving should be **minimum 300mm wide** so that someone can't miss it by stepping over it.

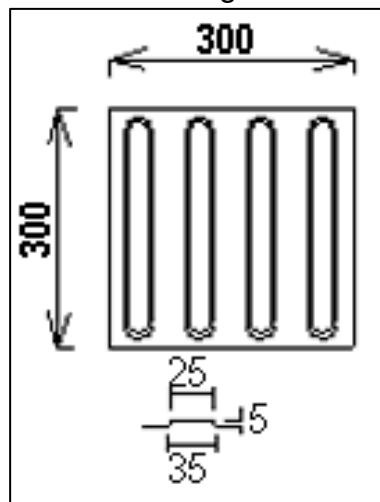

“Go” - Guiding Tile

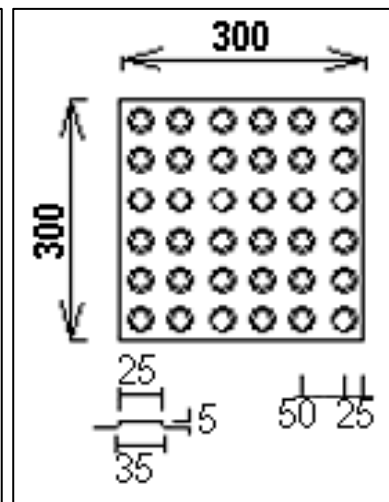

“Stop” - Warning Tile



Engineering configuration of floor tactile tiles

03C Tactile Paving (See also 07A)

Best Practices

Tactile pavers (Guiding and warning path) should be provided:

- To lead persons with vision impairments to the lifts, crossings, toilets, bus stops, i.e. all public and road facilities.
- In front of an area where traffic is present.
- In front of an entrance/exit to a facility like subway/FOB/ public utility.
- To and from a staircase or multi-level crossing facility.
- In open space to orient persons with vision impairment.

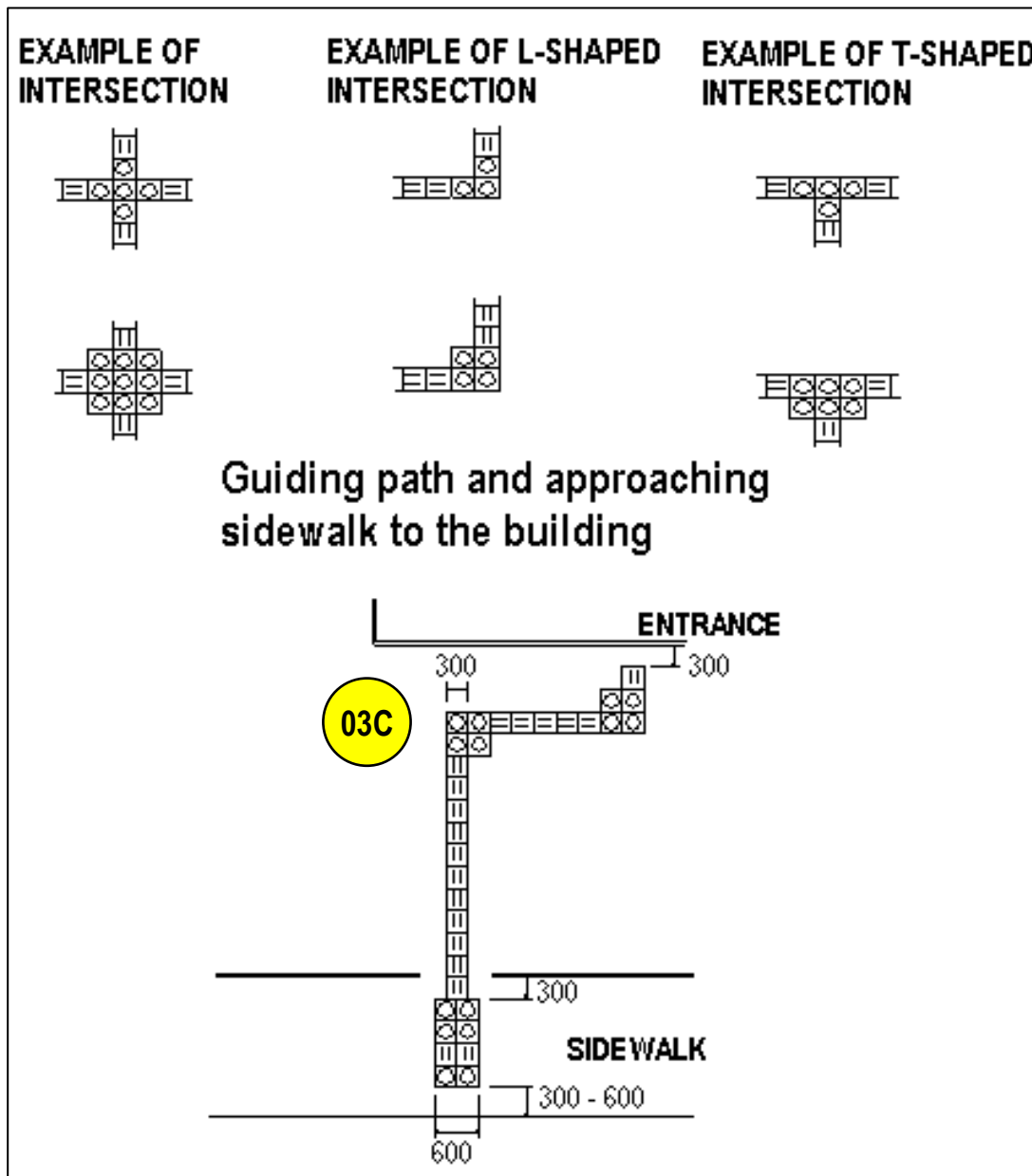

Source: CPWD Guidelines and Space Standards for Barrier Free Built Environment for Disabled and Elderly Persons 1998, Ministry of Urban Development



Tactile paving on footpath leading to ramp and crossing: BRT Corridor

Design specifications:

Ramp slope	8% maximum
Gutter slope	5% maximum
Flare slope	10% maximum
Lip at roadway	6mm maximum, flush surface
Ramp width	1200mm minimum, width of crossing
Landing width	1500mm
Cross fall on landing and approach	2% maximum
Width of tactile warning surface	610mm

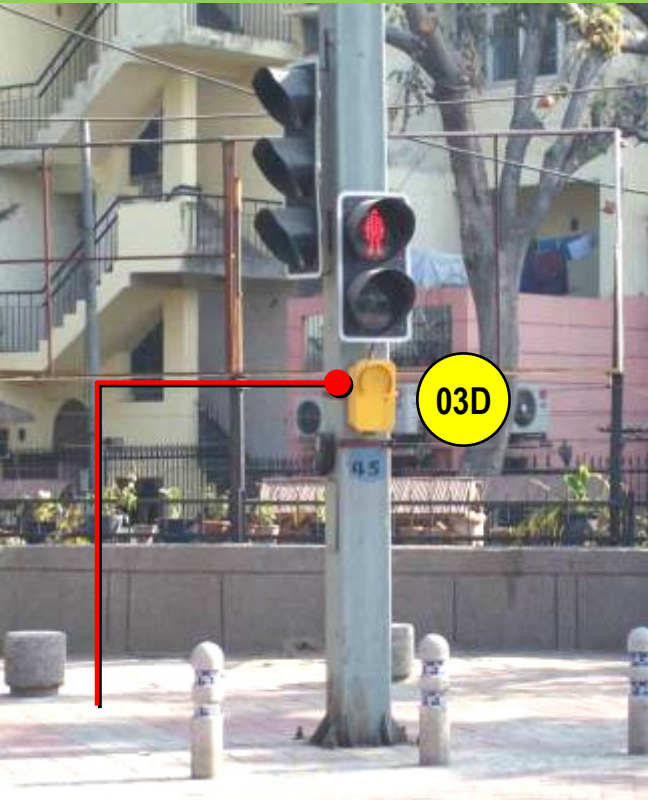

03D

Audible signals which beep when light is green (BRT Corridor, Delhi)



Accessible Bus Stop, Delhi

Key Design Guidelines:

- **Audible crossing signals (pelican crossings)** help everyone, as well as being essential for persons with vision impairments.
 - Pedestrian traffic lights should be provided with clearly audible signals to facilitate safe and independent crossing of pedestrians with low vision and vision impairment.
 - Acoustic devices should be installed on a pole at the point of origin of crossing and not at the point of destination.
- Tactile paving should be provided in the line of travel **avoiding obstructions such as manholes/ tree guards/lamp posts etc.**

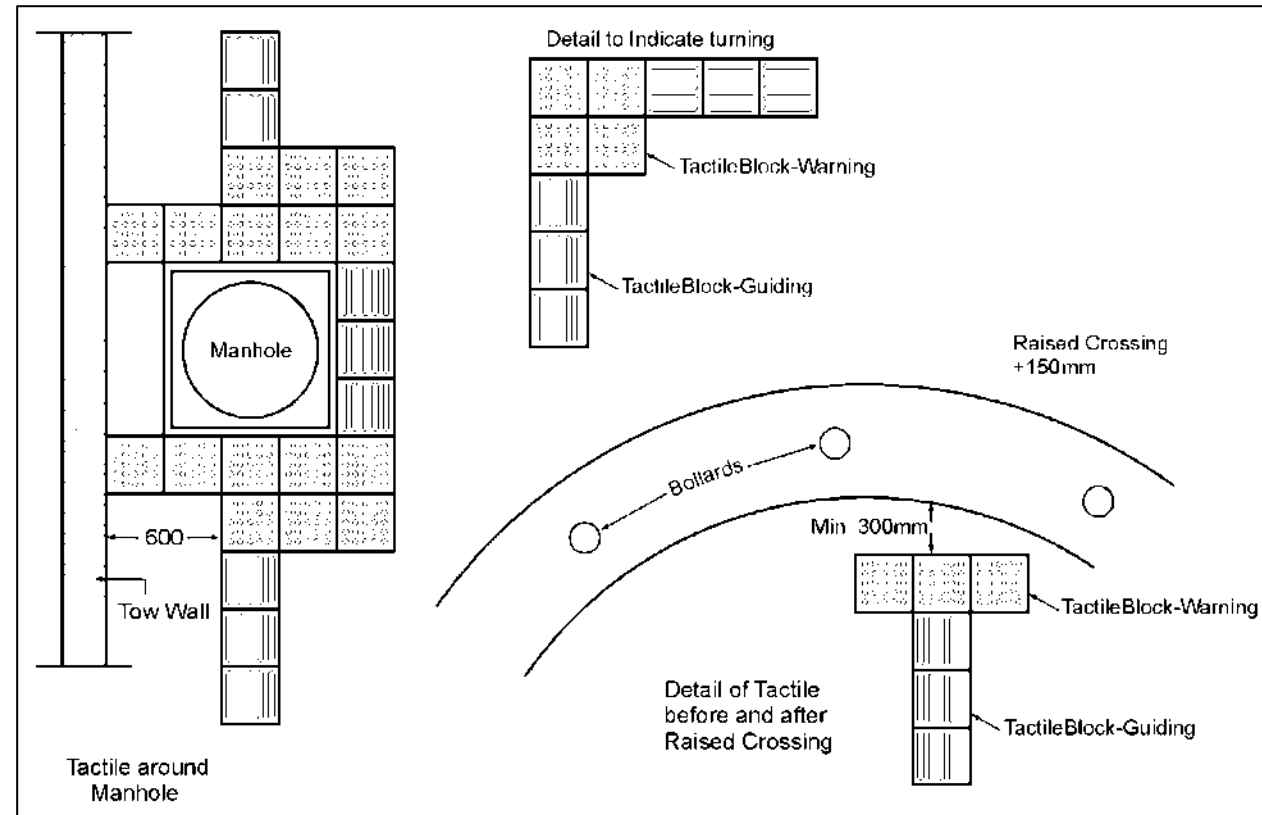

Tactile lay out for manhole and raised crossing

03E Accessible Infrastructure (See also Section 10)

Best Practices

Key Design Guidelines:*

- A slope of 8% (1 in 12) on footbridge ramps, while a slope of 5% (1 in 20) with appropriate resting places/landings is preferable .
- Within the underpass, a handrail set 850mm-900mm (Figure 32 & 33) above the walking surface should be provided.
- To assist visually impaired people, tactile paving/ tiles and a colour contrast should be provided at the top and bottom of the flight of steps and these areas should be well lit.
- Elevator/lift should be provide on both the entrances/exits and should have minimum internal dimensions of 1400mm x 1400mm.
- All Lifts to have Braille buttons and audio announcement systems.

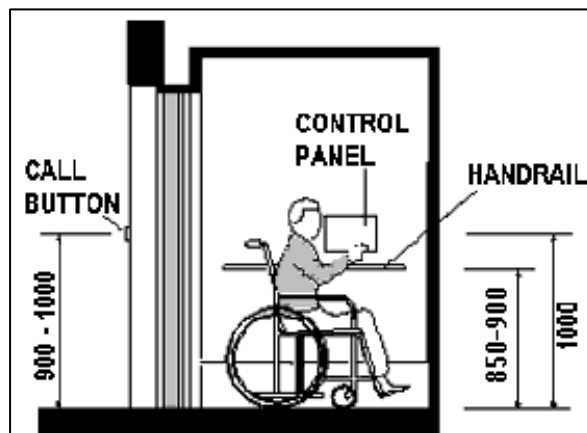
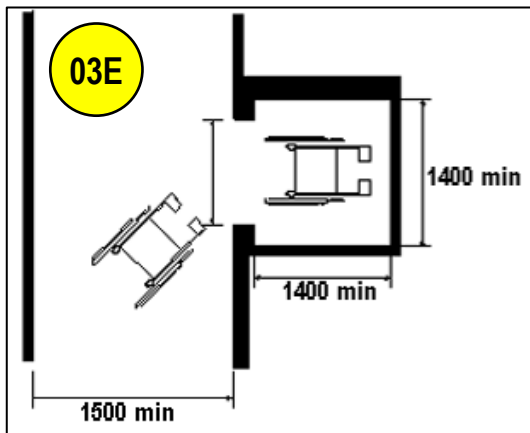

Braille Letters

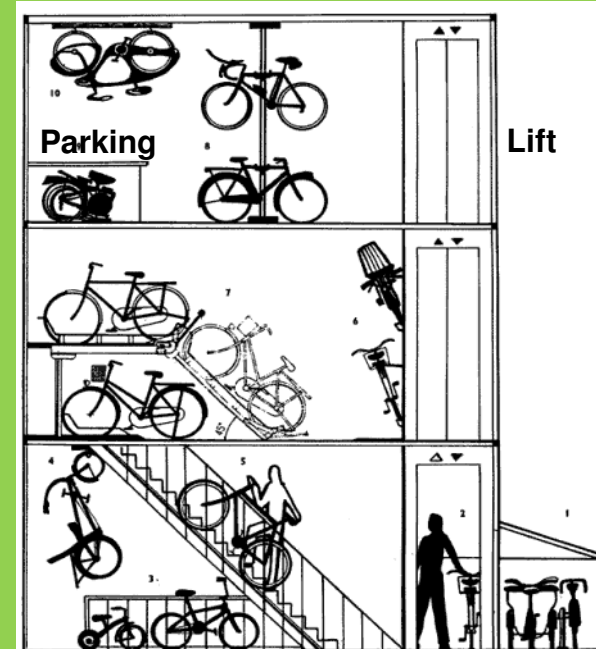
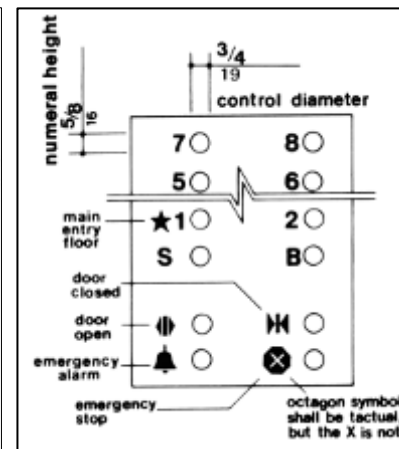
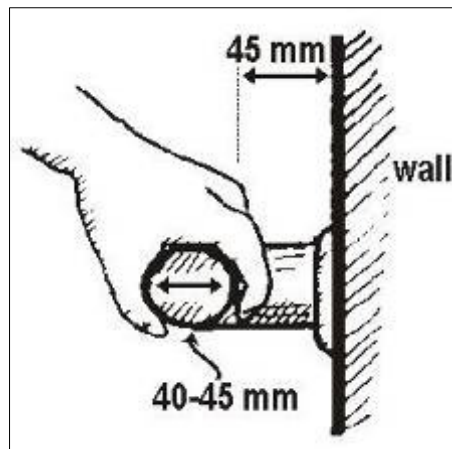
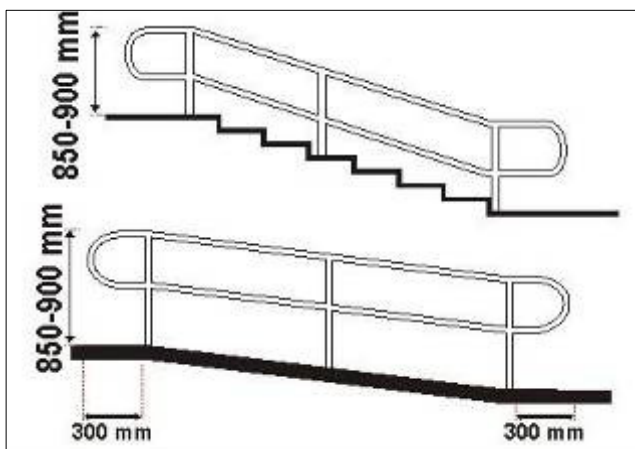

Cycle Lift must be minimum 2000 x 1400 and provided at every 1 km on a highway FOB, and at all public buildings.

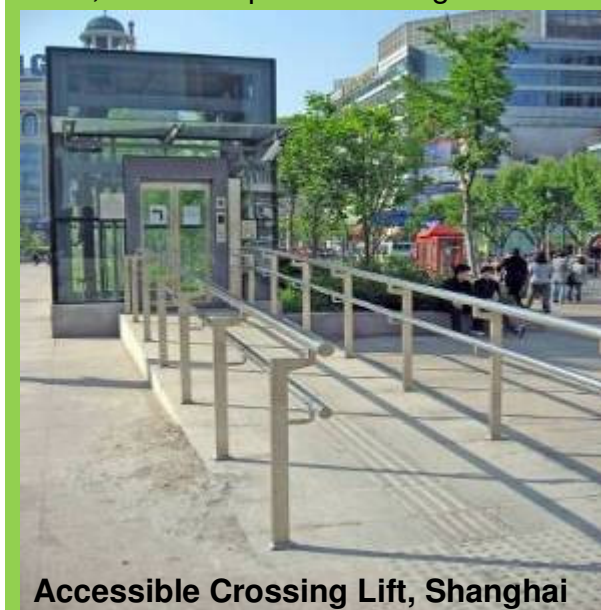

*Source: Access for All, Guidelines for TOT for promotion of Universal Design, 2008, Samarthyam

This page is intentionally left blank.

04 Multi-Functional Zone with Planting

- 04A Essential Planting
- 04B Tree Pits and Tree Grates
- 04C Planting with Storm Water Management
- 04D Aesthetic Planting



Multifunctional Planting zones with native Street Trees and Plantation – are Essential on every Delhi pavement to provide shade and climatic comfort. Planting zones can also double as Natural Storm Water catchments and filtration systems - aiding in ground water recharge, preventing seasonal flooding and reducing the pressure on piped stormwater infrastructure.

MAIN PRINCIPLES:

Mobility

- Avenue tree plantation is a must on all streets of Delhi in order to provide shade and comfort to pedestrians.

Ecology:

- Integrated Natural Drainage Systems
- Native plantation for resistance and water conservation.

Safety/Comfort

- Tree planting zones with native street trees and plantation – are essential for shade, lowering HIE and giving comfort to pedestrians.
- Tree planting zone should be CLEAR of the pedestrian walking zone

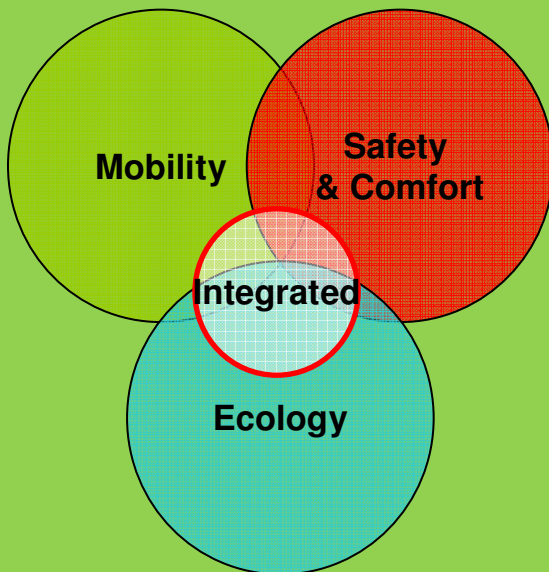

04 Multi-Functional Zone (MFZ) with Planting, Etc.

* Multi-Functional Zones on a Street may accommodate all functions described in Section 10, pg. 103, as well as the following:

- Tree Planting
- Planting for Storm Water Management
- Auto-rickshaw Stands
- Cycle-rickshaw Stands
- Hawker Zones
- Paid Car Parking
- Street Furniture
- Bus Stops
- Traffic Police Booths, MTNL boxes, fire hydrants, junction boxes, etc.
- Street lights/ pedestrian lights.

- Multi-Functional Zones on a Street should be a **minimum of 1.8 M Wide**, and may locate multiple functions.
- Provision of MFZ is most critical otherwise the uses/ components of streets (mentioned to the left) would encroach upon pedestrian, NMV or carriageway space.
- Common Utility Ducts and Duct Banks **should not be** located under the MFZ as there may be interference due to trees.

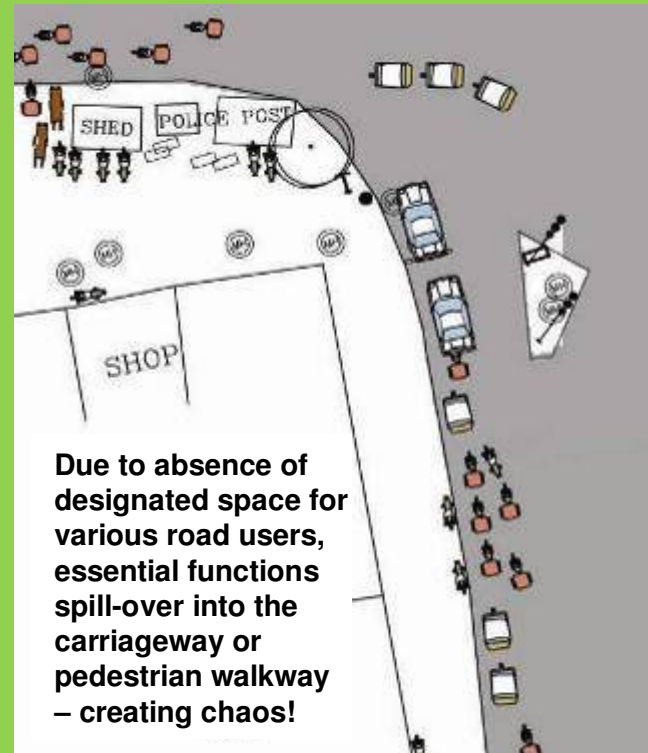
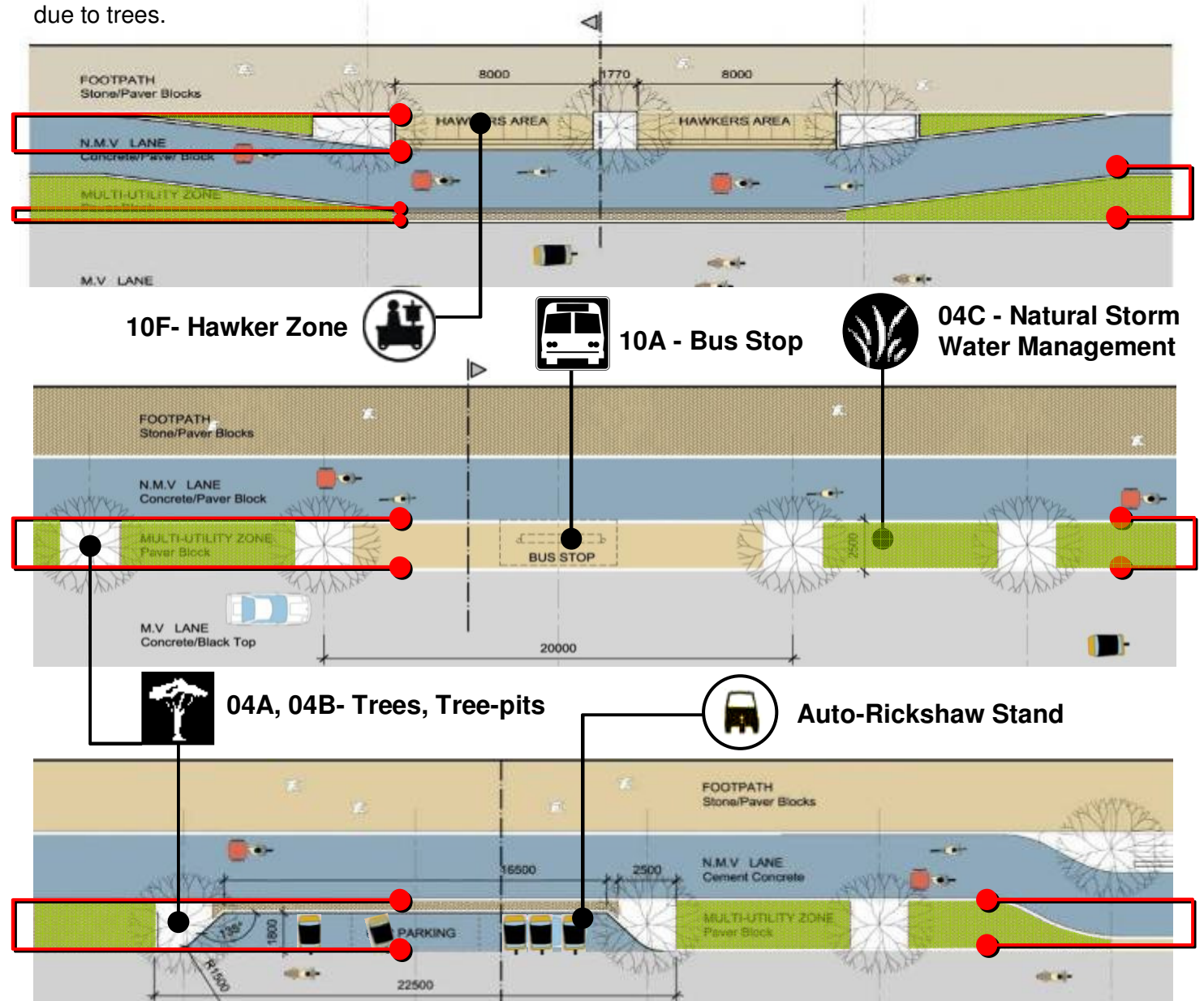

04 Multi-Functional Zone with Planting

Best Practices



Continuous planting zones are suitable for areas where pedestrian volumes are less and they need to be contained within the walking zone.



Retail (shopping streets) should have trees in tree-guards (and not continuous planting strips) – to allow more flexibility and space for pedestrian movement.



Portland

- Pedestrian corridor and Utility Easements must be placed **separately** from the **Tree Planting Zone**.
- **Ideally Utilities should be placed in ducts or duct banks**, for easy maintenance.
- For the health of trees and preventing their disruption during utility repairs & other pavement activities, street trees must have the **Standard Clearances**:

From	To	Standard Clearance from Tree
Centerline of Tree	Face of kerb	3.5 feet
	Pavement or pavement landing	2 feet
	Driveway (measured from edge of driveway at pavement)	7.5 feet
	Centerline of streetlight poles	20 feet (varies by type of tree)
	Centerline of utility poles	10 feet
	Extension of cross street kerb at an intersection	30 feet
	Underground utility duct, pipe or vault	5 feet

Source: http://www.seattle.gov/transportation/rowmanual/manual/6_4.asp

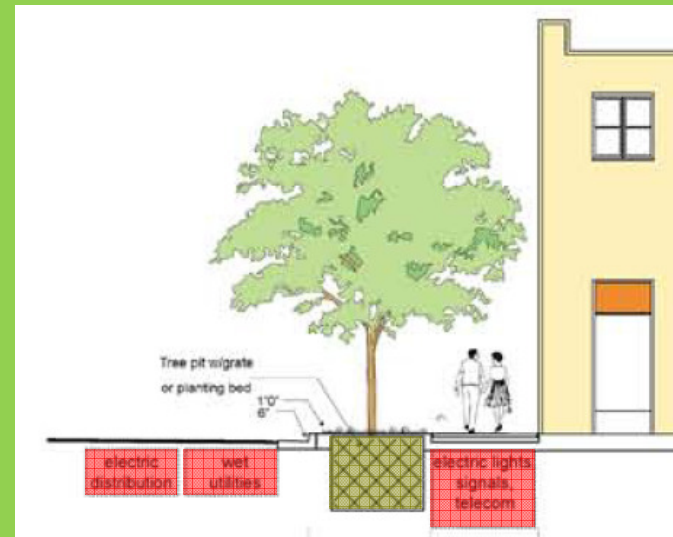



Delhi

Street Trees in same line as Utility Zone; and with low growing branches – thus obstructing walking zone.



Trees occupying walking zone, so pedestrian are displaced.

04A Essential Street Tree Planting

Street Trees are an essential on all Delhi Streets to provide the following:

- Provide shade to pedestrians and cyclists.
- Reduce local ambient heat through shading of surfaces and evaporative cooling - making the street more comfortable for all users.
- Absorb pollutants and improve local air quality.
- Increase local humidity so help absorb dust.
- Help create a sense of enclosure and placemaking on streets by creating relaxation spaces.
- Flowering or deciduous trees create a changing seasonal urban experience on streets.

Key Design Guidelines:

- Trees are an indispensable element of streets in Delhi's harsh weather. Trees are NOT to be placed on a sidewalk as an "afterthought" or in an ad-hoc manner in left-over spaces. **Trees must be planted in the specifically allocated MFZ which is an essential requirement on all categories of streets.**
- The Clear Pedestrian Zone (minimum 1.8 M Wide) and Utility Easements/ CUDs/ Duct Banks must be placed separately from the Tree Planting Zone/ MFZ.
- **Trees must be placed such that they do not obstruct street lighting** as well as visibility of traffic signals. Therefore the Tree Planting Plan must be prepared in conjunction with the Street Lighting Plan.
- Trees must be **pruned from the bottom** such that all safety devices, signage and traffic signals are clearly visible to all road users.
- Before the start of every project, all **existing trees** must be identified, numbered and marked on a Survey Plan and **kept intact as much as possible.**
- **Deciduous Trees** that shade in summer and shed their leaves to let sunlight through in winter are ideal for Delhi.
- **Only Native trees** should be planted on streets in order to minimize irrigation requirements and prolong tree life.
- Trees like Eucalyptus, Australian Acacia, Lantana, Lucena, Mast tree (False Ashoka) **should be avoided.**

04A Essential Street Tree Planting

Best Practices



- Narrow “columnar” trees to be used where pavement space is limited.
- Use trees that can be “pruned bottom-up” to allow vision clearance.
- Use deciduous trees to allow sunlight access to street in winter.



Ideally, provide “wide spread” but high canopied trees for shade in summers.

Dead Width Min. 1.8 M x 2.4 M Clear Pedestrian Zone with no Visual Obstructions Planting Zone

04A

10' Tree canopy clearance

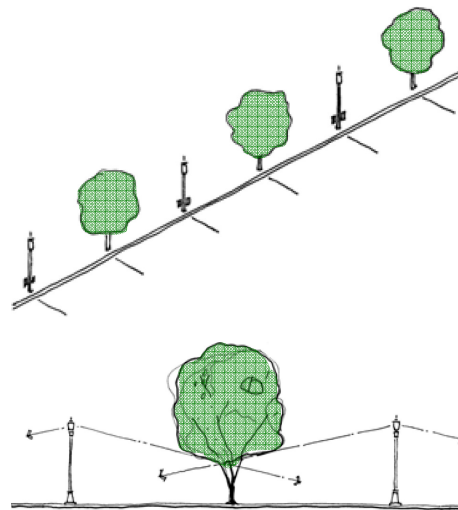

Tree planting plan and Lighting plans must be prepared in conjunction – so that tree canopies do not obstruct lighting for road users.



Utilizing deciduous trees is advisable on busy streets where sunlight is desirable in winter.

Current Situation



Suffocated Tree pits

- Delhi High Court, the city government said on 28 Oct 2009 it would ensure “breathing space” for every tree in the Capital — by keeping a circumference of 6 feet around it concrete-free.
- The assurance came in reply to an HC Petitioner who tells HC that concrete pavements are weakening tree roots, cutting off their water supply. This leads to ‘slightest of storms’ uprooting several trees, leading to



Open Tree pits are acceptable but they are difficult for pedestrians to walk over.

04B Tree Pits and Tree Grates

- A clear width of 1800 x 1800 M is to be left free of concrete, in order to allow access of nutrients to the roots of trees.
- Tree Grates allow pedestrians to walk close to trees, without discomfort to either.

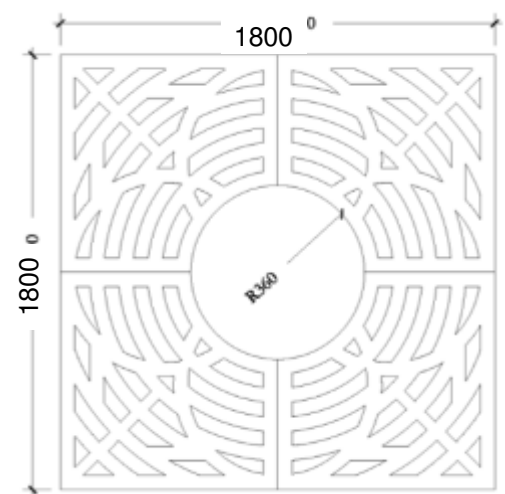
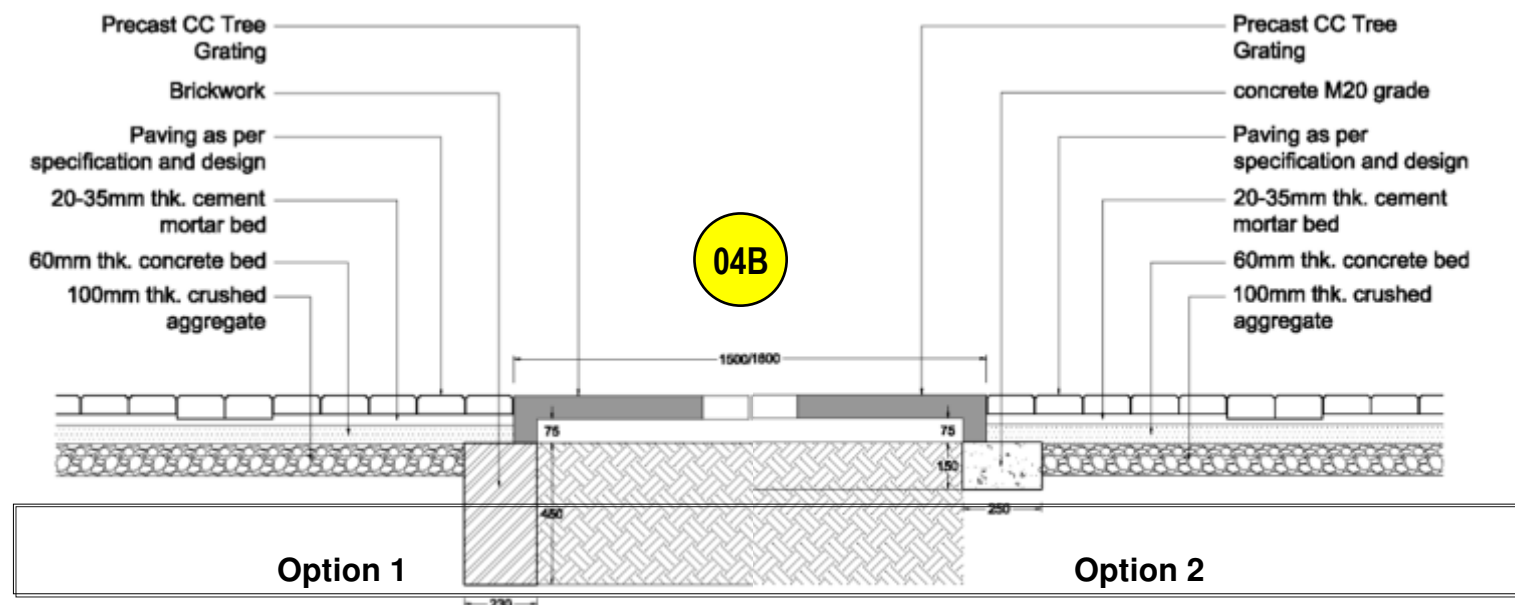

Sample Detail of Precast Cement Concrete Tree Grating.

Source: Pradeep Sachdeva Design Associates, Nov 2009

04B Tree Pits and Tree Grates

Best Practices

- Tree guards should be provided for young trees. Local materials like Bamboo to be used.
- Tree gratings finished at the same level as surrounding pavement – allow people to walk over them, while still allowing water, air and nutrients to access the roots.



Bamboo Tree guard by PSDA



Tree guard in Mumbai



Permeable Brick-Tile Tree Pit



Permeable Cement-Tile Tree Pit



Stormwater 'Raingarden' Tree Pit



Permeable Cement-Tile Tree Pit



Cobble Stone Tree Pit
Source: Better Streets, San Francisco



Precast Cement Concrete Tree Grate

Current Situation



Silted Open Drain, Tughlaqabad Institutional Area

Overflowing Storm Water Inlet, ITO



Natural Storm Water Management can be incorporated along Planting Strips of Roads.

04C Planting Strip with Storm Water Management

Current:

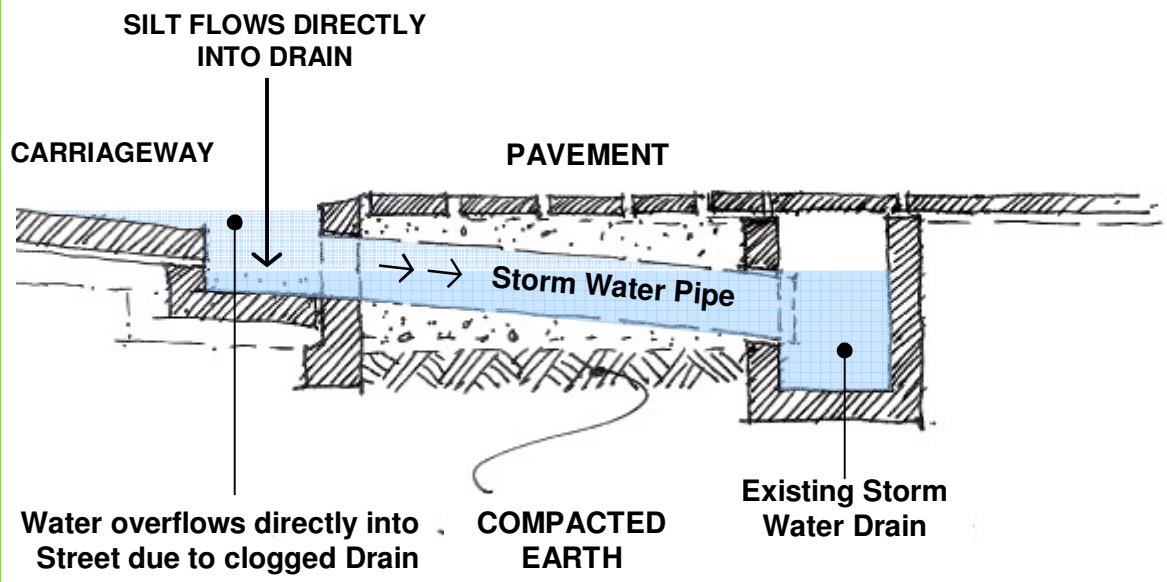

- Storm Water and Silt flows directly into the S.W. rain, carrying all pollutants with it.
- Slope of S.W. Pipe prevent rain from being used to pull capacity.

04C

Proposed Option: Bioswale

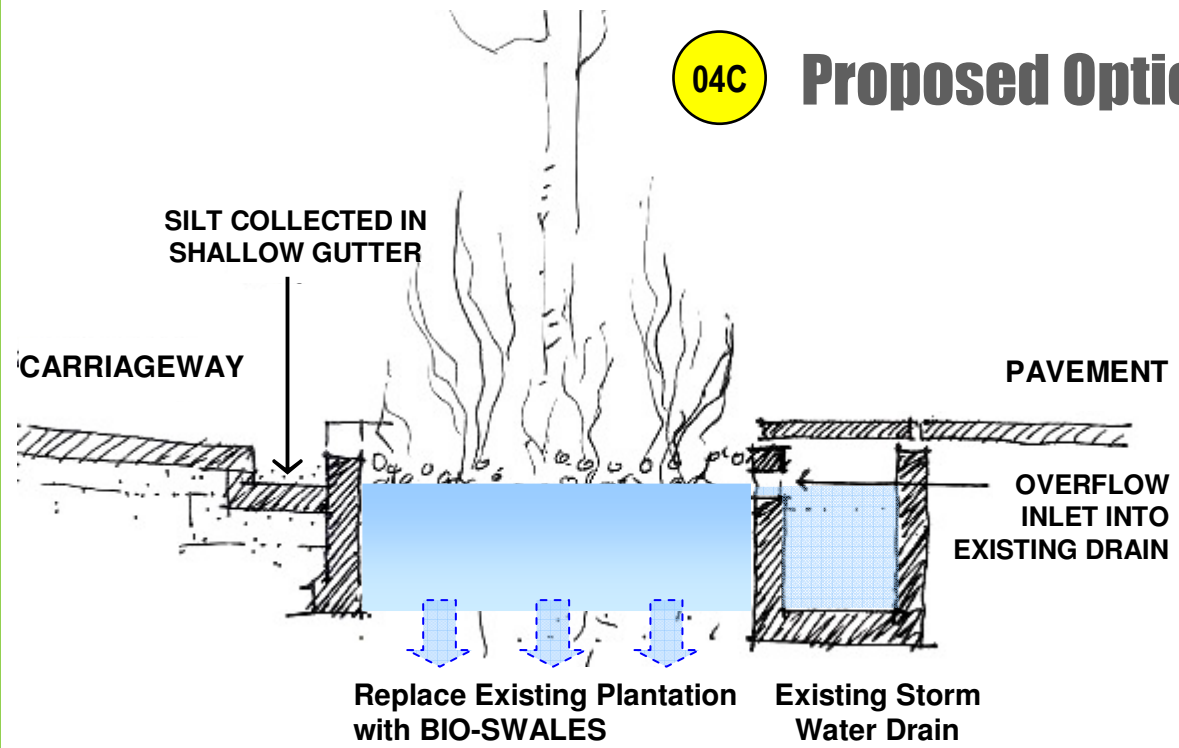

- Storm Water flows directly into a Bio-filtration or Bio-retention Swale.
- Water is retained and infiltrated in the bio-swale.
- In heavy rains, extra stormwater overflows into the existing S.W. Drain.

Sketches Source: Romi Roy, Sr. Consultant, UTTIPEC DDA, Oct 2009

04C Planting Strip with Storm Water Management

Best Practices

How the Science works:

Filtration:

Sediments suspended in stormwater runoff settle out and are deposited on planter soil.

Adsorption:

Pollutants in water attach to the surface of plants and soil particles where roots and bacteria can use them.

Storage:

Roots, insects, and worms break up soil, making more room for stormwater runoff

Plant Uptake:

Water, nitrogen, phosphorous and trace elements are used for plant function.

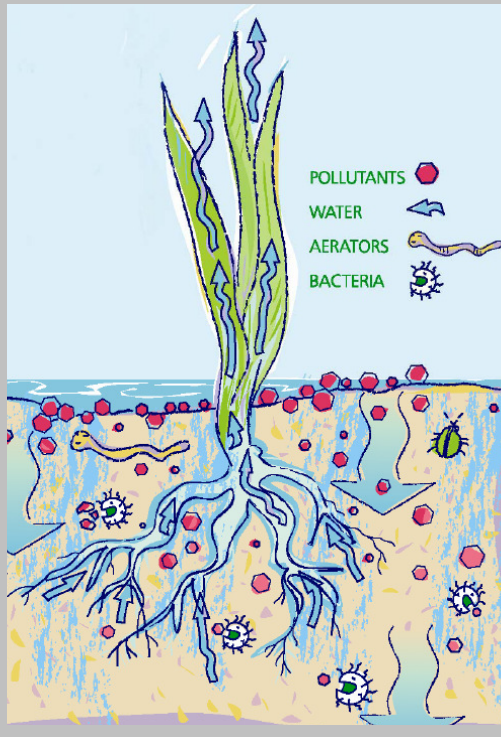

- Bioswales can connect to the Main Storm Water Drain – either in Series (connected only at the end); or in parallel – i.e. each bioswale bed overflows directly into the Storm Water drain, in case of heavy rainfall.
- The Parellel Connection option is preferable.
- **Adding organic compost or mulch to soil** improves its ability to support plants and absorb stormwater. Healthy soil is the backbone of natural drainage systems.
- The following Plants may be suitable for Delhi's soil and climate conditions:
 - Scirpus
 - Cyprus
 - Canna
 - Typha
 - Phragmites

“Green Streets”, Portland.

Photos: Seattle Department of Transportation.

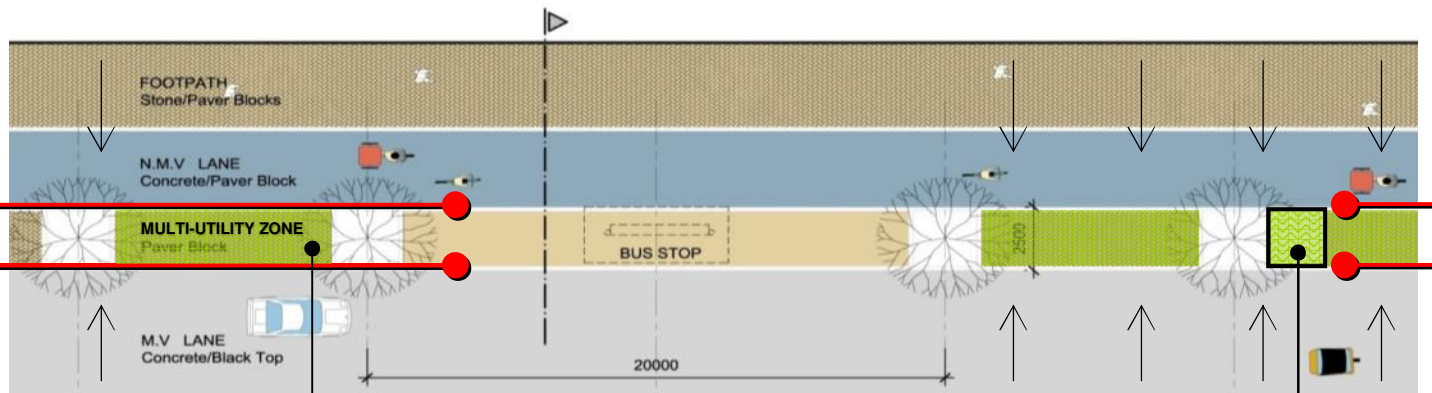

See Appendix-I for Details

04C

Bio-Swale within the Multi-Functional Zone

Intermediate Storm water 'Percolation Pits'

Areas that could be used for Storm Water Management in Roads:



Areas under Flyovers



Landscape Medians



Roadside Planting

04C-a 3-STEPS for Natural Storm Water Management



Three-step City-level Natural Treatment process:



Street bio-filtration bed

1 **Treat/ Infiltrate at Source: "Living Streets".**
Use street-swales or raingardens to filter and convey water naturally. This saves on piping cost, while providing additional greenery.



Parks/ Retention

2 **Capture and Convey Naturally: Multi-use Parks.**
Parks and Open spaces should be multi-used as retention ponds during rainy seasons.

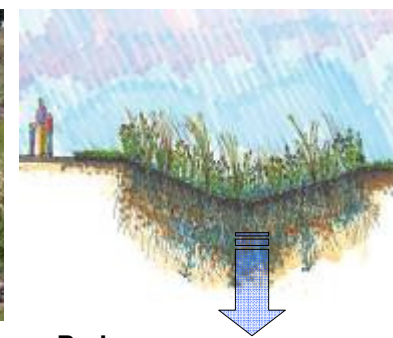

Example: An Integrated Landscape Plan

- 3** Protected & Constructed Wetlands
- 1/2** Urban Drainage & Linear Park System
- Neighborhood Park / Open Space
- Urban Recreation Zone



Wetlands**



3 **Final treatment** of remaining storm water can take place at a natural treatment **wetland** or drain into the Existing Storm Water Drain.

04D Aesthetic Street Tree Planting

Best Practices

04D

- **Deciduous Trees** that shade in summer and shed their leaves to let sunlight through in winter are ideal for Delhi.
- **Only Native trees** should be planted on streets in order to minimize irrigation requirements and prolong tree life.
- Trees like Eucalyptus, Australian Acacia, Lantana, Lucena, Mast tree (False Ashoka) **should be avoided.**



Kachnar



Tesu

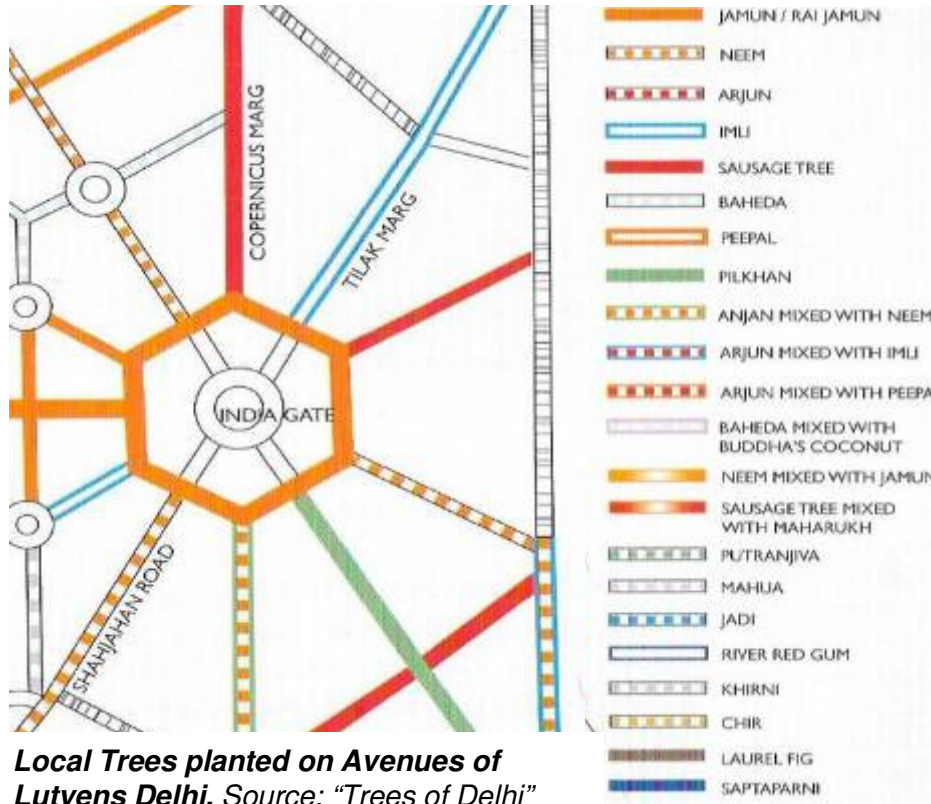

Local Trees planted on Avenues of Lutyens Delhi. Source: "Trees of Delhi"

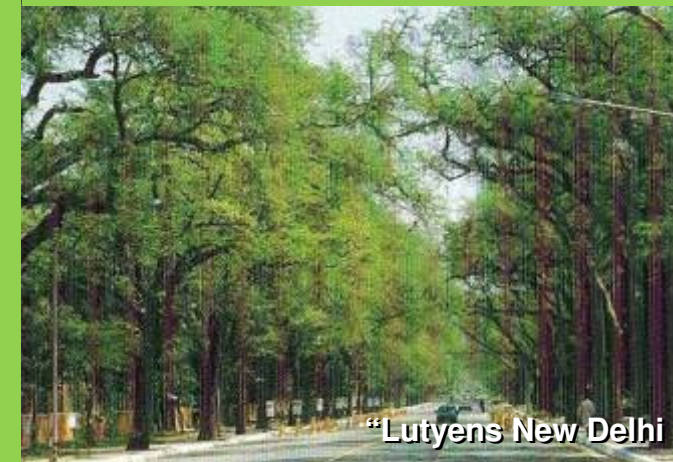

"Lutyens New Delhi"



Shown above: Imlu (Tamarind) Trees on Akbar Road in April (top) and February in autumn (bottom).

Example:
Street Tree Typologies proposed Streetscaping of Streets for Commonwealth Games 2010:

Avenue Trees:

- Arjun, Terminalia arjuna
- Kusum, Schleicheria oleosa
- Imlu, Tamarindus indica
- Kanak Champa, Pterospermum
- Chikrassy, Chukrasia tabularis
- Mahua, Madhuca indica

Accent Trees:

- Kachnar, Bauhinia variegata
- Barna, Crataeva adansonii
- Tesu, Butea monosperma
- Tota, Erythrina variegata
- Tabebuia, Tabebuia aurea
- Jacaranda, Jacaranda mimosifolia

- Streets could be "themed" based on the seasonal colour of foliage, flowers and fruits – in order to give a unique and beautiful urban experience to Delhiites.
- Deciduous trees provide shade in summer; change colour of their leaves in autumn; and shed leaves and let the sun through in winter.

This page is intentionally left blank.

05 Bicycle and Non-Motorized Transport Infrastructure

05A Segregated Cycle + NMT Tracks

05B Bicycle Parking and Other Infrastructure



Provision for introducing cycle tracks, pedestrian and disabled friendly features in arterial and sub-arterial roads is a must. (MPD-2021)

Bicycles, Rickshaws and other Non-Motorized transport are essential and the most eco-friendly feeder services to and from MRTS stations. **They are also indispensable for short & medium length trips for shopping, daily needs, school, etc.** Providing safe and segregated NMT lanes on all Arterial and Collector Streets would encourage their use and reduce the dependency of people on the private car...

MAIN PRINCIPLES:

Mobility

- Continuous and safe NMT lanes with adequate crossings are essential throughout the city
- Ample parking facilities for NMTs must be provided at all MRTS stations

Ecology:

- The most eco-friendly mode of transportation.

Safety/Comfort

- Safe crossings for NMT are essential for their safety.
- NMT lanes must be segregated from faster motorized traffic.
- Shade must be provide along NMT lanes as well as at traffic signals.

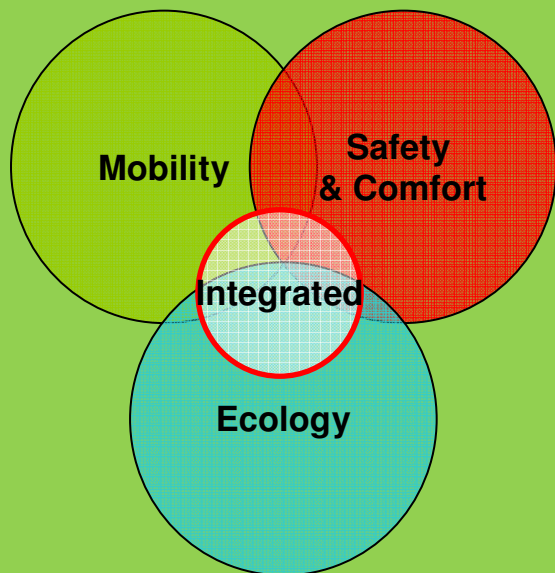

Not Preferable



'Marked' Cycle Lanes have failed in Delhi as vehicles freely drive and park on these cycle lanes.

Marked lanes also suffer from lack of visibility. **Lack of physical separation** also deprives cycles of safety and does not allow them to pick up speed.



Mixing of modes slows down everyone and creates chaos!

05A Segregated Cycle and NMT Tracks



Key Principles:

- **Cycle Lane** - A portion of a roadway that has been **designed by striping, signs, and pavement markings** for the preferential or exclusive use of bicyclists.
- **Cycle Track** - A Track intended for the use of bicycles that is **physically separated from motorized vehicle traffic** by an open space or barrier within the existing ROW.
- Provision for introducing cycle tracks, pedestrian and disabled friendly features in arterial and sub-arterial roads is a must, as per **MPD-2021. Minimum acceptable Width for single lane movement is 2.0 M.**
- **NMT Lanes** are meant for **Bicycles, Cycle-Rickshaws, Hand pushcarts, Hawker carts, animal drawn carts, etc.**

Key Guidelines:

- NMVs are the second most vulnerable group of road users and therefore must be clearly **segregated from faster moving motorized traffic, especially on Roads designed for motorized speeds of**
- The NMV lane should be constructed with **smooth-finished cement Concrete or Asphalt** in order to ensure a low maintenance and smooth riding surface. In the absence of this, cyclists will tend to move into the MV lanes which may be more comfortable.
- **Minimum Dimension of NMV Track is 2.5 M.**
- NMV Lanes or Tracks should be located on both sides of the street.
- **A 0.7 M landscaped buffer should be kept between NMV and MV lanes** in order to maximize the speed, efficiency and capacity of the NMV Lane.

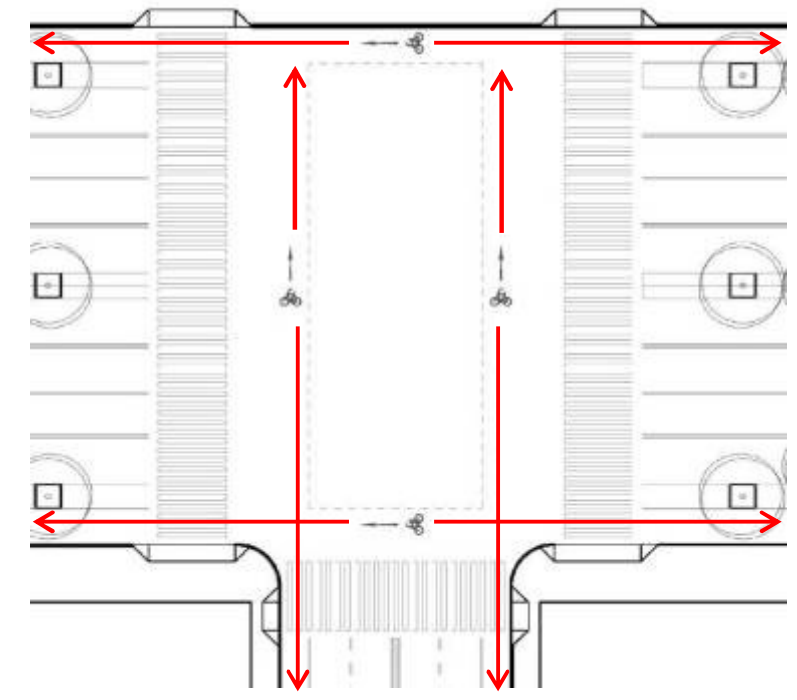

NMV lanes must be given clear crossing Tracks at junctions.

05A Bicycle and NMT Tracks

Best Practices

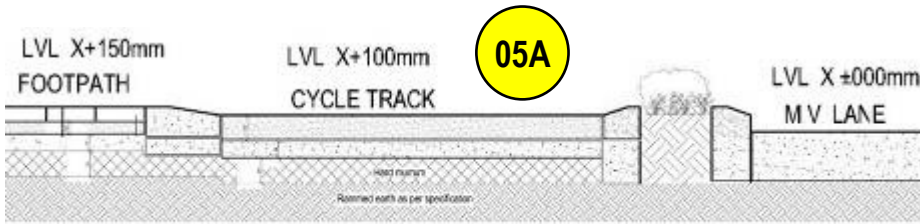

Relative Levels of NMV Tracks and Footpaths.
Source: TRIPP, IIT Delhi, BRT Design Specifications, 2009

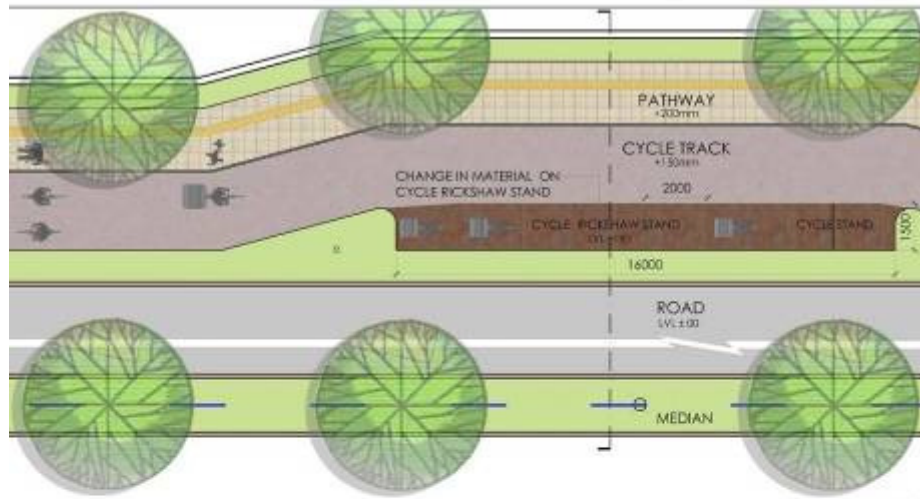

Cycle track on Public Staircase, Europe



Segregated Cycle-NMV Track, BRT Corridor, Delhi



Segregated TWO-WAY Cycle Track, Canal Street, Manhattan

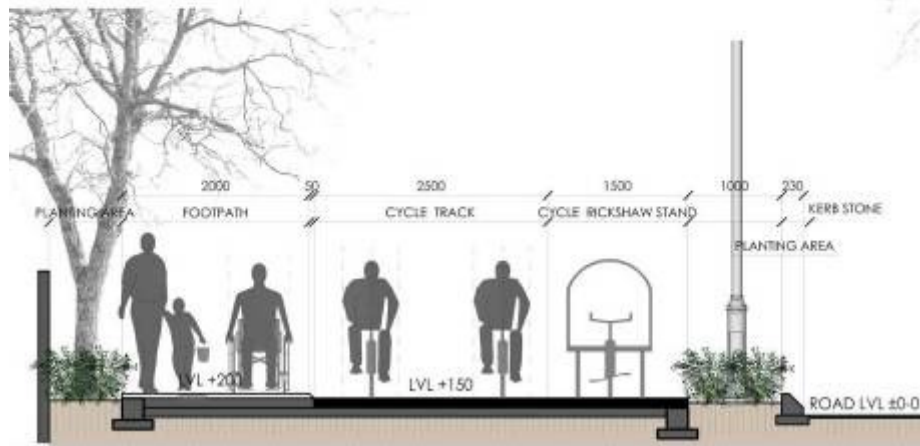

2.5 M is the Optimum Cycle Track Width. 1.5 M Width is required for Cycle Rickshaw Parking. Detail Source: Oasis Designs Inc.



Shaded Waiting Area for Cycles at Road Junction, Hangzhou, China



Segregated Cycle Track on 20 M Road, Manhattan



80% of Cycles under the Paris Cycle Share Program are stolen or damaged.

Source: Samuel Bollendorff for The New York Times



Open lockable parking bays like above may not succeed in Delhi – due to fear of theft or vandalism. However, they may work as a short term (10-minute) parking option.

05B Bicycle Parking and Other Infrastructure

Key Principles:

- Cycles are a very desirable and affordable private feeder service to MRTS/ BRTS Stations.
- To encourage their usage therefore - safe and secure cycle parking options must be provided.
- Secure Cycle Parking must be provided at all MRTS/ BRTS Stations.

Key Guidelines:

- **Long-Stay Parking** – Cycle parking lots must be enclosed, ticketed (like car-parking lots) and shaded from weather. Cycle parking lots can be combined with ticket counter booths, local police booths, cycle service stations or shared areas within private building complexes.
- **Short-stay parking** – should be open to view and close to entrances of destinations.

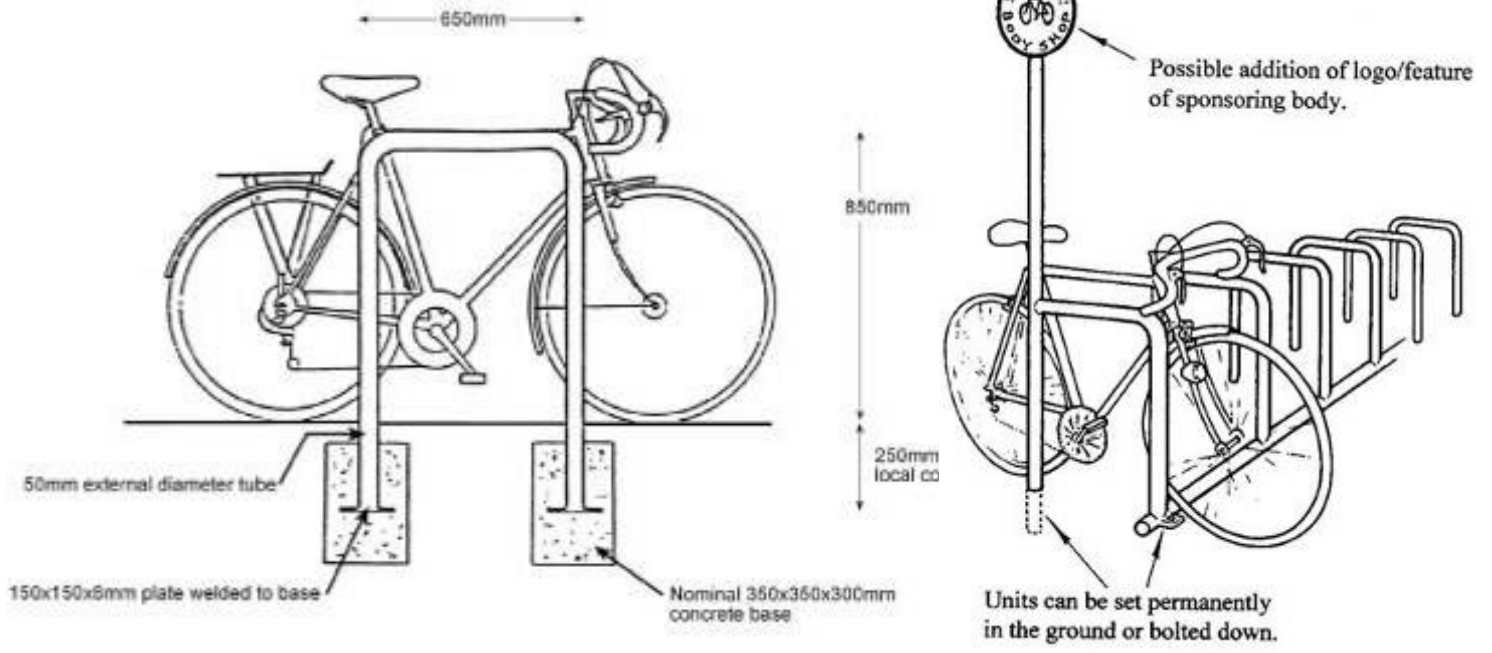

The stands should allow at least the frame and ideally both wheels, to be secured to them.

A typical Cycle Stand is shown above.

Source: http://www.norwich.gov.uk/local_plan/images/figures/diag1a.jpg

http://www.bolsover.gov.uk/localplan/ws_pics/image005.jpg

05B Bicycle Parking and Other Infrastructure

Best Practices

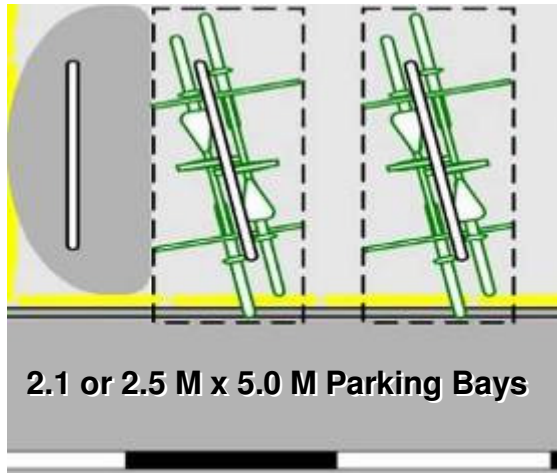

Graphic Source:
http://www.hackney-cyclists.org.uk/parking/on_street_x.jpg



A Cycle-repair stall next to a Cycle Track, Shanghai



Public Cycle Parking in a Private Compound



Stacked Cycle Parking, China



Shaded and Ticketed cycle Parking, Beijing

SAMPLE CYCLE PARKING PLAN

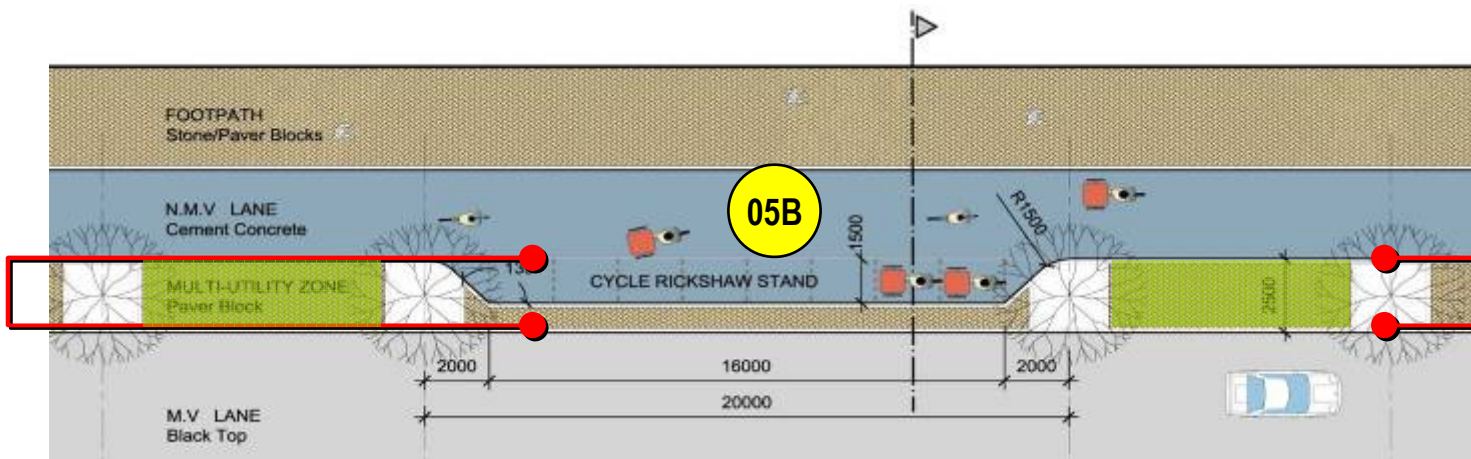

Cycle Rickshaw Parking, Cycle Parking Stands, Cycle repair Stalls, etc. can all be accommodated within the Flexible “Multi-Functional Zone” (Section 04)

This page is intentionally left blank.

06 Crossings

- 06A At-grade Full-Signal Crossings
- 06B Pedestrian Crossings
- 06C Raised Crossings - (see 03B)
- 06D Grade Separate Crossing (Foot Over Bridge)
- 06E Grade Separate Crossing (Humped Crossing)



Marked and designated crossings are an essential part of the pedestrian realm that enable safe, convenient pedestrian travel across roadways.

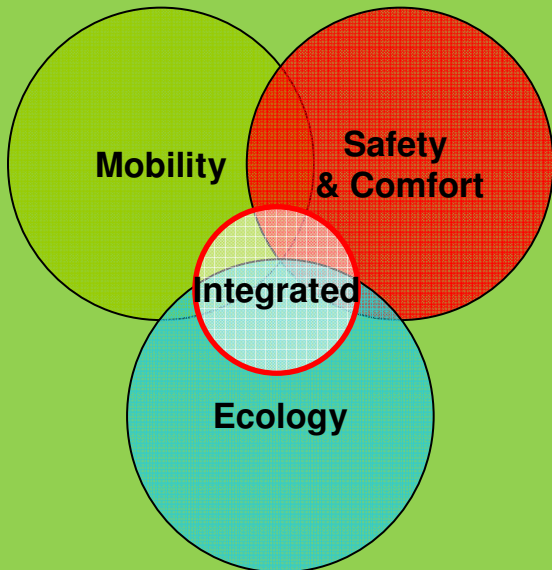

Key Principles:

- Since **Pedestrians must be given the shortest possible direct route to cross the street**, the most preferred Crossing for them is “at-grade”.
- **Mid Block Crossings** must be provided for people to cross the street safely between building entries or bus stop locations or active landuses on opposite sides of the street. Mid-block crossings may be provided with pedestrian operate signals and table top crossings.
- **At-grade Pedestrian crossings must be provided at all T-junctions.**
- **Grade separated crossings could be provided on highways.**



Textured Paving or Yield Lines for yielding before at-grade Signalized Intersections.



Full Signal Crossings are located either at Street junctions or at mid-block locations where the Median is punctured fully to allow crossing and full turning movements for all types or modes/vehicles.

Key Principles:*

- Crossings should be at least as wide as the sidewalk, and wider in locations with high pedestrian demand.
- Crossings should be no less than 3 M in width. A more desirable width is 5 M.
- Crossings must be outfitted with kerb ramps and tactile warning strips per accessibility guidelines in Section 03.
- All light signals are to have 'auditory' mechanism.
- **Advance stop and yield lines** should be considered at stop- or signal-controlled marked crossings with limited crossing visibility, poor driver compliance, or non-standard geometrics.
 - Stop and yield lines can be used from 1 to 15 M in advance of crossings, depending upon location, roadway configuration, vehicle speeds, and traffic control.
- **Traffic Calming** Treatment starting least 25 m before the zebra/ table-top crossing is essential in Delhi due to unruly traffic.
- **Wayfinding Signage** for Pedestrian orientation and directional guidance must be provided at street intersections. Amenities like dustbins are also needed. (Section 10)



Traffic Light Mounted Street Name Plate, with Address Range and Other Directional Signage.

See Section 10C: Sianaae

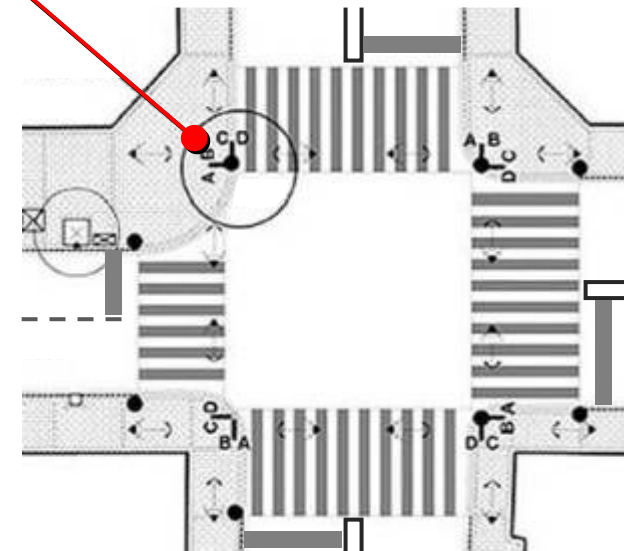

*Source: San Francisco Better Streets Plan

06B Pedestrian Crossings (See also 03B for Table-top Crossings)

Best Practices

Pedestrian (and NMV) Crossings are located at mid-block* locations where the Median is punctured minimally to only allow pedestrians and non-motorized modes to cross the roads safely at-grade.

Mid-block crossings must include the following:

- Signage visible from min. 100m away.
- Auditory signals are required to provide assistance to the differentially-abled.
- Traffic Calming Treatment **starting least 25 m** before the zebra/ table-top crossing.
- Minimum 20-second pedestrian signal – either as pelican or as a synchronized signal with the nearest full traffic signals.

Mid-block crossings to be provided at:

- Mid-block transit/ bus stop locations.
- Long blocks (>250M)
- Areas with pedestrian attractors with mid-block entries like shopping areas, schools and community centers.

➤ **Mid-block crossings must be provided at regular intervals as per following standards:**

Residential Areas:

Spacing Range: Every 80 – 250m

Coordinated with entry points of complexes; location of bus/ train stops, public facilities, etc.

Commercial/ Mixed Use Areas:

Spacing Range: Every 80 – 150m

High Intensity Commercial Areas:

Pedestrianize if possible.

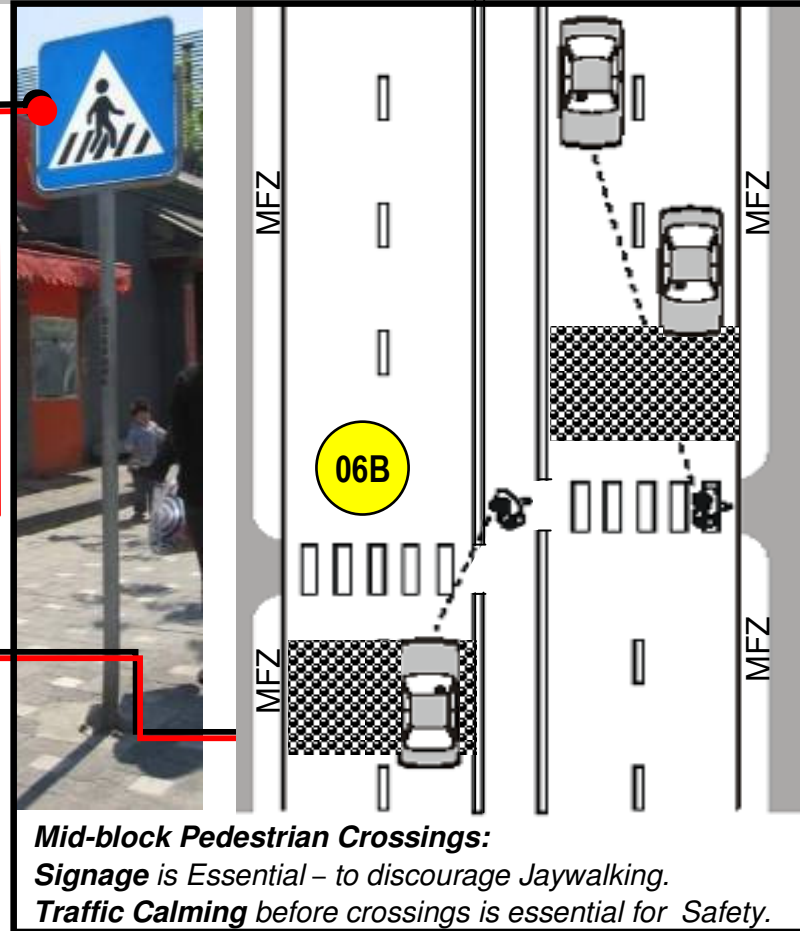

**** Extended Footway at Crossings provides better visibility of pedestrians and reduces the crossing distance.**



*Mid-block is a location along the Street where no intersecting road exists.

**Source: "American Association of State Highway and Transportation Officials", Pedestrian and Bicycle Safety, Lesson 12 Midblock Crossings

06D Foot Over-Bridges

Decision of 27th Governing Body meeting of UTTIPEC:*

- **Foot Over Bridges** are to be the **exception, not the rule**. They are to be provided only under circumstances where no at-grade crossings are feasible.
- **Underpasses** not to be provided at all, unless under extreme circumstances where no other solutions (including FOBs are feasible).
- **At-grade crossings** (raised table-tops or zebra crossings) with pedestrian/ pelican signals and adequate signage and traffic calming measures are to be used on all Urban Roads within city limits. Pedestrian signals (approx. 20 sec.) should be synchronized along with the nearest full traffic signals along all roads, including arterials and sub-arterials, for smooth movement of traffic along with safe pedestrian/ NMV crossing.
- **All FOB proposals must be brought to UTTIPEC for approval, before implementation.**

FOB consideration checklist is available at this link on the UTTIPEC Website:

<http://uttipec.nic.in/writereaddata/linkimages/FOBchecklist.pdf>

Key Design Guidelines (where used):*

- **Escalators are NOT an inclusive measure.** Minimum size for Elevator is 1400 x 1400 MM.
- Tactile paving/ tiles and a colour contrast should be provided at the top and bottom of the flight of steps and these areas should be well lit.

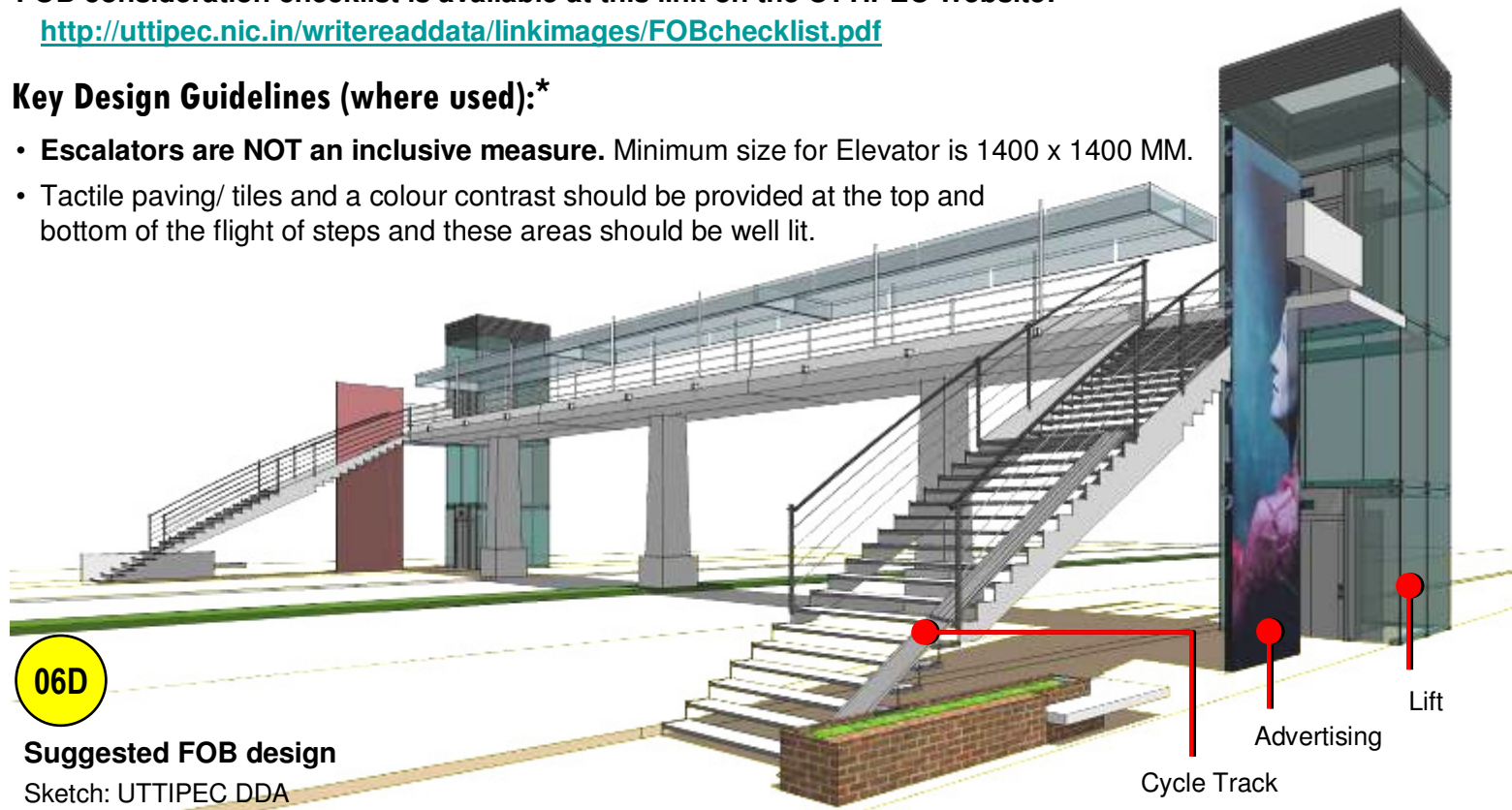

06D

Suggested FOB design

Sketch: UTTIPEC DDA

* 27th Governing Body Meeting Minutes <http://uttipec.nic.in/writereaddata/linkimages/1627805538.pdf>

06E Humped Pedestrian Crossings (Only on Highways)

Best Practices

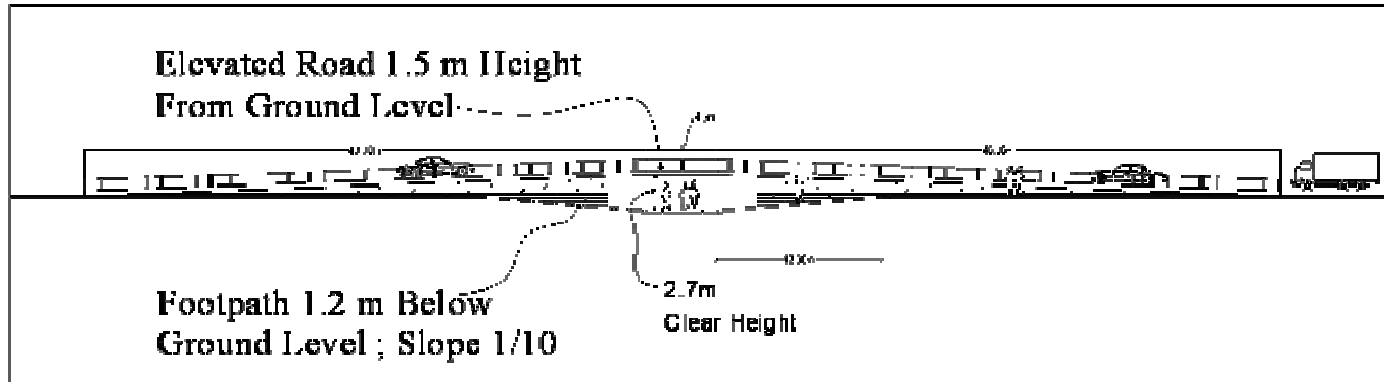

SECTION

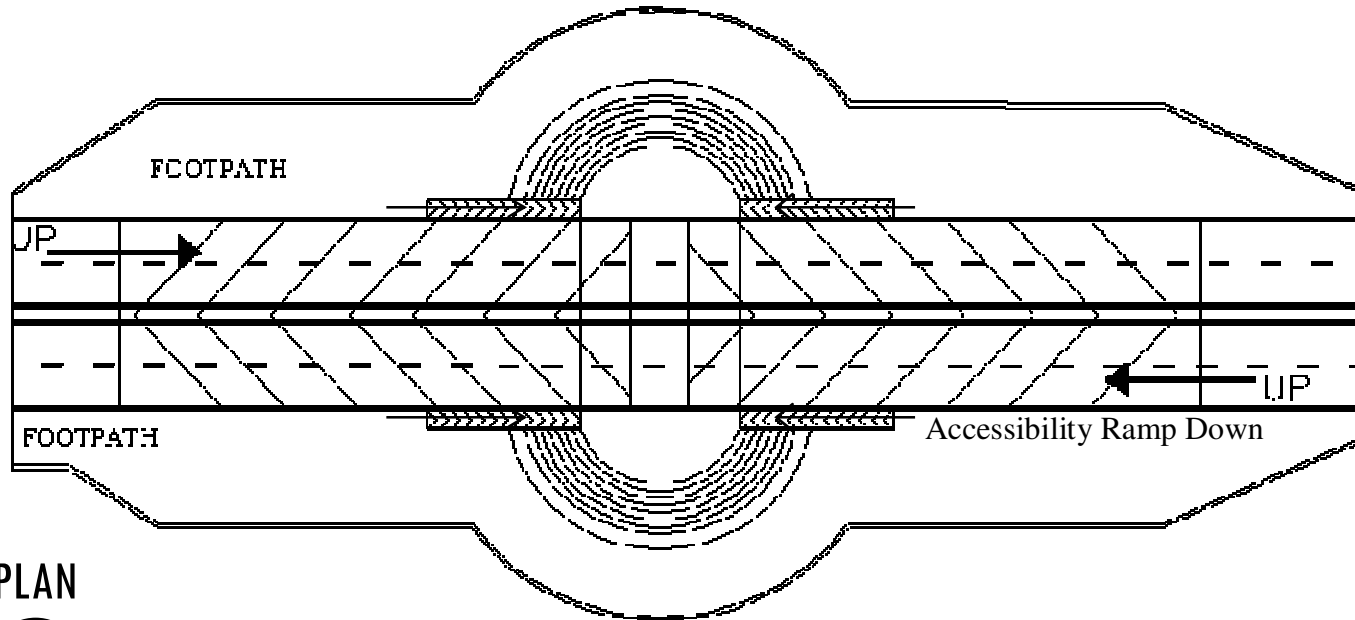

PLAN

06E

Sample Detail of a Humped Crossing (only for highways)

Source: EIL, Developments Consultant & Creative Arc Architects and Transport Planners

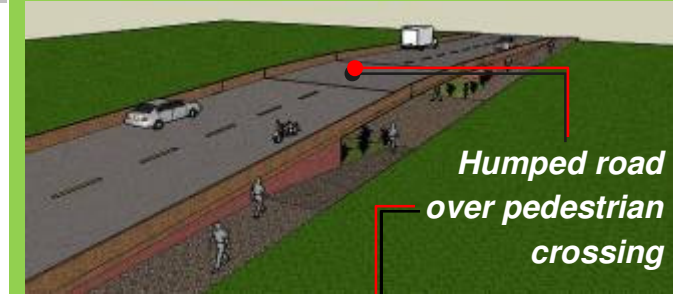

06F Other Geometric Guidelines for Cycle Tracks

Width for One way Traffic	Two Lane - 2.5 to 5.0 M Three Lane - Over 5.0 M Four Lane - -----
Width for Two Way Traffic	Two Lane - 2.5 MINIMUM Three Lane - 2000 to 5000 Four Lane - Over 5.0 M
Cycle Track - Types	Two types of cycle tracks: 1 Which run parallel to or along a main carriage way. A. Adjoining Cycle Tracks B. Raised Cycle Tracks C. Free Cycle Tracks 2 Which are constructed independent of any carriage way.
Cycle Track - Horizontal Curves	It should be so aligned that the radii of the horizontal curves are not less than 10 M (33 ft) . Where the track has a gradient steeper than 1 in 40 , the radii of the horizontal curves should not be less than 15 M (50 ft) . The radii of horizontal curves for independent cycle tracks should be as large as practicable .
Cycle Track - Vertical Curves	Vertical curves at changes in grade should have a minimum radius of 200 M (656 ft) for summit curves and 100 M (328 ft) for valley curves .
Cycle Track - Gradients	The length of grade should not exceed from 90 M (295 ft) to 500 M (1640 ft) for the gradient of 1 in 30 to 1 in 70, respectively . Gradients steeper than 1 in 30 should generally be avoided . Only in exceptional cases, gradients of 1 in 20 and 1 in 25 may be allowed for lengths not exceeding 20 M (65 ft) and 50 M (164 ft) respectively. Where the gradient of a carriage way is too steep for a parallel cycle track the latter may have to be taken along a detour to satisfy the requirements of this standard.
Cycle Track - Sight Distances	Cyclist should have a clear view of not less than 25 M (82 ft) . In the case of cycle tracks at gradients of 1 in 40 or steeper , cyclist should have a clear view of not less than 60 M (197 ft) .
Cycle Track - Lane width	The total width of pavement required for the movement of one cycle is 1.0 M (3 ft 3 in.) .
Cycle Track - Width of Pavement	The minimum width of pavement for a cycle track should not be less than 2 lanes, i.e., 2.0 M (6 ft 6 in.) . If overtaking is to be provided for, the width should be made 3.0 M (9.8 ft) . Each additional lane where required should be 1.0 M (3 ft 3 in.) wide .
Cycle Track - Clearance	Vertical clearance - The minimum head-room provided should be 2.25 M (7.38 ft) . Horizontal clearance - At underpass and similar other situations a side clearance of 25 cm should be allowed on each side . The minimum width of an underpass for a two-lane cycle track would , therefore, be 2.5 M (8.2 ft) . In such situations it would be desirable to increase the head-room by another 25 cm so as to provide a total vertical clearance of 2.5 M (8.2 ft) .
Cycle Track - Cycle tracks on bridges	Full width cycle tracks should be provided over the bridge. The height of the railing or parapet should be kept 15cm higher than required otherwise, when cycle track is located immediately next to bridge railing or parapet.
Cycle Track - General	Provided on both sides of a road and should be separated from main carriage way by a verge or a berm. Minimum width of the verge - 1.0M (3ft 3in.) Width of verge may reduced to 50cm (20 in.) . For a width of 50cm (20 in.) from the edge of the pavement of the cycle track, the verge or berms should be maintained so as to be usable by cyclists in an emergency. Cycle tracks should be located beyond the hedge, tree, or footpath. Kerbs should be avoided as far as possible. A clearance of at least 50 cm should be provided near hedges and of 1.0 M from trees or ditches .
Cycle Track - Road crossings	Where a cycle track crosses a road, the carriage way should be marked with appropriate road markings.

07 Medians and Refuge Islands

07A Pedestrian Refuge Island at Median

07B Median Refuge Design Options

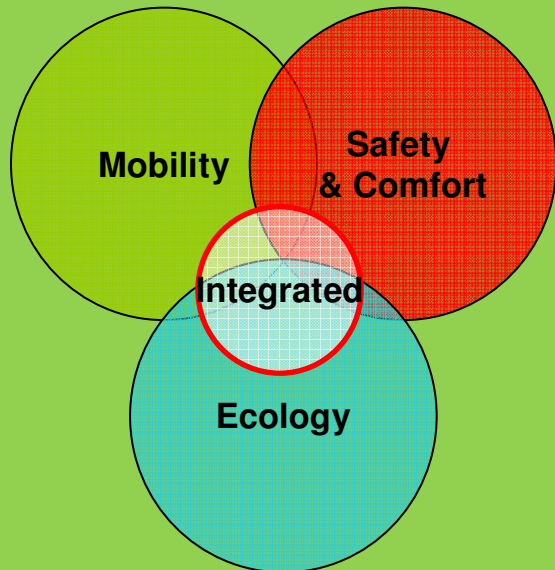

A median is the portion of the roadway separating opposing directions of the traveled way, or local lanes from through travel lanes. At a pedestrian crossing, the median acts as a ‘pedestrian refuge island’.

Functions and Benefits:

The provision for a **median** is a **function** of the road’s **design speed**.

Medians should be provided **only** on roads where **design speeds are greater than 20/25 km/hr**.

- On such roads, medians provide greenery and also safe refuge islands for pedestrians and cyclists to wait while crossing a wide road.

Medians should generally **NOT** be provided on roads with **design speed less than 20 km/hr or R/W lesser than or equal to 24m**.

- On such roads, a **coloured thick line** may be used.
- **Absence of median** on smaller neighbourhood roads causes people to keep their **speeds under control**.
- Absence of a median also **allows for lane flexibility** during peak hours.



Median fences totally inappropriate, especially on a residential, mixed-use, slow traffic street.



Inadequate, unusable refuge island at a signalized intersection in ITO

Median design at various widths:*

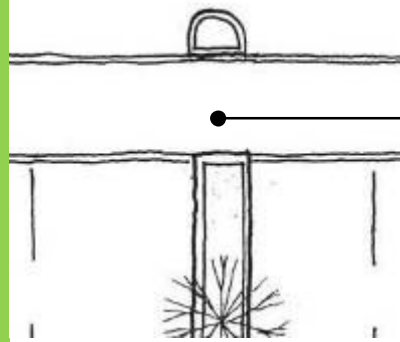

Median less than 2 M

- *Timed to cross in a single phase*
- *At-grade through refuge*
- *No detectable warnings*

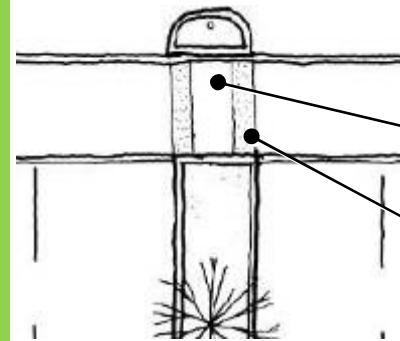

Median between 3 - 4 M

- *At-grade through refuge*
- *900 MM clear waiting area*
- *600 MM tactile warnings at refuge*

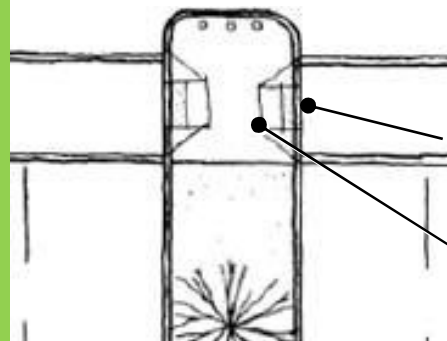

Median more than 4 M

- *Raised median at refuge.*
- *600 MM tactile warnings at refuge*
- *1200 MM clear waiting area*

Key Design Guidelines:*

- **Maximum height of Median kerb is 150 MM.** If higher medians are needed, they should be crash barriers.
- **Instead of fences, Medians should be landscaped and used for stormwater management wherever possible.**
 - Plantings should use drought-tolerant, low maintenance species, and preferably capable of storm water filtration as well.
- **When street trees are desired, a median should be min. 1.5 M wide,** including kerbs, to provide sufficient space for healthy root growth.
 - Trees in medians can provide a fuller canopy and provide a highly cooling effect on immediate surroundings, thus reducing Urban Heat Island Effect.
- **Clear width of a median 'refuge island' should be 1.2 M.**

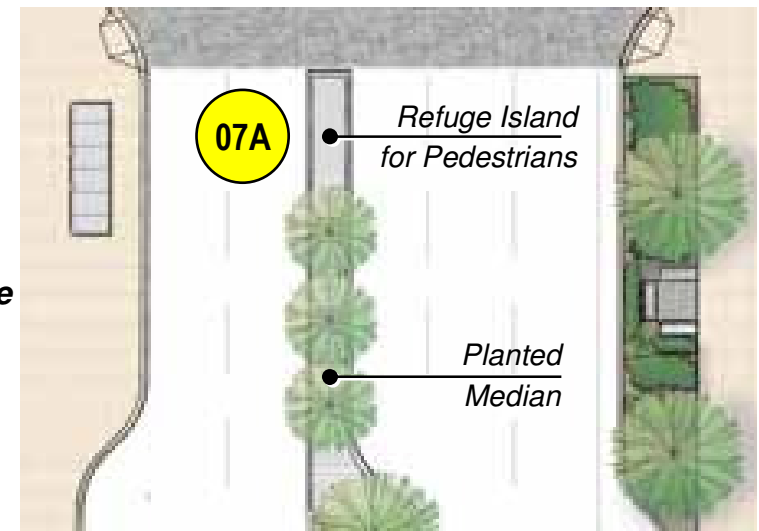

07B Pedestrian Refuge Island at Median

Best Practices

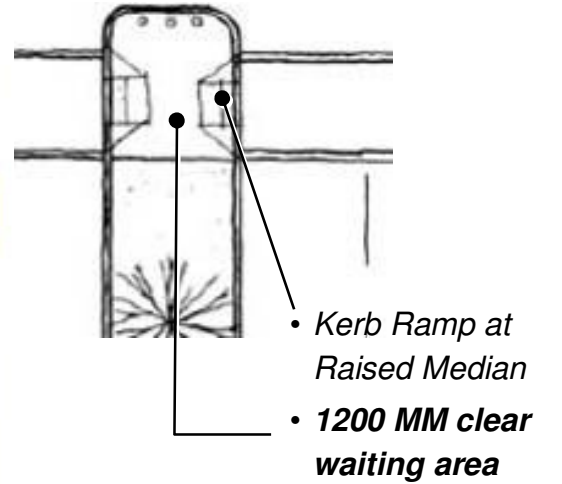
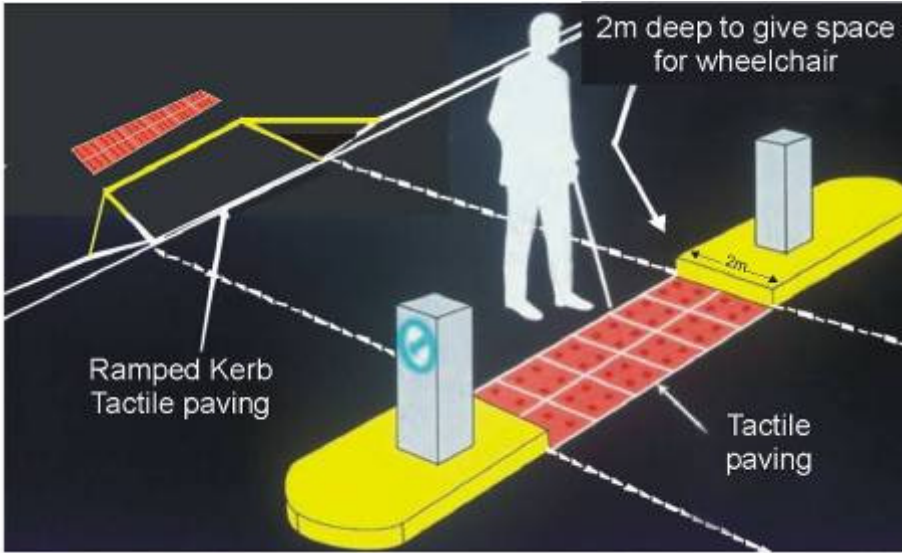

Raised Median more than 4 M Wide*



Landscaped Median, Lodhi Rd.

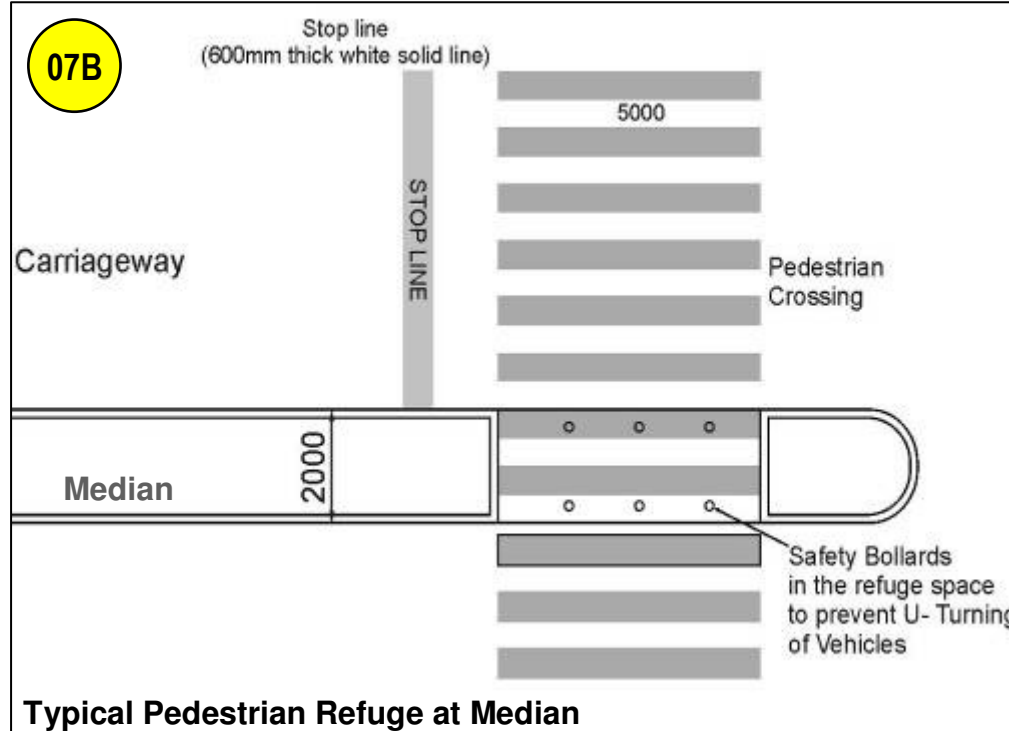

Typical Pedestrian Refuge at Median

(Drawing Courtesy: ICE and SG Architects)



At-grade Median Refuge*

Fences are futile if placed on the median.

The best use of medians is planting of trees and bioswales: reducing Heat Island effect and ambient temperature for the street & increasing its ecological value by treating and filtering stormwater on site.

Medians can be designed to retain, cleanse, and infiltrate stormwater runoff from the roadway, replenishing groundwater and decreasing the peak flow burden on stormwater infrastructure.

At-grade Median Refuges allow pedestrians to wait safely for crossing wide streets with long signal rotations.



At-grade Median Refuge*

This page is intentionally left blank.

08 Street Lighting

08A Pedestrian Scale Low-Mast Street Lighting

08B Full Cut-off Fixtures



Lighting needs of pedestrians are different from those of vehicular traffic and therefore need to be designed and integrated within the overall lighting strategy for the street. This would aid the safety of pedestrians on pavements after dark.

MAIN PRINCIPLES:

Mobility

- Optimal lighting for pedestrians to provide safety and security..
- Light poles must be CLEAR of the pedestrian walking zone.

Safety/Comfort

- Provide optimal lighting for pedestrians.
- Pedestrian lights should be placed lower and focusing on the pavement.

Ecology

- Provide FULL cut-off lighting fixtures to prevent spillage of light and wastage of energy, and also prevent night sky light pollution.

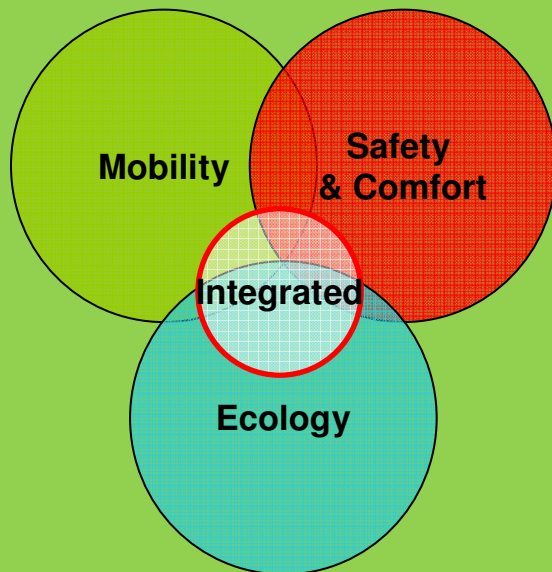



High Mast Lighting is inefficient and ineffective, especially in this narrow mixed-use street.



Light poles placed on the walkway so pedestrians are forced on to the road.

Intent:

- Safety of the most vulnerable road user - pedestrians.
- Increase sense of security and help keep streets active after dark.
- Provide comfortable and attractive night time visual environment.
- Reduce night-time accidents.

Key Design Guidelines:

1. **Height of Light Pole and Luminaire Type are a function of Street Width:**
 - High Mast Lighting (30 M tall) – are inefficient as too much light is dispersed into the night sky (causing light pollution) and not much light reaches the ground level.
 - Mid-Mast Lighting (10-12 M tall) – are appropriate for most Arterial and Sub-Arterial Streets. For Wide Streets with high pedestrian/ commercial activity, Mid-Mast lighting may be combined with Pedestrian Scale lighting to create additional security and comfort.
 - Low-Mast or Pedestrian Scale Lighting (3-5 M Tall) – illuminate pedestrian-only walkways and provide supplemental light for the sidewalk.
2. **Different Types of Street require Different Types of Street Lighting.** Approx. 30 lux level is suitable for non-shopping areas and 20-25 lux-level for shopping areas.
3. **Key aspects of planning for Optimum Street Lighting are:**
 - **Evaluation of adjacent landuses.**
 - **Evaluation of activities (especially night-time activities)** on the street. For example, lighting requirement outside Old Delhi Railway Station would be very different from that outside Millennium Park.
 - Street Lighting must not pollute the environment, i.e. **no night sky light pollution. See 08B**
 - **Energy Efficient fixtures** should be utilized that give good value for money, i.e are durable, rugged and inexpensive.
 - **Concentrated lighting** is required at all road Intersections and junctions, as well as bus stops, Metro exits, near crosswalks, street furniture, public amenities and important signage.
 - While placing street lights, ensure adequate gaps and **spacing from the tree canopies** to ensure that performance of lighting is not compromised.

08A Pedestrian Scale Street Lighting

Best Practices



- **Height of Light Pole is a function of Street Width. Narrower the Street Width, lower can be the Lamp Height.**
- Expert advise should be taken from lighting engineer for design calculations including for pole height, type of luminaries, etc. for achieving appropriate lighting levels at all parts of the street.



Street Lighting Fixtures also help define the unique character of an area.

High/ Mid-Mast Lighting may not provide sufficient light at pavement level.

Additional Low-Mast Pedestrian Scale Lighting is advisable on all Streets.

30 M or narrower streets like local access lanes, alleys and pedestrian pathways can possibly be adequately illuminated with Low-mast fixtures alone.

Above: A historical neighborhood
Below: A modern area – both in San Francisco

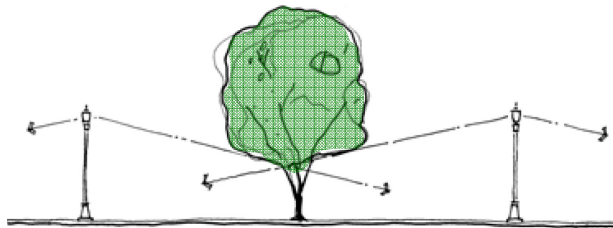

- **Tree planting plan and Lighting plans (See also 04A) must be prepared in conjunction** – so that tree canopies do not obstruct lighting for road users.
- Under NO CIRCUMSTANCES should the **Light-pole placement interfere with the clearance of the main pedestrian walkway** of the pavement. Light pole may preferably be located within the tree-planting zone.

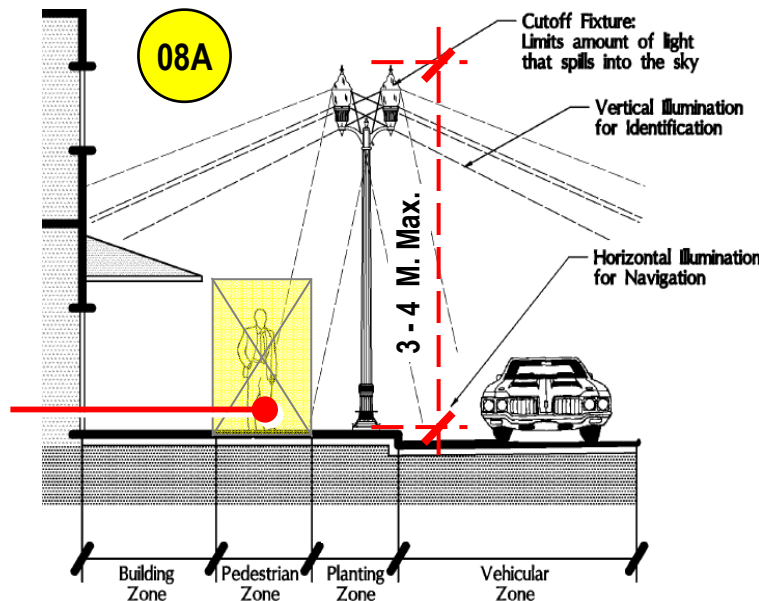

Source: San Francisco Better Streets Plan

Not Preferable



Non-cutoff Street Lights often cause glare and night pollution.

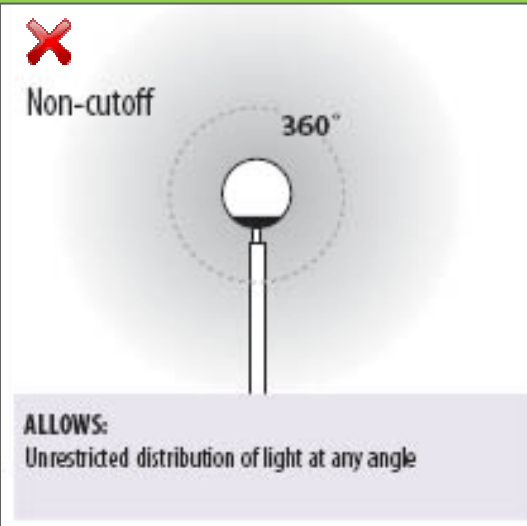

08B Full Cut-off Light Fixtures

Intent:

- Provide Ambient Street lighting for pedestrians without causing glare, over brightness or light pollution.

Key Design Guidelines:

- **Full cut off fixtures** which focus light downwards and allow no light towards the night sky, and also do not cause glare – are required for all public streets.
- Lighting shall be directed downward at all times (**up-lighting would be prohibited**)
- Over-lighting an outdoor area at night is NOT the best solution for security or safety. Instead, exterior lighting that provides **low contrast on critical areas** improves visual acuity and safety.
- The light color of lamps also affects safety: illuminating objects with products that have high Color Rendering Indexes (CRI) improves visual recognition at night.
- **All exterior lighting shall have shielding as per table below.**

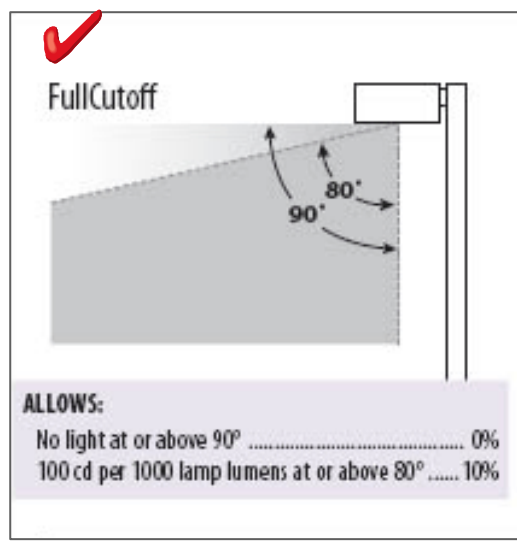
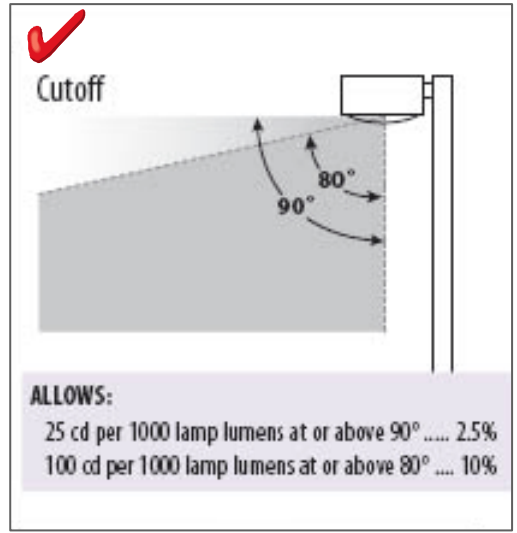

Fixture Lamp Type	Residential Area Shielded	Commercial/Industrial Area Shielded
Low Pressure Sodium	Fully	Fully
High Pressure Sodium	Prohibited except fully shielded on streets	Fully
Metal Halide	Prohibited	Fully
Fluorescent	Fully	Fully
Quartz	Prohibited	Fully
Incandescent > 60 Watts	Fully	Fully
Incandescent 60 Watts or less	No requirement	No requirement
Glass Tubes filled with Neon, Argon, or Krypton	No requirement	No requirement
Mercury Vapor	Prohibited	Fully
Halogen	Prohibited	Fully
Searchlights for advertising purposes	Prohibited	Prohibited

08B Full Cut-off Light Fixtures

A variety of Full Cutoff light fixtures can meet required site-specific standards:

08B

Solar LED lights

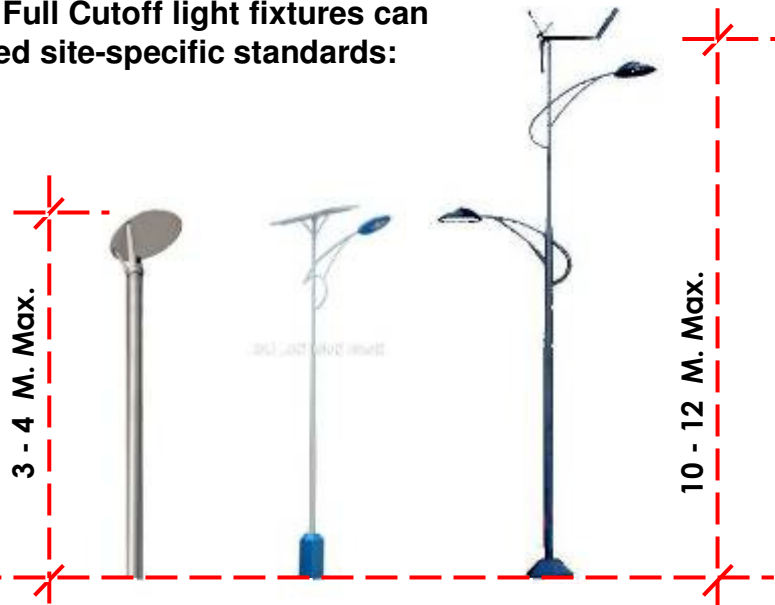

•For Wide Streets with high pedestrian/ commercial activity, **Mid-Mast lighting** may be combined with **Pedestrian Scale lighting** to create adequate sense of security and comfort.



Graphic Source:
www.winslowwaystreetscape.org/WinslowWayStreetscape/Final_Design_files/Lighting_finalDesign.pdf

Best Practices

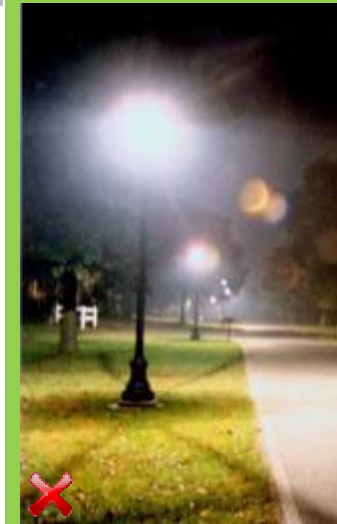

A poor quality light fixture causing glare and night pollution.



Uniform low ambient levels of lighting provides better visibility for pedestrians.

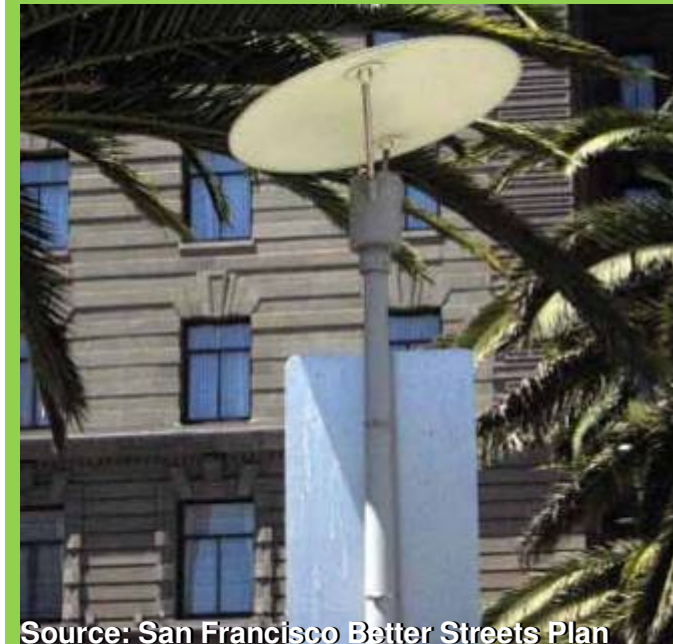

Source: San Francisco Better Streets Plan

Downward-facing lighting prevents excess light from trespassing into adjacent buildings

This page is intentionally left blank.

09 Urban Utilities

- 09A Underground Utilities
- 09B Common Utility Ducts
- 09C Duct Banks



Careful location and planning of Physical Infrastructure services and Urban Utilities is critical – in order to allow easy access for regular repair and maintenance of utilities, while causing minimum disruption or disturbance to other street users.

URBAN STREET UTILITIES INCLUDE:

- Electrical Cables (HT/LT)
- Road Lighting Cables
- Communication Cables
- Cable TV
- Tele/Broadband Cables
- Traffic Signal Cables
- Gas Lines*
- Water Supply Lines*
- Unfiltered Water/Irrigation Lines*
- Drainage Lines**
- Sewerage Lines**

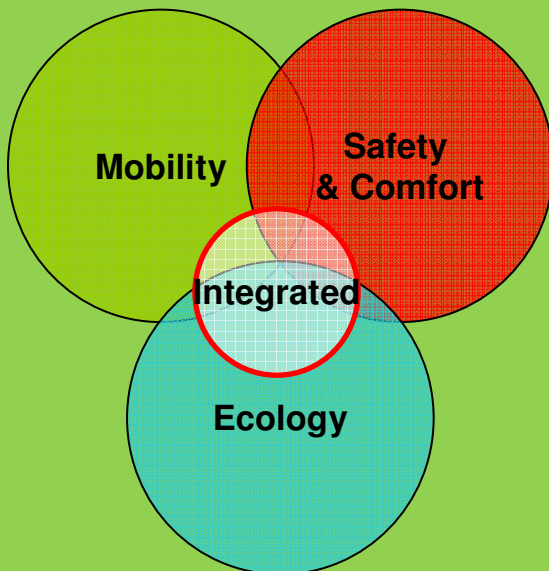



Utilities on Footpath



Open Manholes on footpath



Dug up footpath during Utilities Repair

Careful location and planning of services is important in order to cause minimum disturbance to street users during repairs and maintenance of utilities.

- The street is also a carrier of urban utilities such as water lines, sewer, electrical and telecom distribution cables, gas pipes, etc. these must be located underground and in some cases over ground in a proper manner.

Key Design Guidelines:

- Placement of services which require access covers should **not be done under the NMV lane** as the covers tend to disturb the cyclists ride quality.
- **Indian and international standards are available for spacing between the various services. These should be followed.**
- Locations should be decided after accounting for all the different utilities to be placed in the street. Individual utility providers should get the locations and routes approved.
- Dense urban areas such as Shahjahanabad could consider providing **Common Utility Ducts** for carrying the services. This will prevent periodic digging up of roads for maintenance.
- Utilities must be placed in a neat and tidy manner. Poorly installed services make the city look ugly.
- It would be prudent to **leave pipes under the footpath to provide cabling and services in the future.** This will help avoid unnecessary digging and damage to the pavement and road surfaces.

Typical drawings are shown on the following page.

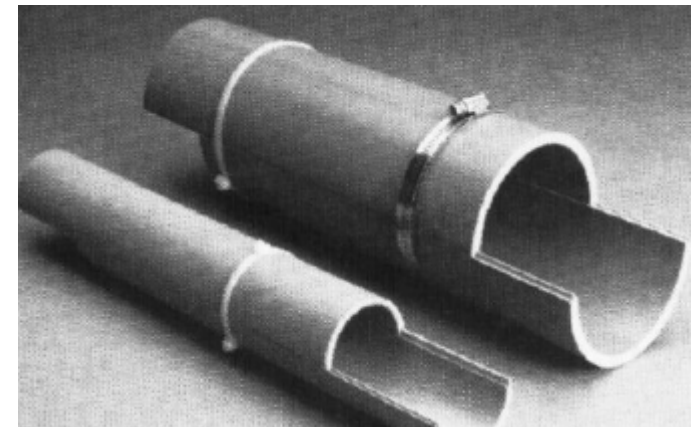

Split Ducts can be used to accommodate existing services during repairs and add future ducts for gradual upgradation.

09A Underground Utilities

Best Practices

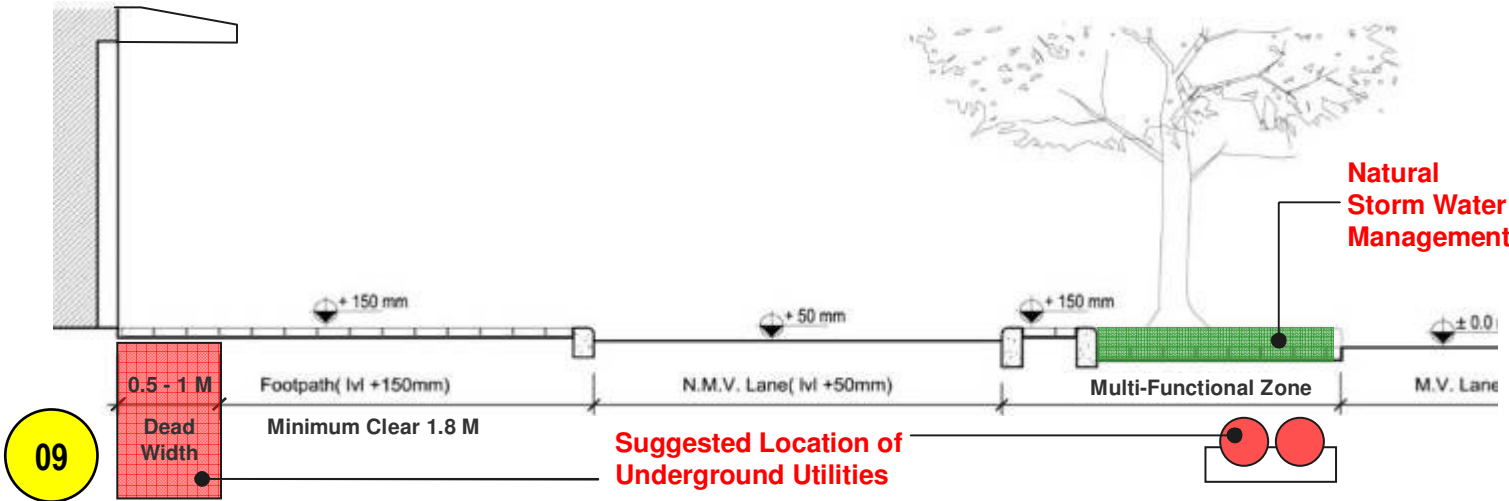

Utilities along the 0.7 M Buffer Zone between Cycle Path and MV Lane, BRT corridor, Delhi.

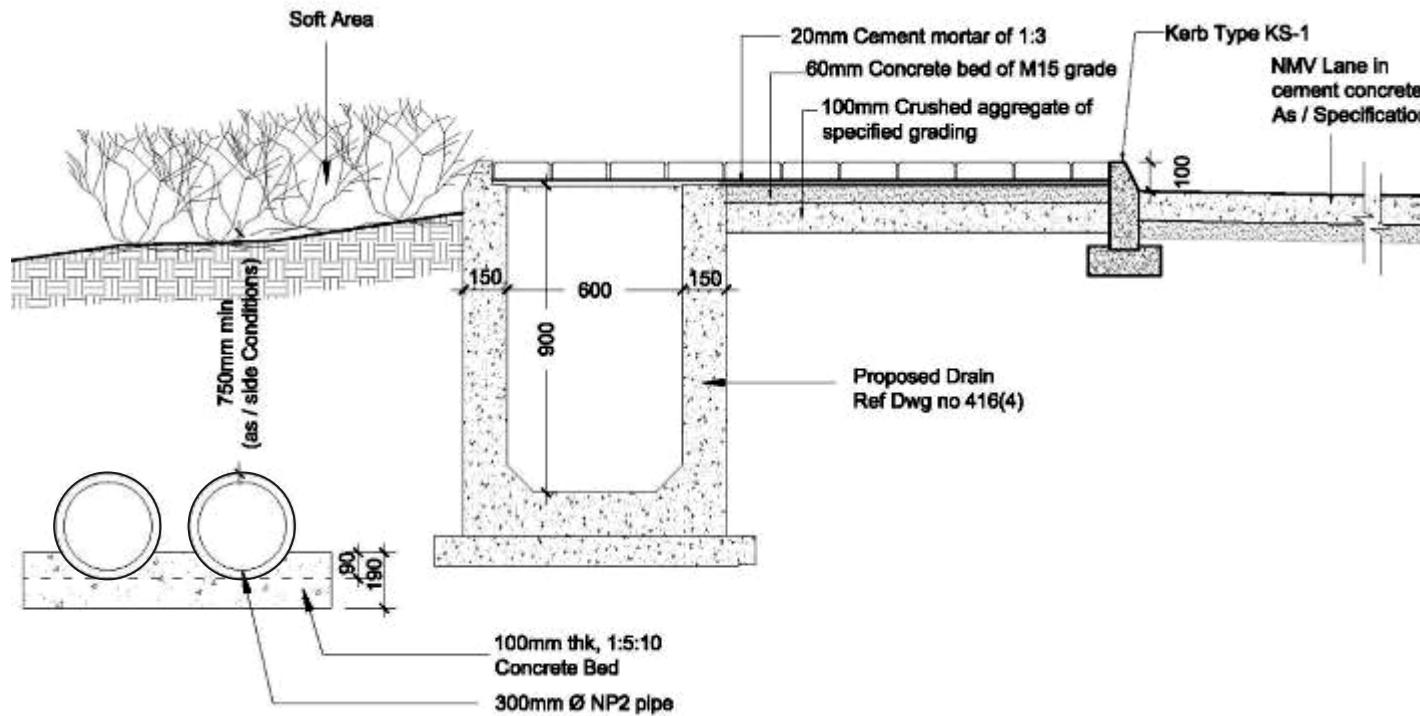

Sample Underground Cabling Plan

Drawing Courtesy: Pradeep Sachdeva Design Associates

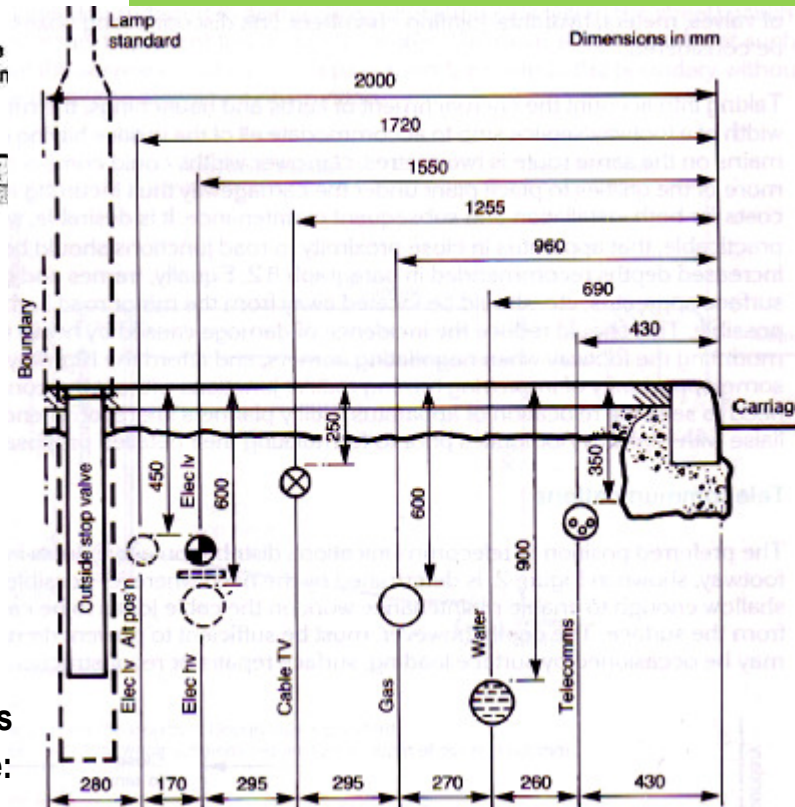

British Services Layout Guideline:

Best Practices

Common Utility Ducts can be integrated with future MRTS (Metro/BRT) projects.

- This will help optimize construction costs and time for provision of future utilities.
- It will allow for planned future redevelopment, densification or new development along MRTS corridors.



Xinyi and Songshan MRT lines in Taipei, Taiwan, have incorporated common utility ducts into their designs.

*Source: Dept. of Rapid Transit Systems, Taipei

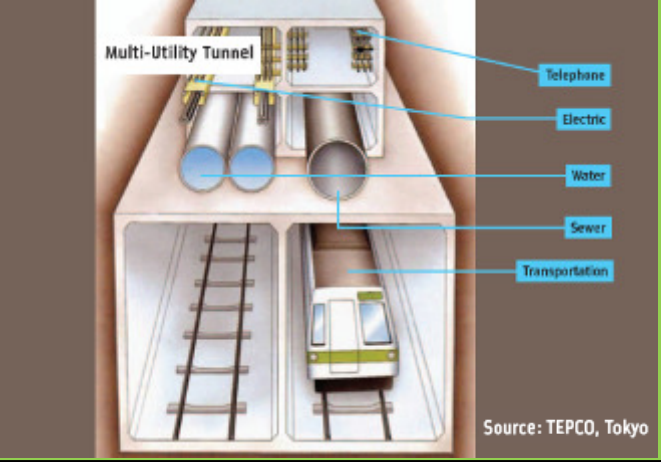

Source: TEPCO, Tokyo

09B Common Utility Duct (“CUD”)

A Common Utility Duct (CUD) is a form of structure, above or under ground, which contains more than two types of public utilities, and includes its own drainage, ventilation, lighting, communication, power, monitoring systems, and so on. The advantages of such facility are the reduction of maintenance manholes, accurate positioning of manholes, one-time relocation, and less excavation and repair. It helps keep roads smoother. The set up of common utility ducts will significantly raise the quality of life and reduce social costs.*

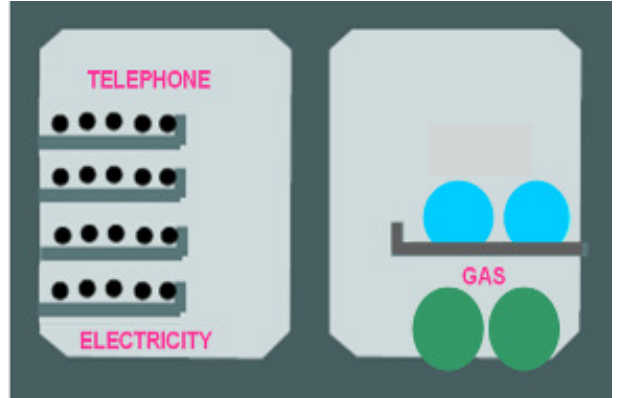

Rectangular CUD with or without partition (accessible through Manholes)

Advantages of a CUD:

- Maximum efficiency of underground space usage.
- Decreasing above ground construction that can disrupt traffic; Keeps road/sidewalks Smoother.
- One time relocation and less future excavation and repairs.
- Allow rapid access to all utilities without having to dig access trenches due to confused and often inaccurate utility maps.
- Easy and quick access to utilities after major natural disasters like earthquake etc.
- Public safety & increase the quality of life and reduces social cost.

Limitations of a CUD:

- Extremely expensive. In old/ already built-up areas, cost of shifting/ relocating Existing Services is huge. However, huge savings can be made annually on road/ pavement resurfacing after utility repairs.

Sewer/Drainage lines not laid in CUD because:

- Sewer / drainage lines run by gravity so cannot be controlled. To control the flow into the main sewer / drain lines large numbers of valves are required, which need heavy maintenance. Other services provided in the corridor can be controlled by main control centre and can be switched off in emergency.
- Leakage in sewer line may lead to foul smell inside the service corridor.
- Size of duct would be much bigger.

Key Design Guidelines:

- Indian and international standards are available for spacing between the various services. These should be followed.
- Use of cement concrete should be kept to the minimum requirement. Gravel, Sand, soil etc. is preferable as filling.

09B Common Utility Duct ("CUD")

Best Practices

Fully Accessible Duct (accessible through Entrance Chambers)

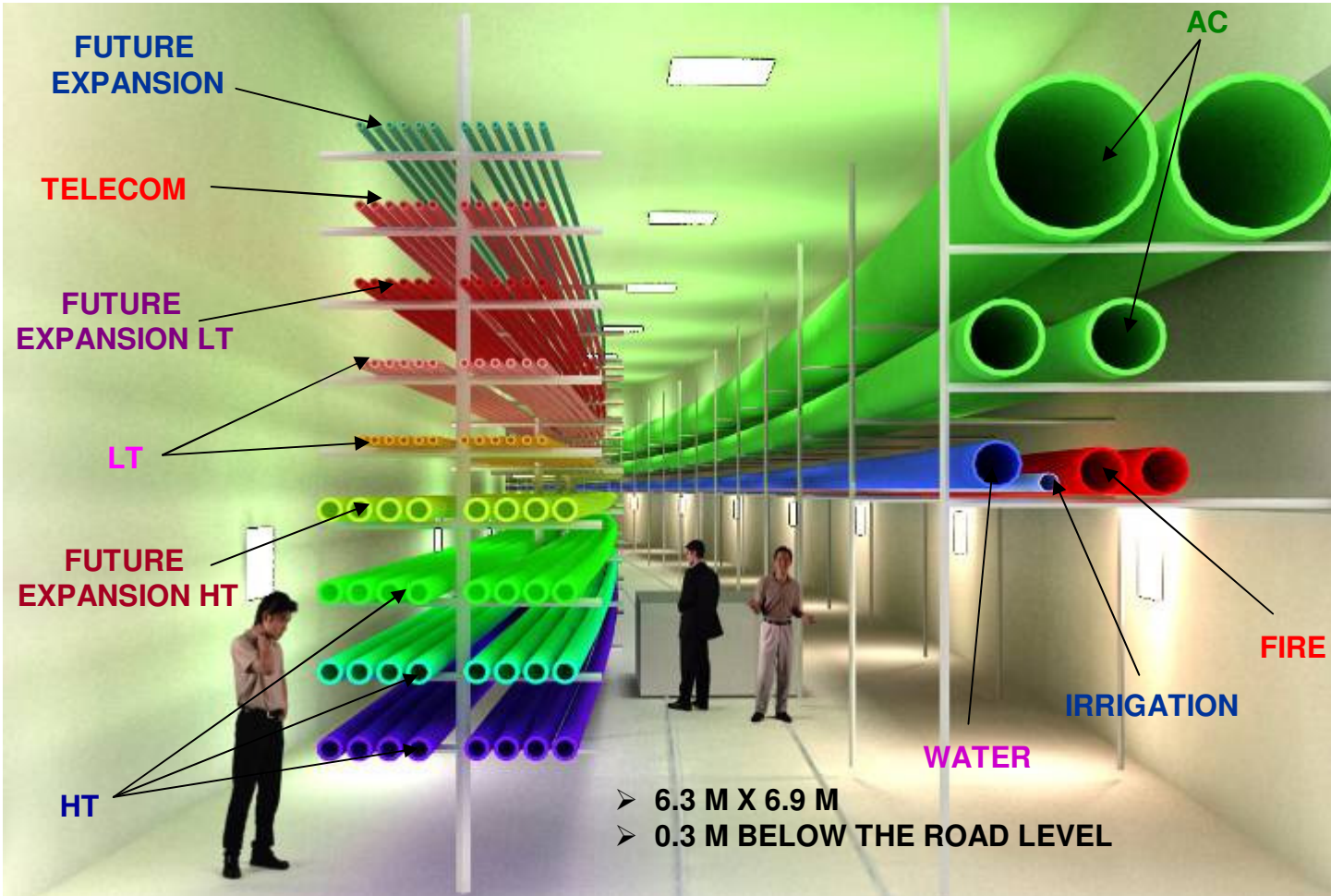

View of fully accessible CUD proposed in Connaught Place by NDMC, June 2009

Placement Norms for all 3 Types of CUDs:

- Complete primary & secondary voltage can be laid in u/g duct system.
- Manholes aligned parallel to street to facilitate conduit installation.
- Duct bank straight & should drain into manholes.
- Duct banks to contain pull cords
- Plugged with tapered plastic plugs to prevent entry of debris.
- Diameter of duct pipe : 1.5 x od of cable : 2 x od of gas pipe

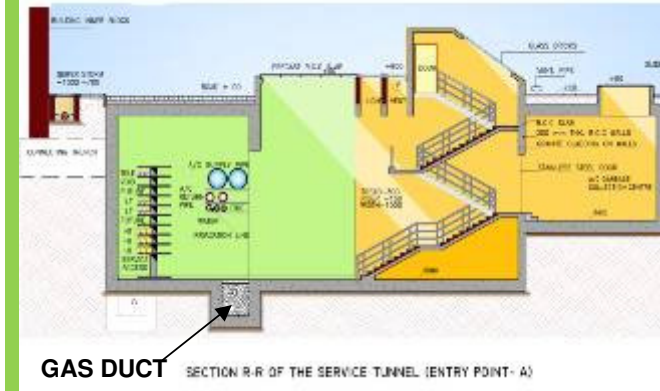

Section through Service Tunnel of CUD proposed in Connaught Place by NDMC



Sketch of a Fully accessible CUD with respect to the Street above.

Duct Bank is an assembly of pipes/ conduits which may be encased gravel or soil with intermittent spacers placed over a Concrete Bed, or encased fully in concrete. Ducts banks are placed in excavated trenches which are accessible through manholes provided at required intervals.

Placement of sewage and water pipes is not preferable within Duct Banks.

Red Danger Tape should be placed at the top of the gravel/ earth filling of the Duct Bank pit in order to warn future excavators of the existence of a Duct Bank below.

Duct Banks should not be placed in the Multi-functional Zone (MFZ) as tree roots may create interference.



“Chairs” maintain spacing between electrical ducts.



Backfilling the north-south portion of the 5kV electrical duct bank, west of Dupuis Hall

Danger Tape warns future excavators an electrical line is below

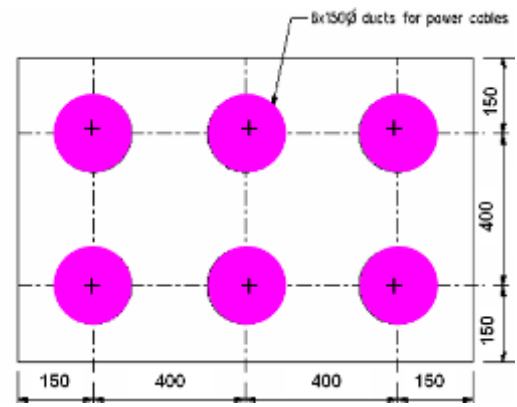

For power cables

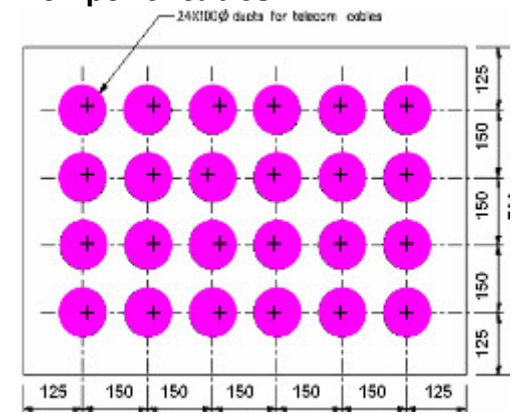

For Telecom cables

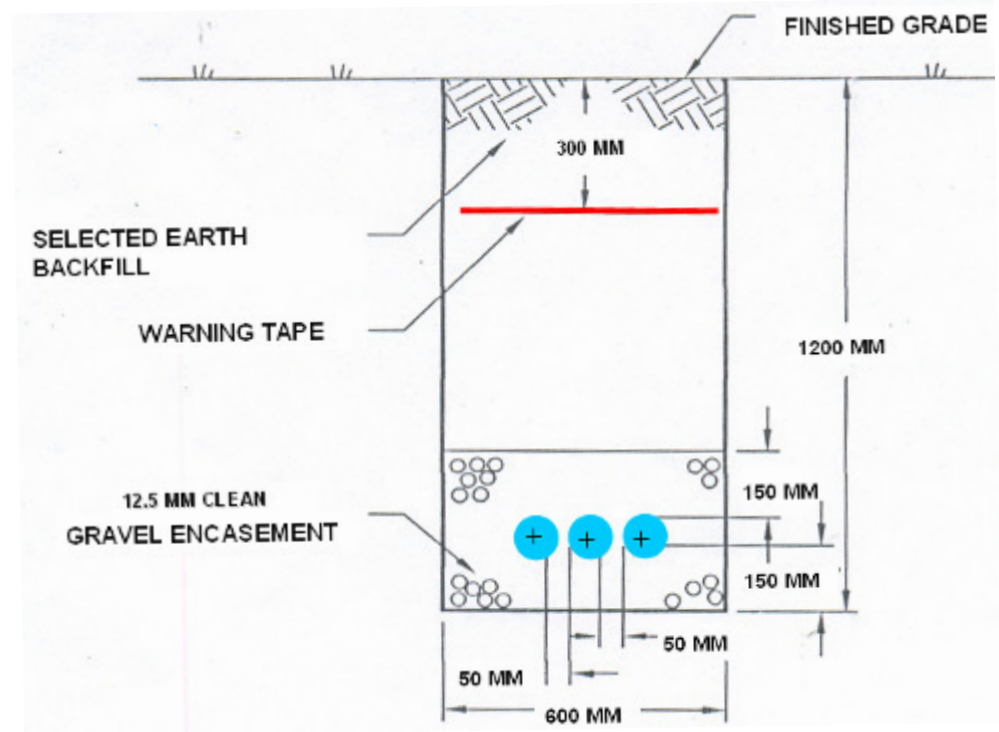

Above:
Sample Detail of a Gravel encased Duct Bank

10 Public Amenities, Hawker Zones, Signage

- 10A Local Bus Stop
- 10B Public Toilets
- 10C Street-Direction Signage
- 10D Pelican Signals
- 10E Dustbins
- 10F Hawker Zones



Sulabh Shauchalaya



Street Names



Hawkers



Streets must accommodate all amenities and facilities needed day to day by pedestrians, cyclists or transit users on Delhi's streets; as well as general Delhi citizens.

In addition, streets are portals for other city level outreach, advertising and public service initiatives that can be provided for citizens with minimal effort...

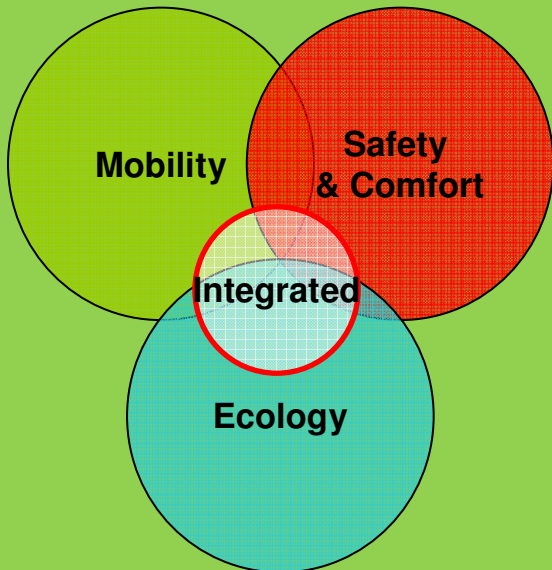

10 Public Amenities, Hawker Zones, Signage

The Kit of Parts:

Designated Hawker Zones (10G) must be allowed to locate in areas where pedestrians tend to wait or congregate i.e. street intersections and near bus stops or major civic destinations, public offices, etc.

X. Public Toilets (10A) should be located near every alternate bus-stop and definitely located at each Rapid Transit Station (Metro/BRT). Frequency of location of toilets should be every ~500 - 800 M.

Y. Bus Stops with Route Maps (10B) must be universally accessible, and located every ~800-1000 M.

Z. Auditory Pelican signals (10C) and raised **table-top crossings** at all mid-block or T-junctions, in absence of a full traffic signal.

Auto and Cycle-Rickshaw Stands (04) should be provided near bus-stops, within the Multi-Functional Zone.

“Set of 3” at every intersection must be provided for **Pedestrian Way-finding:**

1. - **Dustbin with map** (10E)
2. - **Street directional signage** (10D)
3. - **Universal accessibility features** (03B)

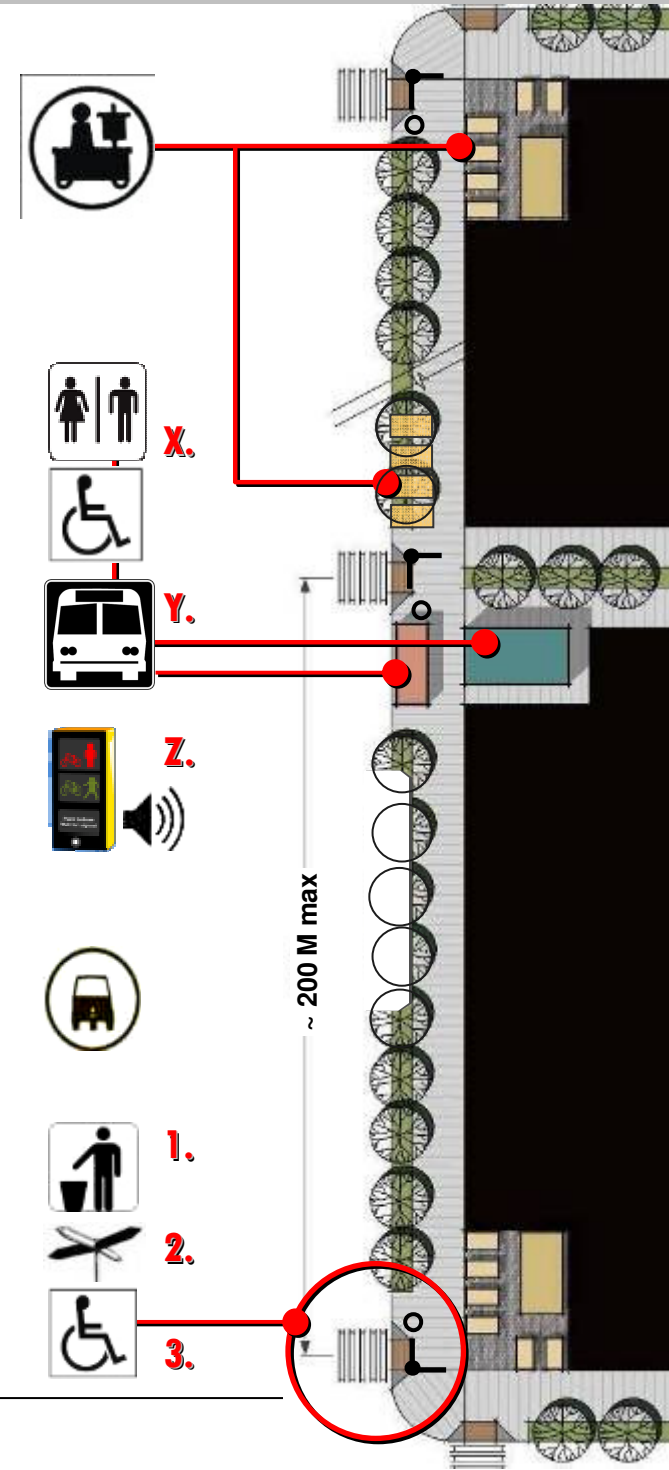



10A Local Bus Stop

Key Principles:

- Dustbins – their frequent provision, cleaning and maintenance are key aspects to the cleanliness of a city.
- **All bus stops must be universally accessible.**
- Bus Stops should preferably be located within the **Multi-Functional Zone** – so that they do not interfere with the **1.8 M clear walking zone** for passing pedestrians at the back.
- **Criteria for Placement of Local Bus Stops:**

Placement of Stop

- Convenient location to major land uses (pedestrian generators)
- Convenient to transfer movement

Pedestrian Access

- Route to be direct as possible, integrating short-cuts
- Connecting path should be clear of obstructions, firm surface material, well drained
- Consider impact of stops on adjacent properties
- Adjacent, or as close as possible to stop going in the opposite direction
- Accessible stops should have matching adjacent stops
- Convenient for errand running and "trip linking" tasks
- Grade of road should not impede accessibility

Visibility

- Drivers' sightlines should not be obscured by trees, shrubs, poles, buildings
- Where there are bike lanes: locate sufficient distance for cyclists to stop safely
- Buses should not restrict visibility of traffic signals
- Do not place on curves
 - 150 m. sightlines going into zone and coming out of zone
- Ensure clear sightlines on the right side of the bus - no obstructions
- Stop should be well lit

Proximity to Crosswalks

- Intersection stops: if near side is necessary, ensure 4.5 metres distance
- Mid block stops: always locate stop on far side of crosswalk so that pedestrians **cross from** behind the bus not in front
 - Avoid locating stop close to driveways especially those with high traffic volumes

Driveways

- If impractical, ensure full visibility for vehicles exiting driveways
 - Place on far side of driveway (sight distance for left turning still a problem)
- Consider volumes and turning movements of other vehicles

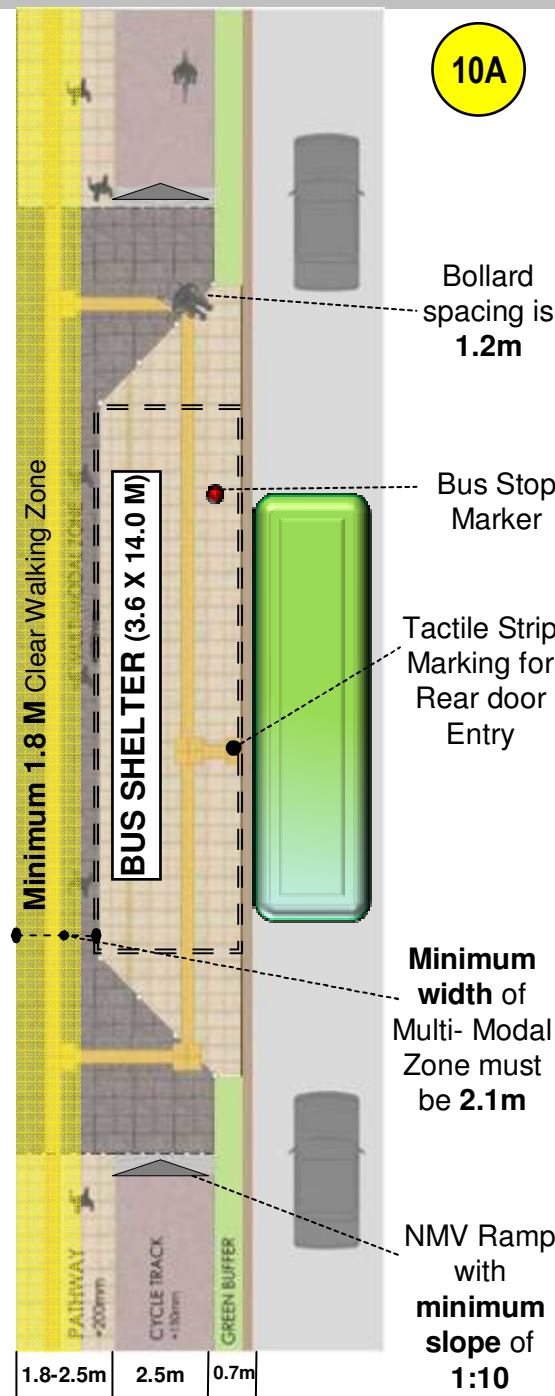

This Bus Stop is accessible, but Clear 1.8M Pedestrian Zone has not been left. Moreover, Space in front of bus stop for waiting passengers is highly inadequate.



This Bus Stop is correctly placed.

A Local Area Map or an entire **Bus-Route Map** should be displayed on the panels of all bus-stops (besides advertising), to help Wayfinding.



Key Guidelines:

- **Provide public toilets at a distance of every 500 – 800 M** (5-8 minute walk) from each other and from any destination.
- Toilets should be located near **every alternate bus-stop** and **at each Rapid Transit Station** (Metro/BRT)
- Public toilets should be provided as combination of general toilets and accessible toilet, where accessible toilet to be marked as Multi-use toilet to be used by senior citizens, families with young children and disabled persons.
- **Environmental friendly Sulabh Shauchalayas** should be built as public toilets as they have the following **advantages**:
 - They do not smell
 - They consume very little water and are easy to clean and maintain (in contrast to conventional toilets that require a minimum of 10 litres.)
 - They have potential to tie up with other community based environmental technologies such as biogas production, etc. for heating, cooking, and generating electricity.
 - They provide new employment opportunities for many.
 - Environmentally balanced wastewater treatment based on a duckweed and fish raising (pisciculture) ecosystem that provides economic opportunities for the urban poor.

Lack of adequate clean and frequent public toilets and abundance of unwatched boundary walls makes Delhi's public spaces an open public toilet.



(Above) Sulabh Shauchalayas

(Right) A public toilet system that incorporates local treatment and water recycling system – providing much needed water for horticulture.

Source: Pradeep Sachdeva Design Associates, 2009





Obscure Street Signage.....



Key Principles:

Signage for Wayfinding and Information of Pedestrians and Cyclists are essential for creating a public transport friendly city.

Signage provides help to pedestrians to navigate the city with ease and safety, and have the following functions:*

- **Orientation – Way finding** (Street Signs)
 - **Availability of Public Transit nearby** (Transit Signs)
 - **Guiding Street Flow** (Traffic Signs)
 - **Announcing about City's specific features or attractions** (Information Signs)
 - **Conveniences** (Toilet, dustbin, hawker signs).
- Signs should reinforce the overall character of the specific district and be consistent throughout the City.
- Posts and poles should be arranged to minimize the number and avoid clutter.



Pleasing Signage Palette above. But Non-Vector Signage is ineffective for Wayfinding.



Visual Signage is preferable for Amenities and General Information

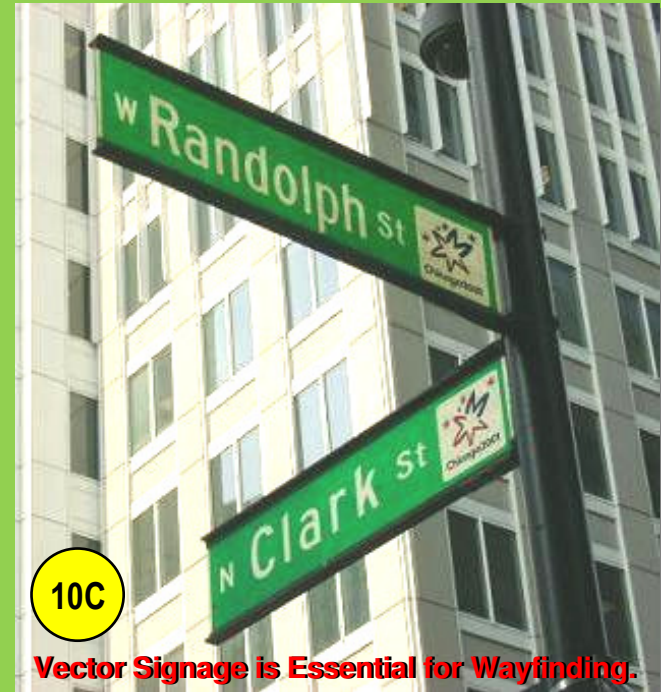

Vector Signage is Essential for Wayfinding.



*Source: San Francisco Better Streets Plan

Not Preferable

Delhi has very large block sizes. This provides limited permeability for pedestrians and makes them difficult to easily reach Destinations on the opposite side of the street after alighting from a bus or train... thus forcing them to jaywalk and risk their lives.



At the same time, aggressive Delhi drivers do not stop at designated pedestrian priority STOP signs, unless it is a signalized intersection...



10D Pelican Crossings



Key Principles:

- Pedestrian initiated traffic lights may be installed at mid-block crossings to make traffic stop for pedestrians, cyclists and the physically handicapped.

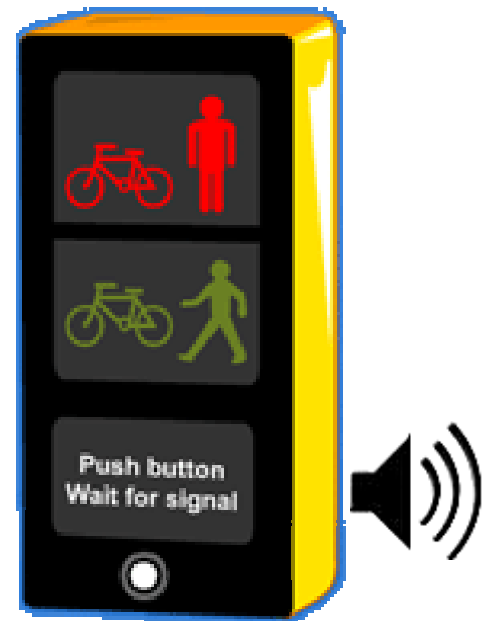

Auditory Pelican Signal

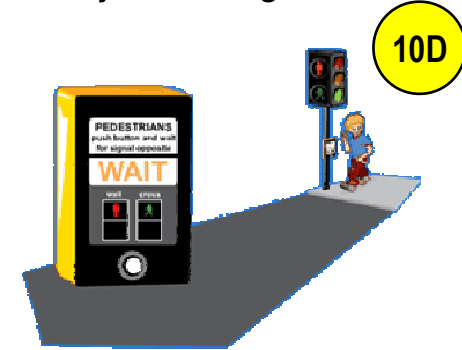

You must push the button to stop the traffic

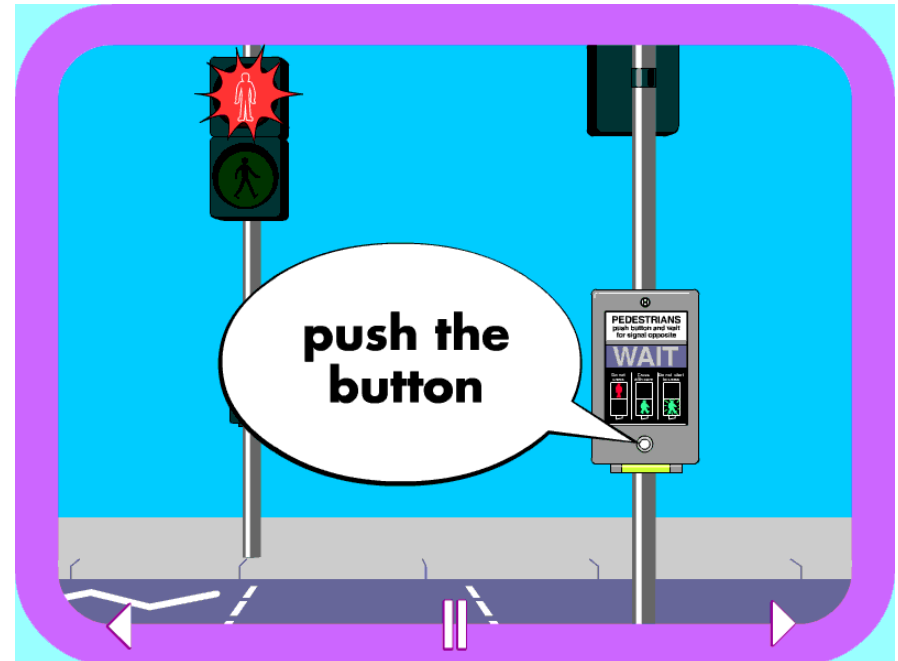

How to Use a Pelican Crossing? – A Road Safety Education Feature on the Northern Ireland Road Safety Website.
Source: <http://www.roadsafetyni.gov.uk/>

See Also:

- 03B Raised Table-Top Crossings
- 06B Mid-Block Crossing

Not Preferable

10E Dustbins



Best Practices



Littering in Delhi is a perennial problem.
Source: Hindustan Times, Oct 2009

Key Principles:

- Dustbins – their frequent provision, cleaning and maintenance are key aspects to the cleanliness of a city.
- **Dustbins must be provided at each bus-stop and street intersection** in order to discourage people from throwing trash on the road.

Key Concepts:

- On Source Separated Dustbins – **signage for “Trash type” should be made of graphic symbols** – so that even illiterate people can understand how to use them.
- **Private Sector could be involved in manufacturing and maintenance of dustbins** in return for the incentive of getting waste for recycling or tax subsidies for firms if conducted as a CSR initiative.



Transparent dustbins can be used in crowded places like Metro Stations, etc.



“How to use” Delhi’s new ‘source separated’ dustbins is a mystery to most people in the city.



“Graphically explained” Source Separated Dustbins: Shanghai.



Opaque Dustbins with Maps - can be use at general Street corners and Intersections.

*Graphics Source: Miscellaneous, representative only.

Not Preferable

10F Designated Hawker Zones



Hawkers or “micro-entrepreneurs” provide a wide variety of services and amenities to people, at convenient locations – with negligible investment and infrastructural costs.

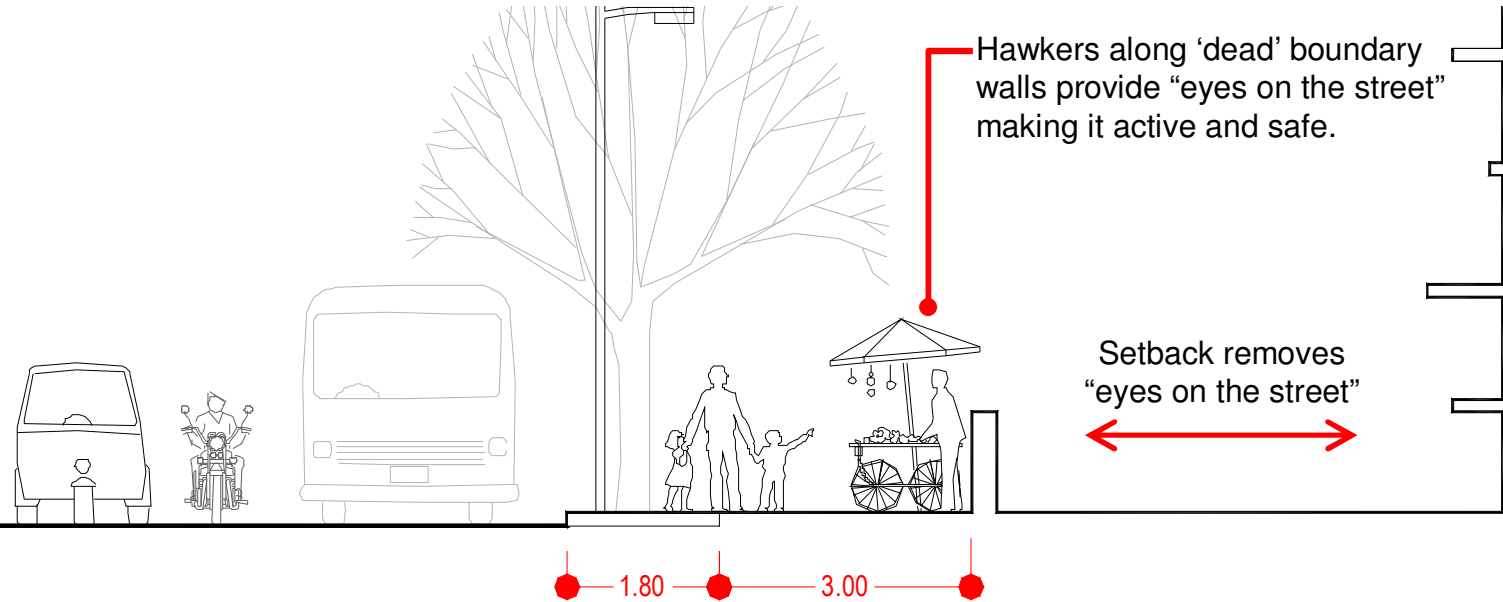

Hawkers must be given designated space within the road Right-of-Way, so that they don’t occupy the Minimum Clear 1.8 M Pedestrian Walking Zone.



Benefits of Hawkers in Street-space:

- They keep streets busy, vibrant and safe.
- They provide a variety of cheaper food and retail options.
- They infuse mixed-use and encourage walk-trips in a city planned predominantly based on private-vehicle use.
- They generate self-employment for a large number of people.



Organized Hawkers



Organized Food Stalls, China



Organized Food Stalls, Beijing



Organized Food Hawking



Organized Hawking, London



Organized Hawking, Mumbai



Connaught Place, New Delhi



Fashion Street, Mumbai

Hawkers must be given designated space within the road Right-of-Way, so that they don't occupy the Minimum Clear 1.8 M Pedestrian Walking Zone.

Designated spaces will make enforcement easier which has not been possible so far.

Key Principles:

1. **Hawkers MUST be accommodated within the Road RoW – approximately every 500-1000 M on a public street.**
2. They are needed at all commercial centers and must be at walking distance from offices, homes and retail areas.
3. Flexible Hawking Zones can be accommodated within the Multi-Functional Zone described in Section 04.

4. Essential Utilities also must be provided as outlined in the **NATIONAL POLICY FOR URBAN STREET VENDORS:**

- a) Provide provisions for solid waste disposal
- b) Public toilets to maintain cleanliness.
- c) Aesthetic design of mobile stalls/ push carts
- d) Provision for electricity
- e) Provision for drinking water
- f) Provision for protective covers to protect their wares as well as themselves from heat, rain, dust etc.
- g) Storage facilities including cold storage.

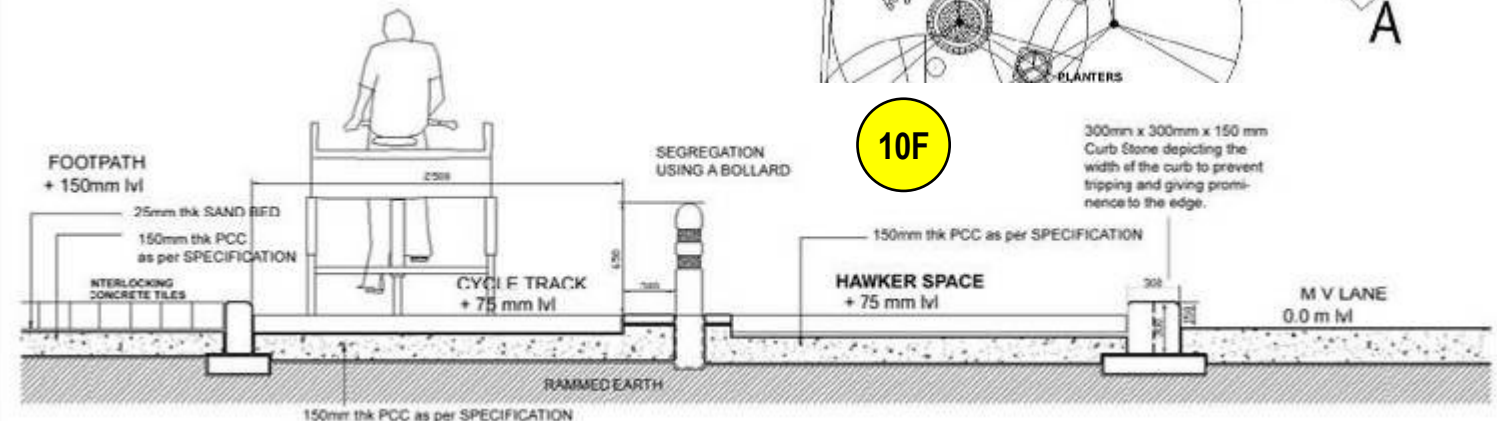
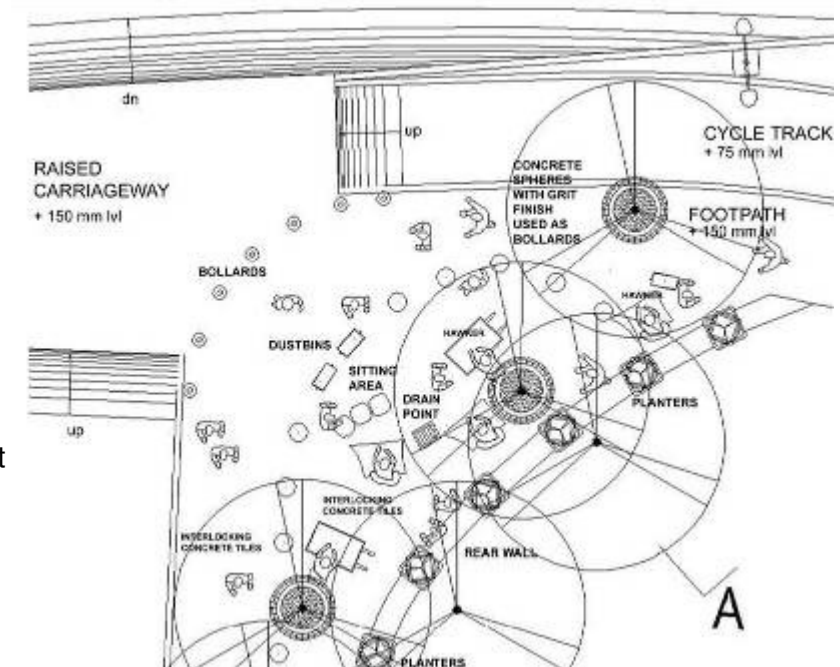

10F



10F Designated Hawker Zones

Best Practices



San Diego

A

Hawker zones at Street Intersections



New Market, Kolkata

B

Hawkers fronting Shops

1.8 M clearance for moving pedestrians

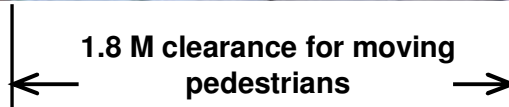

In Columbia



In Beijing

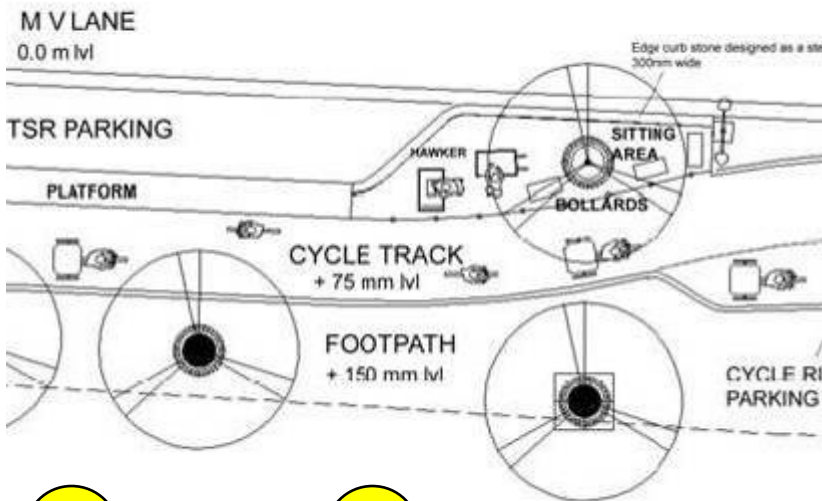

CP, Delhi

C

1.8 M CLEAR Walking Zone

Hawker zone on pavements



In New York

10F See Also: **04**

This page is intentionally left blank.

6. Design Toolkit: Additional Components



11 Traffic Calming Measures

- 11A = See 01D Kerb Radius and Slip Road Treatment
- 11B = See 03B Raised Table-Top Crossings and Driveways
- 11C Paving Variations at Crossings, Stop Signs, Intersections
- 11D Pedestrian Dominated “Kerbless” Streets
- 11E Chicanes
- 11F Mini Traffic Calming Circles
- 11G Full Closures



Traffic Calming is the management of traffic – through a combination of Education, Enforcement and Engineering devices – so that its negative impacts on residents, pedestrians and schools is minimized.

The goal of traffic calming is to reduce vehicle speeds, improve pedestrian and cyclist safety, and enhance quality of life.

Signal free and fast movement of motorized vehicles *within city limits* (other than Mass Rapid Transit Systems) is to be minimized, as this makes the city extremely unsafe for pedestrians and public transport users and causes fatal accidents.

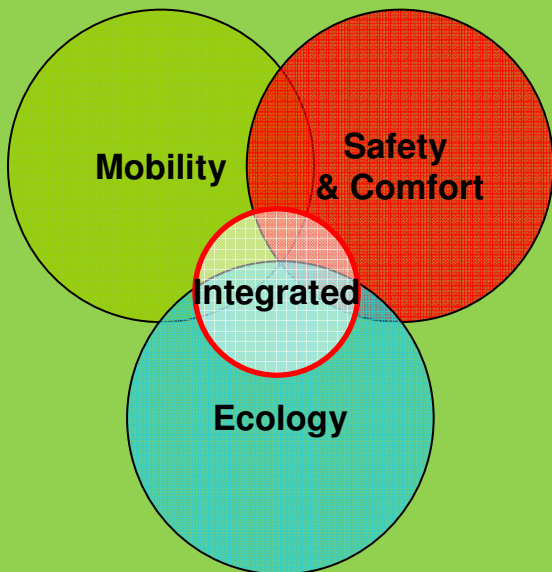

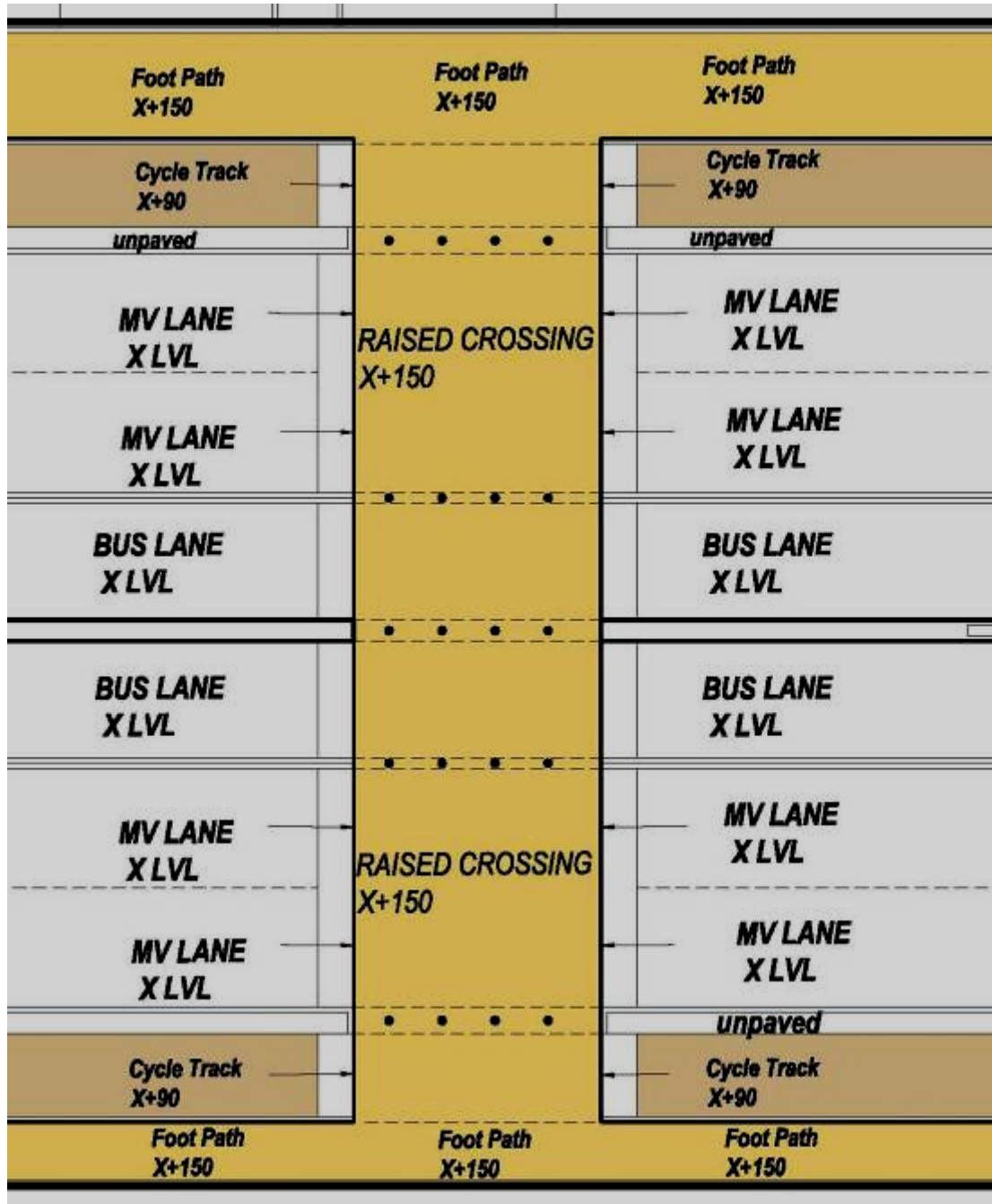

Only Anti-Skid, uniform materials to be used on Tabletop Crossings – for comfortable access by people with reduced mobility.



See also:



Table-top Crossings slow down traffic at Intersections and Mid-block Crossings – allowing pedestrians & cyclists to cross safely

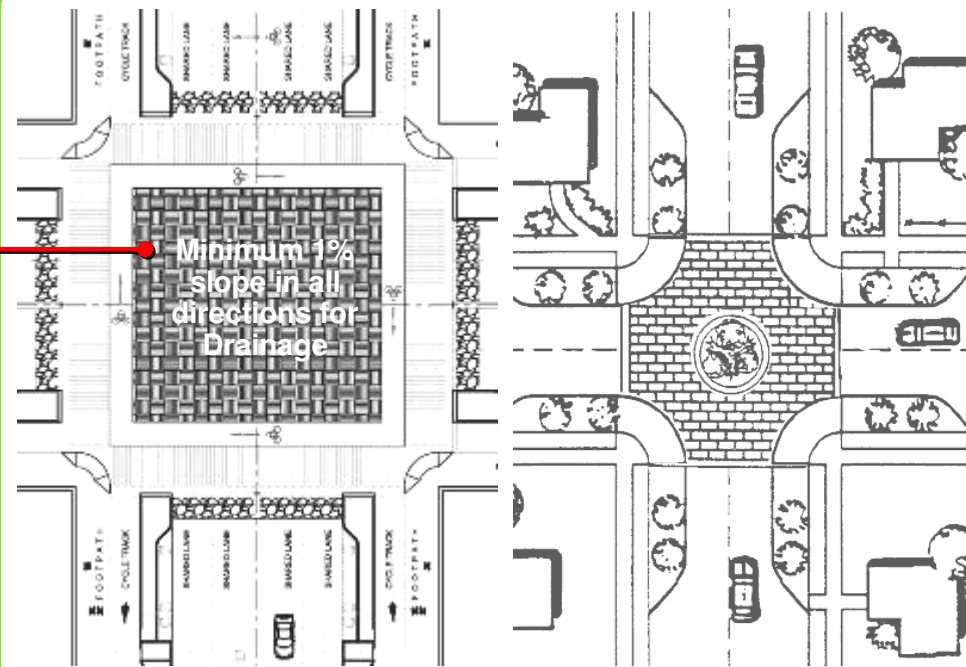
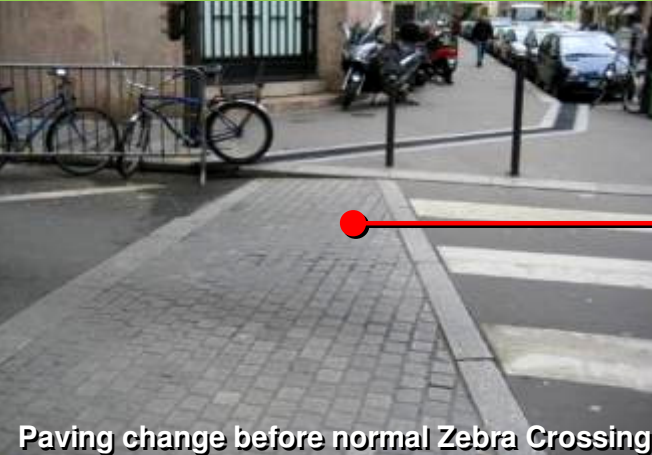

Raised or Paved Plazas (or “Chowks”) at Intersections induce traffic to slow down while turning – making them watch out for crossing pedestrians and cyclists at the intersection.

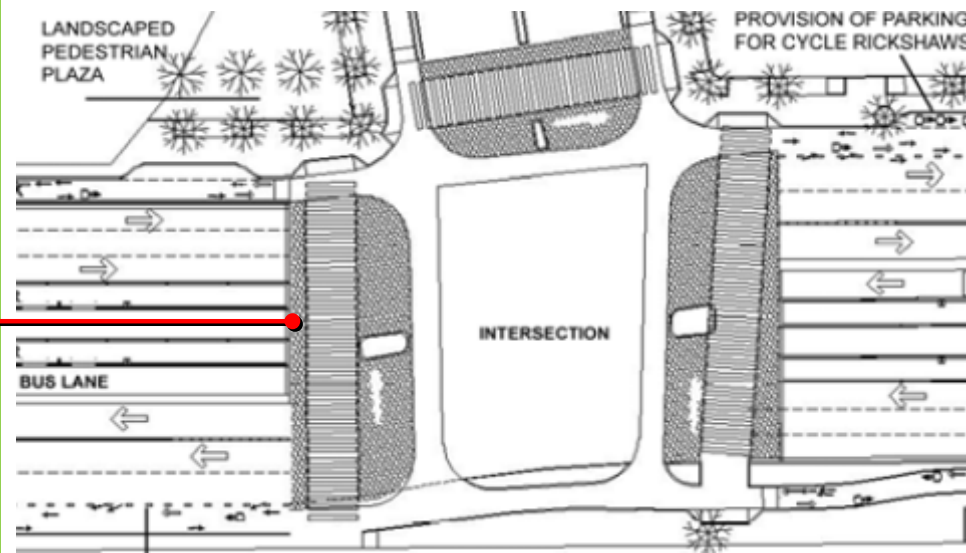

Use of continuous Paving Materials or Colors at Crossings – provides visual continuity to Pedestrians and also makes crossings clearly visible to drivers from a distance.

11D Pedestrian Dominated: Kerb-less Streets

Best Practices

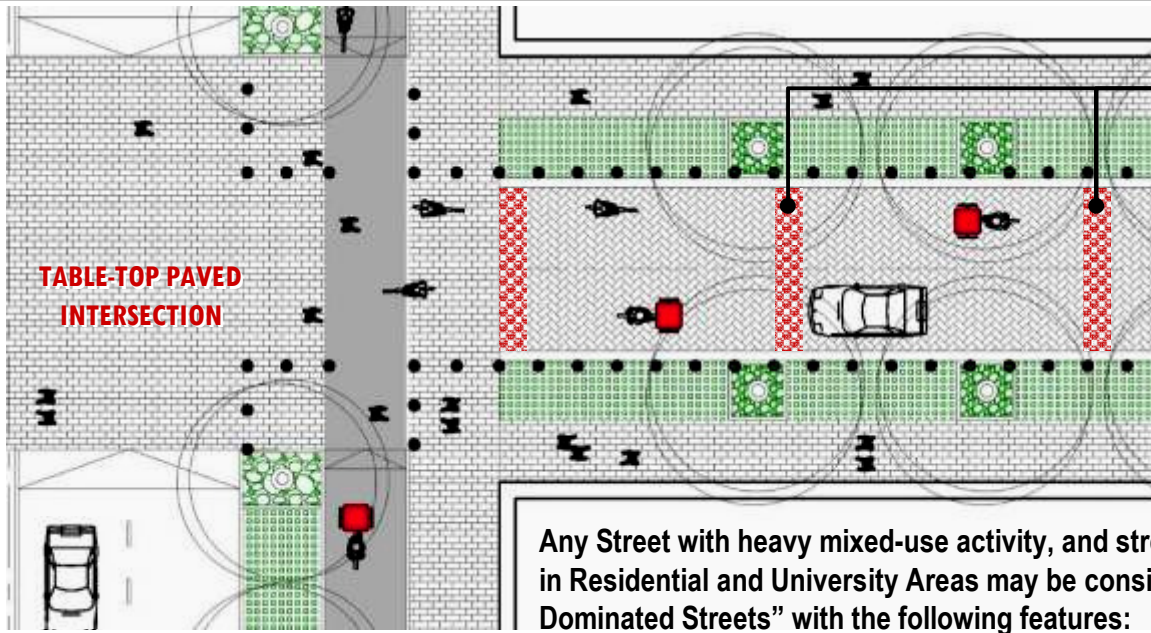

- These streets can be made "Kerbless" and **paved over in different Materials** to give the impression of being slow-speed and pedestrian dominated.
- **Paving along the main carriageway** helps create friction, making motorized vehicles move slower, thus increasing safety. Safe jaywalking is desirable on such streets.
- **Bollards and/or Tree Buffers** may be used to keep cars from entering the "Walk Only Zone" along the edges of the Street.





Chicane: Vancouver, Canada
(Crédit: Richard Drdul)

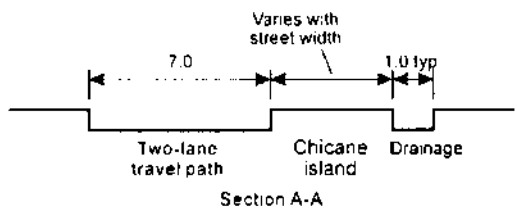
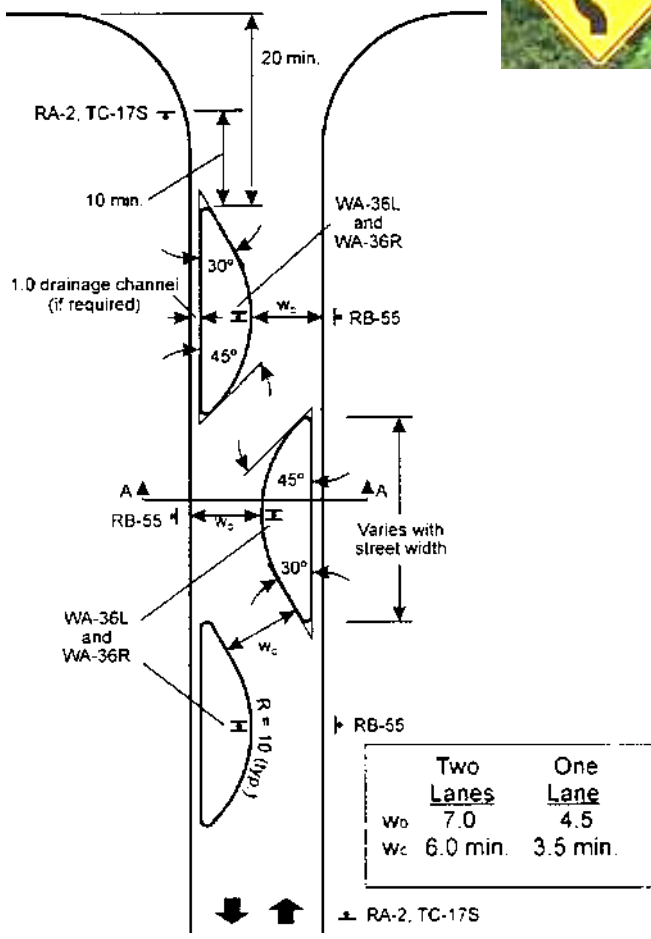
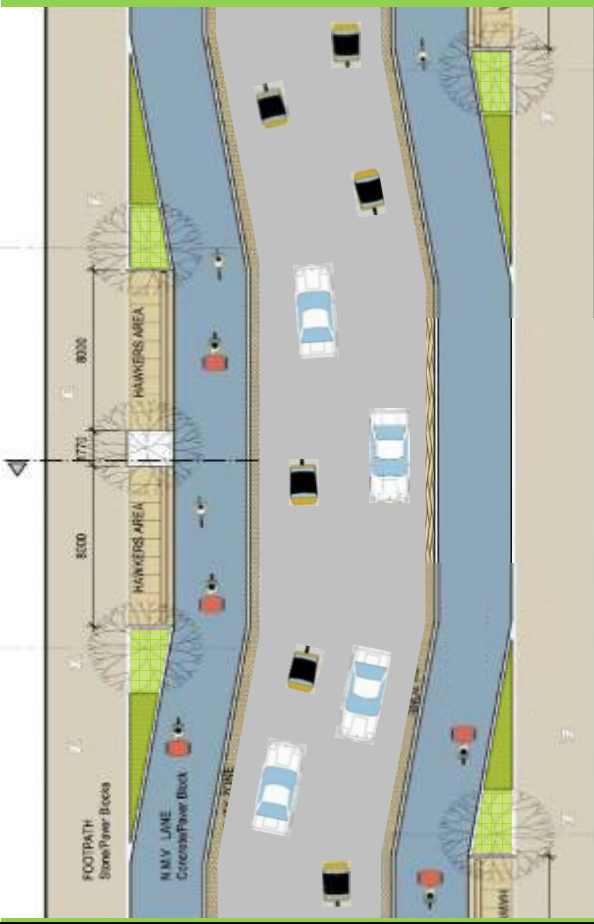

Sign Descriptions:

RA-2	Yield
RB-55	Stopping Prohibited
TC-17S	Yield to Oncoming Traffic
WA-36	Object Marker

- The travel path through the chicane can be one lane or two lanes as noted.
- Spacing of chicane segments dependent on site considerations, e.g. driveway locations
- Island plantings should not obscure driver's view of chicane traffic.
- Additional RB-55 signs may be required to satisfy local convention.
- Bicycles are to use the same path as motor vehicles, not the drainage channel.
- Depending on local climate and preference, vertical delineation other than Object Markers (WA-36) may be more appropriate. Possible alternatives include bollards, Delineation Markers (WA-37), landscaping and curb painting.

A chicane is a series of alternating mid-block kerb extensions or islands that narrow the roadway and require vehicles to follow a curving, Serpentine path – thus reducing vehicular speeds and increasing safety for pedestrians and NMVs.

Chicanes can be used on one-way or two-way streets and can be single lane or two-lane configurations.

Key Guidelines:

1. Chicanes can be created by modulating the "Multi Functional (Tree Planting) Zone in order to created the curved geometry. (See also: Section 04)
2. Chicanes must maintain the required clearances for emergency vehicle access.
3. Locate trees and planting (06C) within Chicane kerb extensions to capture and filter storm water, and add greenery to street.
4. Integration with Street Storm Water management plan is a must, as gutters may have to be incorporated in Chicane Design.

A Mini-Traffic Calming Circle is a raised island located in the center of an intersection around which traffic must circulate.

They are ideal for all Streets below the Hierarchy of Primary Collector (30-40 M or lower) where Design Speeds are to be kept below 30 km/hr for safety of all road users.

Key Guidelines:

1. Mini traffic circles should be large enough to force cars to slow down to go around them; but the outer two feet or so of the circles should have a concrete apron, with a low four-inch kerb such that emergency vehicles can go over easily when necessary. Typical Design speeds for movement around the circle should be 10 to 15 mph; exit speeds should be limited to 15 mph through the circle's design wherever possible.
2. Centres of mini traffic circles should be attractively landscaped. Planting of local, drought-tolerant and low-maintenance plants is encouraged. Local community participation should be sought in planting and maintaining of these circles.

Advantages:

- Reduces speeds and accident rates, particularly when applied consistently to an area.
- Can green and beautify the streetscape with trees and/or vegetation, improving environmental quality.
- Rain gardens and local planting in traffic circle can provide Stormwater treatment and reduce run-off, seasonal flooding and pressure on existing stormwater infrastructure.

Regulatory Signage

Local planting and Soil treatment for Storm Water Capture and Infiltration. See also:



Mountable Kerb with Permeable Paving

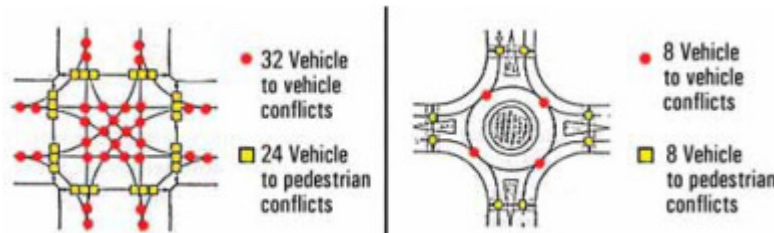

Conflict points at traffic calming circles (and roundabouts). Source: Stidger, Ruth "Can America Handle Roundabouts," Better Roads, 2003

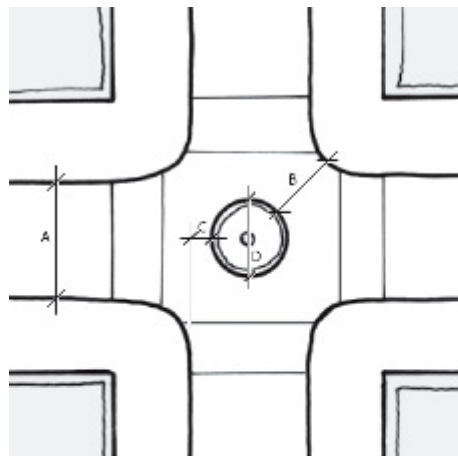

- A - Street Width: Existing
- B - Opening Width: Typically 16-20 feet
- C - Offset Distance: 5.5 feet max. (varies)
- D - Diameter: Typically 12-20 feet

Source: San Francisco Better Streets Plan

OPTIMAL DIMENSIONS	
Offset Distance	Opening Width
5.5' (max)	16' (min)
5.0'	17' (-/+)
4.5'	18' (-/+)
4.0'	19' (-/+)
3.5' or less	20' (-/+)

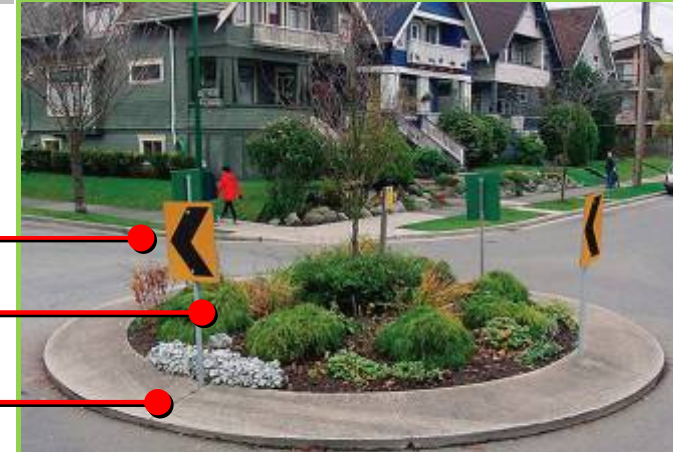

Mini Traffic Circle in Vancouver, Canada
(Crédit: Richard Drdul)

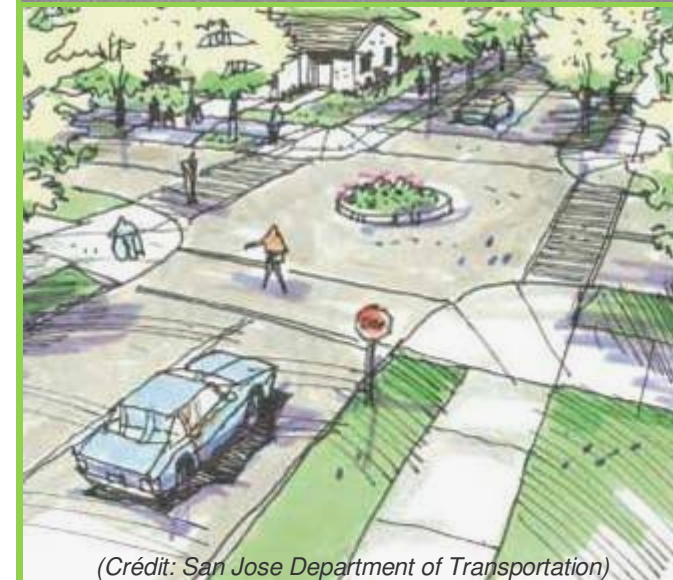

(Crédit: San Jose Department of Transportation)

Mini Traffic Calming circles should not be confused with **Full Roundabouts**, which handle much higher traffic volumes and encourage free flowing, faster movement of motor vehicles, thus making intersections less safe for pedestrians.

Full Roundabouts are NOT RECOMMENDED, unless necessary for handling 5 or 6-arm road intersections.



Full Closure in Residential colony: Vancouver, Canada
(Crédit: Richard Drdul)



Full Closure in a Mixed Use District: London

Full Closure is a physical barrier at an intersection to fully close a street segment to motor vehicle access at one end.

- The barrier can be a fence or bollards, a basic sidewalk, or an elaborate landscaped space or plaza.
- The affected street segment becomes a cul-de-sac for motor vehicles, while pedestrian and bicycle access can be maintained through the use of a dedicated bicycle channel or other design elements.
- Emergency vehicle access can be maintained by using mountable kerbs and a clear path.

Key Benefits:

1. Speeding through traffic is completely eliminated, limiting street access to only local residents/ users. **Permeability to pedestrians and NMVs is maintained, ensuring easy shortcuts for these users.**
2. Pedestrian and NMV safety is enhanced by eliminating vehicular crossing at the closure.
3. Larger closures can create a sizeable public spaces with community facilities such as seating, plantings, etc.

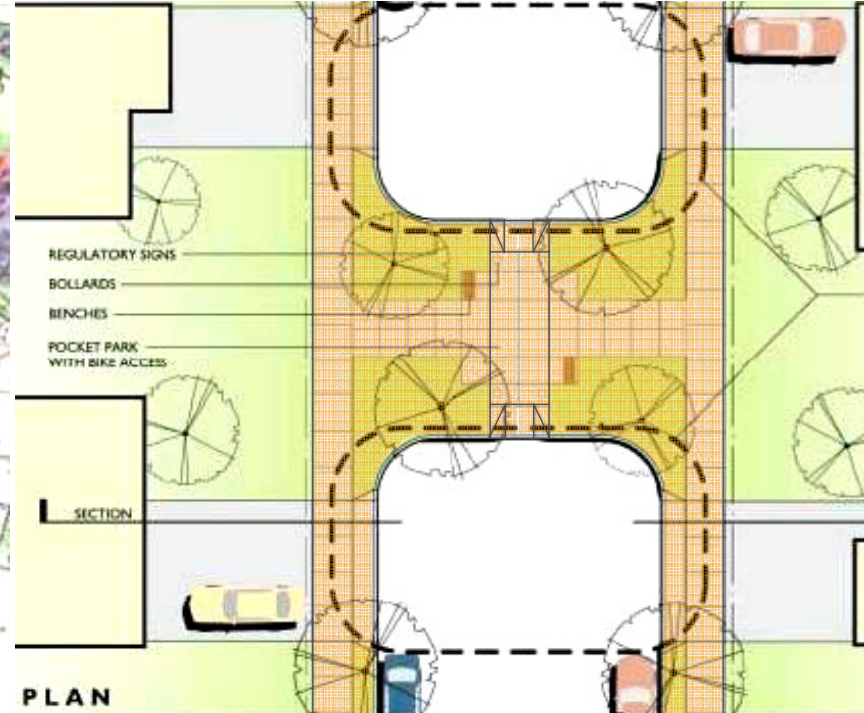

12 Material Selection

- 12A Material Selection Guidelines
- 12B Sustainable/“Green” Material Options
 - Concrete with Cement Substitutes
 - Clay Substituted: Fly-Ash Bricks
 - Recycled Asphalt
 - Recycled Rubber Pavement
- 12C High-Albedo Materials
- 12D Permeable Pavement
- 12E Paving Sub-grade
- 12F Edge Courses
- 12G Accent Materials

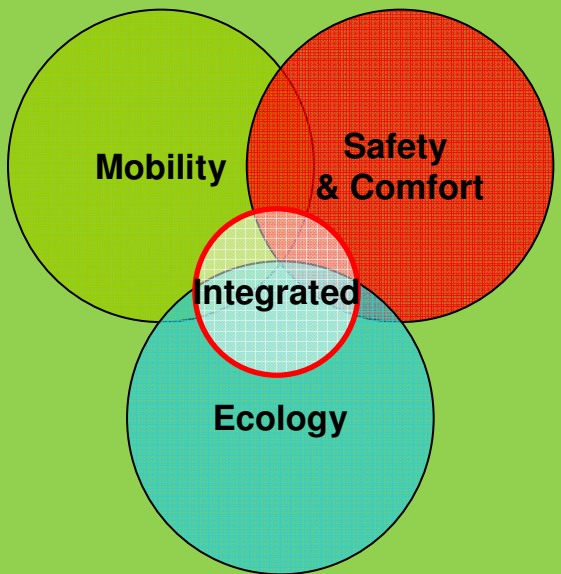
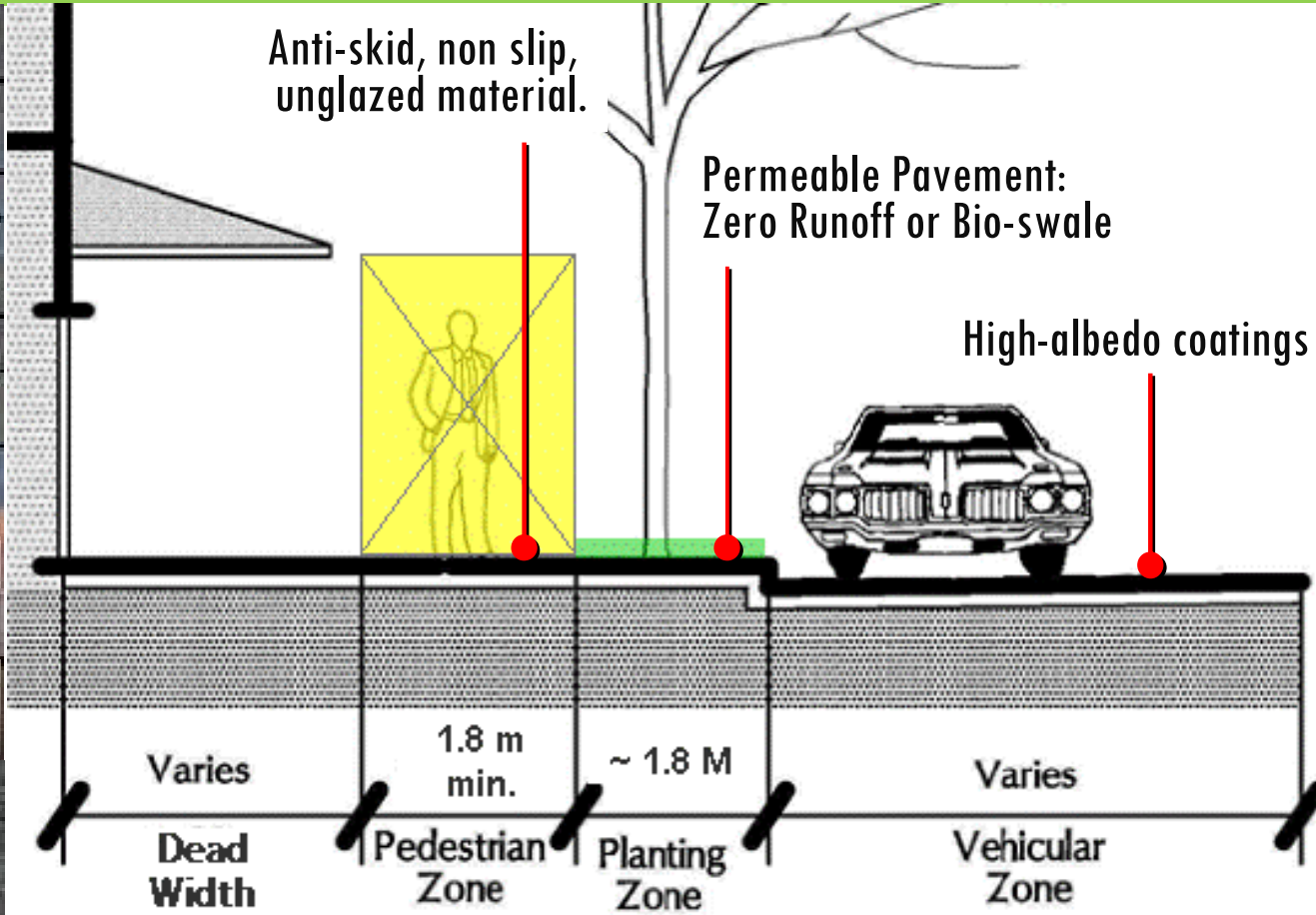
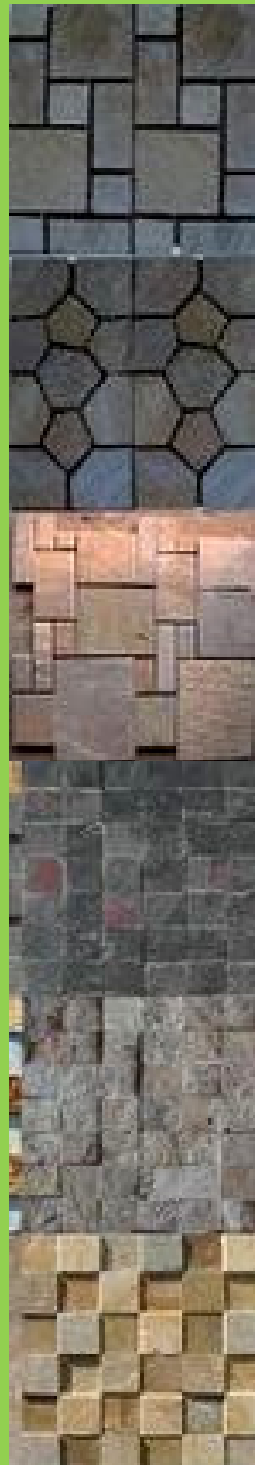

Appropriate Selection of Materials in design impacts the aesthetics, usability and comfort of the street for all its users – and in the long run has a huge impact towards endearing these places to the people of the city.

Materials selected should have minimal impact on the environment in terms of carbon emissions, embodied energy, life-cycle costs, quarrying, transporting and top-soil preservation. Materials selected should reduce storm water runoff and urban heat island effect, as much as possible.



12A Material Selection Guidelines

Recommended Materials for Exterior Use:*

	Areas	Do's	Don'ts
1	Footpath	Anti skid / matt finish tiles, interlocking paving tiles, sandblasted Stone, unpolished Stone, checkered tiles	Polished Stone finishes
2	Kerb ramps	Anti skid / matt finish tiles; Flared sides with tactile paving, exposed Cement Concrete	Polished Stone finishes
3	Tactile paving	Vitrified unglazed pavers in bright colour contrast to the flooring surface (preferably canary yellow)	Stainless steel or metal pavers in dull /slippery finish
4	Signage	Bright colour contrast big font signages on non-glare surface- acrylic, metal (fully painted) with retro reflective paints	Glass, stainless steel, aluminum
5	Bus Stops flooring	Anti skid / matt finish tiles with vitrified unglazed tactile pavers in bright colour contrast to the flooring surface	Glazed vitrified tiles, Granite, polished Kota stone
6	Streetlights	White color, mercury lights- full cutoff fixtures	Yellow lights
7	Handrails	Stainless steel 304/316, OD- 40-45mm, scotch-brite or matt finish	
8	Light signals	Audio signals with time display	Normal light signals
9	Table top	Any load bearing anti-skid pavers, tiles	Cobble stone
10	Table top slopes (on road side)	Cobble stone may be provided	Polished granite or any other Slippery Surface
11	Median refuges	Any load bearing anti-skid pavers, tiles	Cobble stone
12	Cycle tracks	Preferred Pavement Quality Cement Concrete	CC Paver Tiles and Polished Finishes

*Prepared in consultation with Samarthyam, TRIPP and SGA

12B Suggested Sustainable/“Green” Materials

All paving materials, as a rule – should be finished as anti-skid, non slip, unglazed material.

Key Guidelines:

1. Locally Available Materials should be preferred i.e. majority of the materials should be available within 250 km of site.
2. Since most road projects are redevelopment projects – Reuse/ recycling existing road construction materials is preferable and advisable.
3. Materials which have some recycled content or that can be recycled after use should be preferred. E.g.:
 - Recycled Asphalt
 - Recycle Rubber
 - Flyash
 - Recycled stone or other existing construction materials.
4. Long life, durability and ease of repair of materials must be factored in during material selection and project cost calculations.
5. Use and depletion of finite raw materials should be reduced - by replacing them with rapidly renewable materials. (Rapidly renewable materials are ones that are typically harvested within a 10 year cycle, eg, bamboo products, corn products, wheat based products, strawboards etc.).
6. Materials with low cement content and low embodied energy should be given preference.

Recommended Options:

Materials which have some recycled content or that can be recycled after use should be preferred. E.g:

- Recycled Asphalt
- Recycled Rubber
- Flyash
- Recycled stone or other existing construction materials.
- Recycle components in Concrete

Not Preferable

12B-i Recycled Asphalt

Why is traditional Asphalt environmentally unsustainable 



Excessive use of stone Aggregate component of Asphalt – leads to excessive mining/quarrying which implies:

- Use of water and fuel for mining (= CO₂ emissions)
- Quarries abruptly interrupt the continuity of open space, ruining habitats for flora and fauna alike.
- Stone quarrying causes air pollution, most notably dust.

Asphalt pavement is commonly composed of 5 percent asphalt (a petroleum derivative) and 95 percent Coarse (stone, gravel), and Fine (sand) aggregates - laid down in layers and compacted.

Asphalt Pavements are highly recommended if the following substitutes are incorporated:

1. Aggregate Substitutes for Asphalt Pavement:*



Nonferrous Slag



Low-carbon content Fly Ash



Scrap Rubber Tyres

- **Substitutes for Coarse Aggregate = Crushed concrete, foundry sands, hydrated coal fly ash and slag.** Air cooled blast furnace slag and steel slag in particular provide good rutting resistance and superior friction properties, making it a choice aggregate for the surface course.
- **Substitutes for Fine Aggregate = Addition of about 35 volume % Coal Fly Ash** to the aggregate component of hot-mix asphalt (HMA) enhances the resistance of the asphalt to cracks and potholes. **This new type of hot-mix asphalt should last at least five times longer than the normal hot-mix asphalt.**
- **Asphalt Binder Modifier = Ground Recycled Rubber**, if added to the HMA prior to mixing with the aggregates, allows it to chemically react with the mixture. Asphalt concrete pavements made with rubber modified asphalt cement tend to have less cracking, and wear better than regular pavements. They also significantly reduces traffic noise when used on carriageways.

- 2. **Asphalt pavement could potentially be 100% recyclable and be reused as a Subgrade [See 12D] for new streets.**
- 3. **High-Albedo Coatings** along with color pigments may be applied to Asphalt—to reduce Urban Heat Island Effect [See 12C]

Functional and Cost Benefits:

- The hydrophobic nature of fly ash gives pavements better resistance to cracking & potholes, making them safer and more durable, with a longer Pavement life.
- Cost saving by decreasing the need for asphalt binder.
- Less expense and frequency of required maintenance treatments to keep the pavement in good functioning condition.
- Reusing materials reduces the need for mining virgin aggregate and the associated environmental impacts. (See left)



www.pwri.go.jp/team/pavement/english/subject/projects.html

*Source and Copyright 2008: by The Industrial Resources Council
<http://www.industrialresourcescouncil.org/Applications/HotMixAsphaltPavement/tabid/378/Default.aspx>

12B-i Recycled Asphalt



a) Imprinted Asphalt:

Machine-heated asphalt, imprinted with a pattern template and colored with protective coating.

Application:

- Pedestrian Dominated Streets with restricted vehicular traffic [See 11D], Pedestrian only streets, Plazas

Benefits:

- Can be installed on existing asphalt that is in good condition.
- More cost-effective and easier to maintain than unit pavers.

b) Hexagonal Asphalt Pavers:

Asphalt pre-cast into hexagonally-shaped pavers.

Application:

- High wear and tear Sidewalks

Benefits:

- Hexagonal pavers are relatively easy to reset or replace, especially for utility access.
- Easy to replace and/or recycle.

c) Thermoplastic Imprinting:

Thermoplastics applied into grooves created by heating and imprinting the asphalt.

Application:

- Crosswalks/ Road Markings
- Public Art on Streets

Benefits:

- Because the thermoplastics are imprinted below the level of the road surface, the application will not begin to wear until about ¼ inch of the asphalt has been worn away, resulting in a longer lifespan than typical thermoplastic crosswalks markings.

Why is Concrete the most environmentally unsustainable 



a) Extremely high GHG Emissions:

Emissions:

The cement industry produces 5% of global man-made CO₂ emissions, of which 50% is from the chemical process of heating Calcium Carbonate, and 40% from the burning fuel.

b) High Embodied Energy:

The process of cement manufacture uses large amounts of Energy.

c) Mining of Virgin Aggregates:

The coarse and fine aggregate components of concrete lead to excessive mining and quarrying with its associate negative impacts like fuel and water consumption, habitat destruction and CO₂ emissions.

Cement – an integral component of Concrete – is the single biggest material source of carbon emissions in the world. The use of Concrete for roads and pavements is NOT recommended unless the following components of traditional concrete are substituted:

1. Cement Substitutes in Concrete = Class F Fly-Ash*

Owing to its pozzolanic properties, Class F Fly ash can be used to replace 30-70% by mass of Portland cement. This has been successfully implemented in various projects around India.

Benefits:

- The setting time of Flyash concrete is slower BUT the final concrete's strength, chemical resistance and durability is substantially higher.
- Due to the fineness and spherical shape of fly ash particles, the fluidity and workability of fresh concrete is much higher, thus reducing water demand during mixing.

2. Aggregate Substitutes = Recycled glass cullet; Crushed recycled concrete itself*

- **Concrete made with recycled concrete aggregate** has at least two-thirds the compressive strength and modulus of elasticity as natural aggregate concrete
- **Crushed and screened waste glass** may be used as a Fine Aggregate i.e. Sand substitute in concrete, e.g. "non-recyclable" clear window glass and fluorescent bulbs. Possible applications for such waste-glass concrete are bike paths, footpaths, gutters and similar non-structural work.

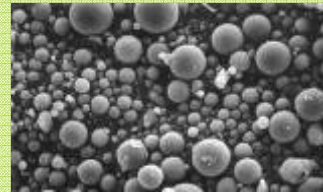

Coal Fly Ash



Recycled crushed concrete



Recycled Glass Cullet

Application:

Bike Paths, Footpaths, Gutters and any non-structural concrete works.



*Source: Toolbase Services
<http://www.toolbase.org/TechInventory/>

12B-iii Clay Substituted: Fly-Ash Bricks

Not Preferable

Bricks are one of the most long lasting and beautiful materials that can be used for pedestrian paved areas. However, they are recommended only if the following substitutes to Clay are incorporated:

Why are Clay Bricks environmentally unsustainable?



Fly-Ash Bricks (FAB) are the most desirable alternative to traditional Clay-fired Bricks:*



- a) Composition:**
FABs comprise of Class C Fly ash –a waste product of the coal-power industry, sand and other additives. Pulverized Class C Fly Ash is a self-cementing material which gradually hardens on contact with water.
If not used for bricks, fly-ask is a waste product that pollutes the environment further by landing up in landfills.
- b) Manufacture:**
Fly Ask bricks require no burning and are manufactured by a steam bath and compression process and then toughened with an air entrainment agent.
- c) Benefit:**
Beautiful material achieved at 20% less cost and a fraction of the Energy Consumption and Carbon Emissions of a traditional clay brick.

a) Top Soil Depletion:

The Clay used for Brick manufacture generally comprises of the fertile top-soil which is ideal for agriculture. Depletion of this fertile top soil is highly undesirable.

b) High Embodied Energy and GHG Emissions:

The process of burning bricks in a kiln during manufacture consumes large amounts of Energy and causes huge Green House Gas Emissions.

Application: Plazas, Seating and Accent Areas.

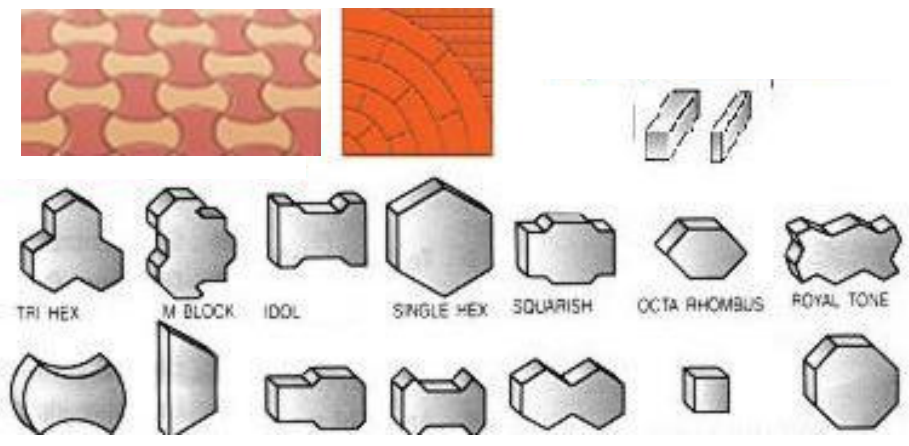

Flyash Bricks and Pavers are widely available with various Manufacturers in India.

Pictures Source: Alibaba.Com, Global Trade Portal

*Source: The Building Brick of Sustainability: Construction Specifications Institute Magazine
http://calstarproducts.com/wp-content/themes/default/pdf/BldgBrick_Sustainability.pdf



Recycled Rubber Sidewalks in Vancouver, CN



Easy to mould around trees, ramps, etc.



Extremely easy to apply and repair.

Benefits	Rubbersidewalks
Life Cycle Near Tree Roots	15+ years
Life Cycle In Freeze-thaw	15+ years
Installed Material Cost*	\$19.80/sf
Crew Needed	2 man crew
Completion time	500 sf/day
Recycled Content	100%
ADA Compliance	Low vibration
Size	2'x2.5' x 1.875"
Weight	10.8 lbs/ sq ft
Appearance Changes	Darkens over time
Mass Changes	Possible settling
Trip Hazard	Low to zero
Maintainability	100 percent (\$1.50/sf)
Walking Comfort	Highest
Porosity	Highest
Coefficient of Friction (non-skid)	.90 Dry/.65 wet
LEED Qualified	Highest
Environmental Impact	100% recycled rubber, reduced heat island, low water run-off, low energy need

Rubber Sidewalks – are an interlocking modular open-grid pedestrian paving systems – which are potentially the most sustainable alternative to concrete paving.

➤ **Composite Rubber Sidewalks are being developed by the Shriram Institute for Industrial Research. Samples and Test sites are yet to be seen.**

Advantages & Cost Benefits:

- Rubber sidewalks allow periodic tree root inspection, access to utilities, without costly concrete repair and replacement. Modular system allows pavers to be periodically opened for inspection and immediately 'reinstalled'
- Rubber sidewalks are unbreakable. They can also easily be cut to fit corners and different shapes on pavements.
- Unlike Rubber sidewalks, concrete cannot be "maintained" and must be demolished, off-hauled, and replaced when damaged.

Environmental Benefits:

- Directs water into soil (Permeable) thus reducing water run-off into storm drain.
- Resilient though firm, more comfortable and healthy to walk on.
- Absorbs sound, reduces decibel level of foot and wheeled traffic
- Safe, non-toxic and flame resistant
- Can be used in tree wells as well as sidewalks
- Excellent for use in temporary sidewalk situations, e.g. events or construction sites.
- One-square-foot of Rubbersidewalks recycles waste rubber from one passenger tyre
- Rubbersidewalks can be recollected and recycled at the end of their life cycle and the material used again.

Application: All sidewalks.

Not Preferable



Dark colors of some materials such as asphalt, tremendously increases the urban heat.

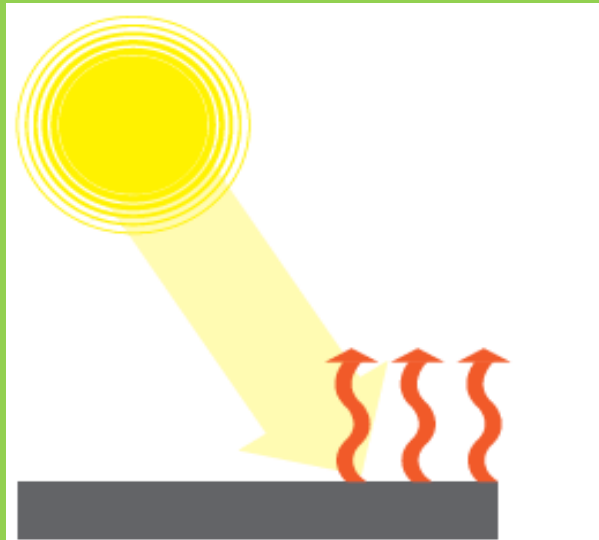

Darker paving absorbs more sun-rays and radiates it back as infra-red, increasing ambient air temperature.

12C/01F High Albedo Materials

High Albedo/ 'Reflectivity' Materials reflect more of the sun's rays and absorb less heat than traditional black asphalt pavement or darker paving materials, thus mitigating the urban heat island effect.

- Most cool pavements use materials such as lighter colored aggregate, sand, and cement products.
- **High Albedo Materials can reduce pavement surface temperatures by 11 °C-22 °C**, and this may increase pavement life.

Key Design Guidelines/ Application:

01F

- Choose light-colored pavers (Light gray, beige and tan colors), aggregates or top coats, preferably with a reflectivity of 0.29 or higher.
- Parking lots, pavements, roads, driveways and other surfaces can have **coatings or integral colorants** added to increase reflectivity.
- If paving with asphalt, applying a **white aggregate as a chip seal layer**, or a light-colored surface coating such as a zinc-oxide slurry mix.

Table 6.2 Comparative Unit Costs of Selected Pavement Treatments*

Treatment	Unit	Unit Cost, \$/SY/in or \$/SY	Estimated Service Life, Years
Hot-mix asphalt	SY/in	\$1.00-\$1.50	7-20
Plain-jointed portland cement concrete	SY/in	\$3.00-\$5.00	15-35
Reinforced concrete	SY/in	\$7.00-\$13.00	15-35
Whitetopping	SY/in	\$3.00-\$5.00	10-15
Ultra-thin whitetopping (refer to text)	SY/in	\$40.00-\$60.00	Relatively new technique
Slurry seals	SY	\$0.90	2-8
Microsurfacing	SY	\$1.25	5-10
Chip seals	SY	\$0.85	2-8
Thin hot-mix overlay	SY	\$1.75	2-12

*Heat Island Reduction Initiative, U.S. Environmental Protection Agency

Best Practices



Light-colored paving; Carter Road Promenade, Mumbai



Highway showing left side paved with high-albedo asphalt and the right side paved with conventional asphalt.

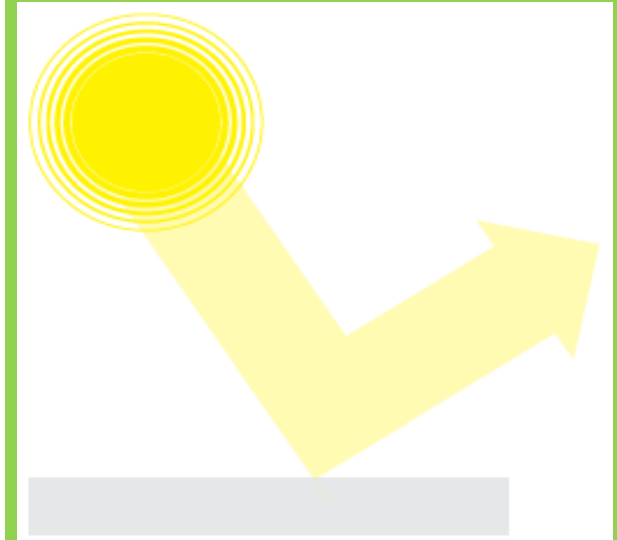

By reflecting more sunlight, lighter-colored paving reduces the urban heat island effect

Not Preferable



After 2 hours of rain....



After 4 hours of rain...

The increase of impervious surfaces in Delhi has led to serious flood issues.

12D/01G Permeable Pavement

Permeable pavement is a paving system which allows the rainfall to percolate into an underlying soil or aggregate storage reservoir, where stormwater is stored and infiltrated to underlying subgrade, or removed by an overflow drainage system.

Permeable pavements provide ground water recharge and reduce pollutants in stormwater runoff into rivers and Nallahs.

Application:

- Permeable paving is most suitable for large paved areas without heavy foot traffic or any fast vehicle movement. Therefore, all areas within the **Multi-Functional Zone** [Section 04], **parking lots, driveway kerb-cuts, large plazas, hawker zones, pedestrian only streets, etc.** are most suitable for permeable pavements.
- **The sub-grade of porous paving surfaces must be porous to a minimum depth of 150 MM well** – in order to achieve the desired level of permeability.

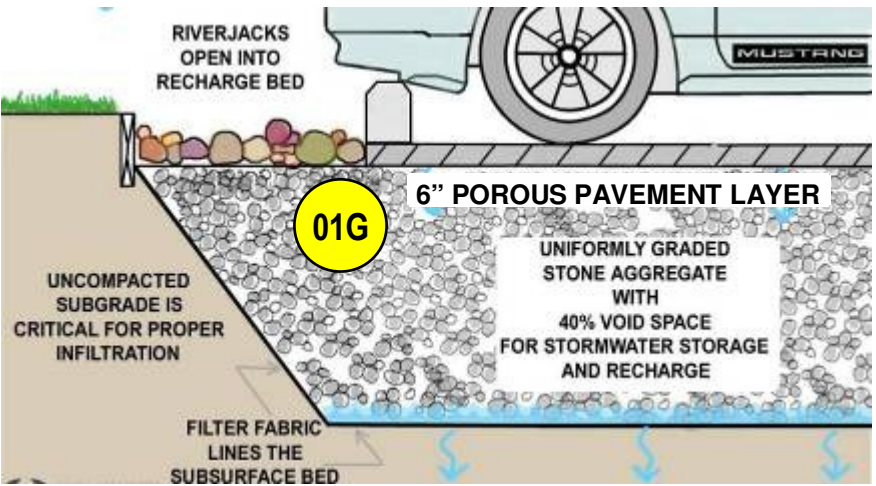

Best Practices



Parking Lot in Sydney, Australia



Hawker Zone in Shanghai, China



Permeable Rubber Sidewalk in Vancouver



A

Permeable Asphalt

Fundamentally the same as regular asphalt, but it does not contain the fine particles that asphalt does, hence, creating porosity.

- **Need to be cleaned 2 to 4 times a year to avoid build-up of debris.** But some research has found that even with 99% clogging the infiltration rate can be up to 10 inches/hr.
- It **does not require special training** and can easily be supplied by conventional asphalt batch plants



B

Permeable Concrete

This is a variation of traditional concrete, but without the fine particles in the mix.

- Installation is quite different from the traditional method, and **requires experienced installers** both in the mixing and laying of the product.
- Proper maintenance includes periodic vacuuming of the surface to **prevent clogging with sediment or organic material.** With proper maintenance it can last a minimum of 20 years.

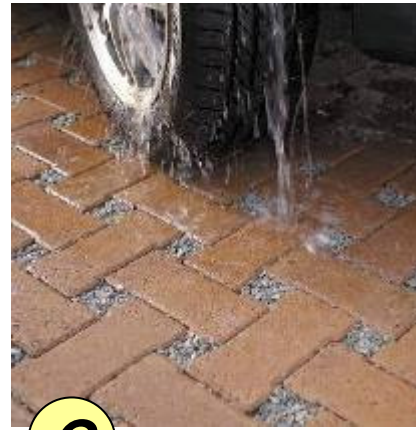

C

Interlocking Concrete Pavers

Themselves are not always permeable, but they are typically installed with gaps between them to allow infiltration into the subsurface. The gaps, typically 10% of the surface area, are filled with a permeable material, usually small clean stone.

- **They have a long useable life, are relatively easy to install** and provide good infiltration.
- However, they are **sensitive to deformation** in the base and do require a thick base to prevent "heaving."



D

Open-Celled Paving Grid with Vegetation

Open-celled paving grids consist of a rigid grid composed of concrete or a durable plastic that is filled with a mix of sand, gravel, and topsoil for planting vegetation.

- The plastic grid pavers are also **flexible, allowing them to be used on uneven sites.**
- They do not require another drainage facility and are **competitively priced to asphalt and concrete paving,** when their required drainage costs are factored in.



E

Open-Celled Paving Grid with Gravel

The same open-celled grid structure is employed but the voids in the rings are filled with a mix of gravel.

- With the gravel in place this grid system does **provide additional structural support.** And since most grid-cell material is plastic, hence flexible, it can adapt well to shrink/swell and freeze/thaw conditions.
- Most commercially available geocell material is made from recycled material, an added environmental plus.

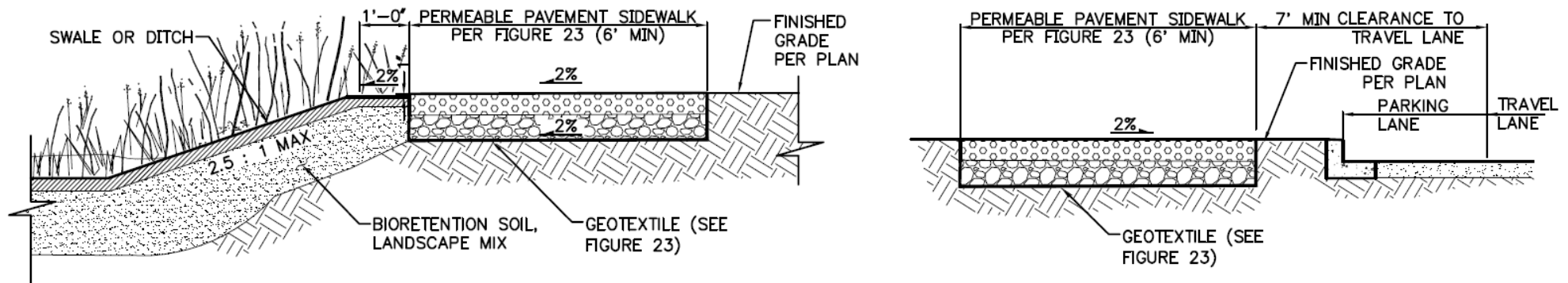

Application and Design Considerations:

In general, sites where pervious pavement will be installed needs to meet the following criteria:

- Soils need to have a permeability of at least 0.5 inches per hour. An acceptable alternative design for soils with low porosity would be the installation of a discharge pipe from a storage area or "Percolation Pit".
- Areas that have high potential for contamination such as transfer stations, gas stations, or highly industrial areas may not be suitable for permeable pavements due to the increased risk of groundwater contamination.
- The bottom of the stone reservoir should be flat, so that runoff can infiltrate through the entire surface.
- The seasonal high water table should be at least 1M below grade.
- It should be installed at least 30 M away from drinking water wells.
- Pervious pavements should not be used in areas with a slope > 15%, as erosion of the fill material may occur.

Maintenance for All Permeable Pavements is critical to their performance:

Permeable pavements and pavers require some additional maintenance to keep them functioning properly:

- Inspect for surface material that may clog the pavement: Inspect the project upon completion to remove any fine material that has accumulated on the surface. Conduct periodic visual inspections to determine if surfaces are clogged with vegetation or fine soils. Clogged surfaces should be corrected immediately.
- Periodic vacuum sweeping or pressure washing: Permeable concrete and permeable asphalt surfaces should be swept with a high-efficiency or vacuum sweeper at least once every month. High pressure hosing could substitute for sweeping or supplement sweeping if material appears clogged. For gravel pave or unit pavers, replace gravel if clogging occurs.
- Replenish aggregate: Replenish paver aggregate material as needed.

12E Sub-Grades and Sub-Bases

[12 B] Paving as per design - over mortar or appropriate binding material

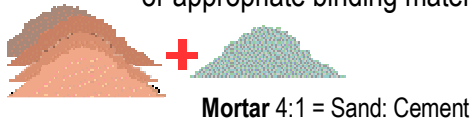

Mortar 4:1 = Sand: Cement

Paving + Mortar
Bedding

Bedding layer carries the final surface layer. This is usually a coarse grit sand, with a low clay content and with good drainage properties.

Sub-Base layer is often the main load-bearing layer of a pavement.

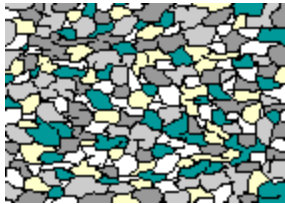

Unbound Materials rely on natural interlock.

They are Permeable;

May comprise:

- Generally a mixture of coarse (gravel) and fine (sand) aggregate.
- Could also comprise of crushed stone, crushed slag, crushed concrete or non-plastic well-burnt shale.

Application: Universal



Bound materials use a binder like cement or bitumen (tar).

They are Impermeable.

May comprise:

- 100-150 MM thick cement concrete slab
- Recycle granular materials like blast-furnace slag, mixed with cement and water and compacted.

Application: Only pavements where heavy loads or bad grounds are expected.

Pavement After Construction | Virgin Soil Before Construction

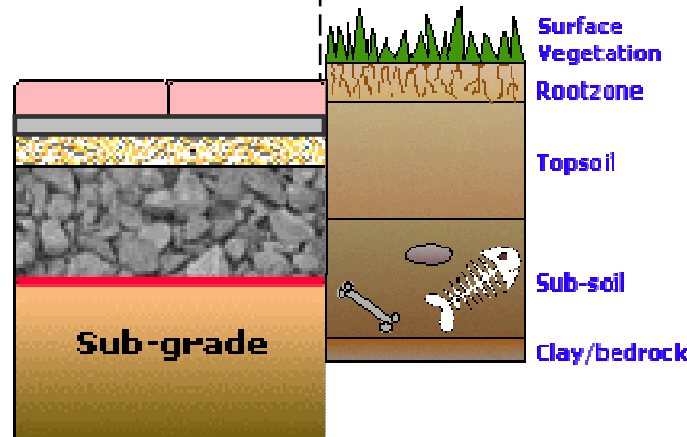

Sub-Grade is the lowest point of the pavement structure - the underground level at which excavation ceases and construction starts. Sub-grade mostly comprises of compacted earth, except for Permeable Pavements where it must be kept uncompacted.

Geo-textile Fabrics – like GeoJute, etc. These are often non-woven, permeable sheets applied between pavement layers to prevent the various layers of the pavement mixing or disappearing into lower layers. They thus prevent premature cracking of the surface pavement layers, especially Asphalt.

Functions: Separation between base layers where required; Filtration (liquids and gases); Reinforcement of pavement layers.

Applications:

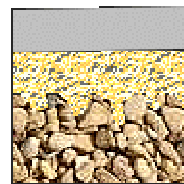

Bedding can settle into voids in sub-base

Between Bedding & Sub-Grade

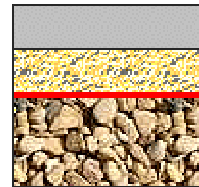

Geo-fabric stops bedding settling into sub-base

Between Sub-base & Sub-Grade

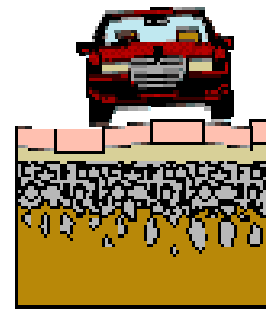

In case of clayey soil, geo-textiles help keep the overlying sub-base material from sinking into a clayey or softish sub-grade.

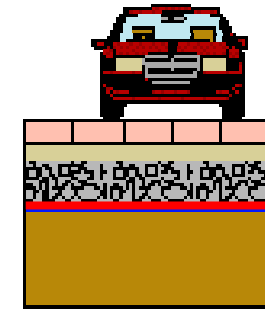

Root Barrier Geo-textiles protect drainage and foundations

Around utilities & foundations

12F Edge Courses

Edge Courses – Functions and Applications:

Edge courses provide a number of functions in a properly constructed block pavement. These functions can be divided into three categories:

Structural:

They form the restraining edges for a pavement.

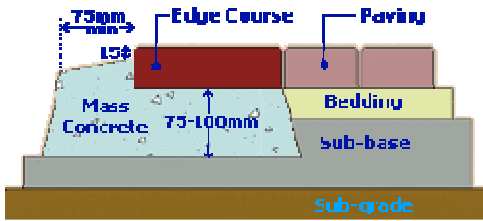

Edge Course functionally important at a Free Edges (e.g. parks, soft edges, etc)

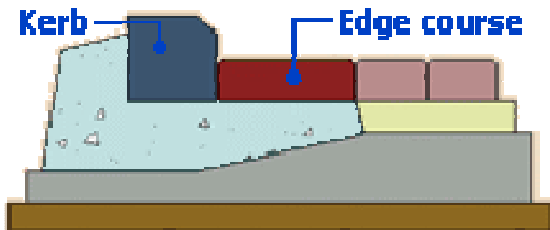

Where a kerb is present, the edge course may be purely functional/aesthetic.

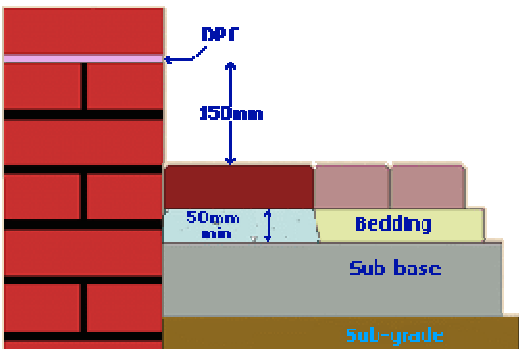

Edge Courses at building edges can help direct water away from building foundations.

Functional:

They eliminate the need for cut blocks at the edge of a pavement.

They can be used as level guides for preparation of the screeded bed.

They facilitate cutting-in procedures.

They can act as drainage channels, directing surface water to a suitable disposal point.

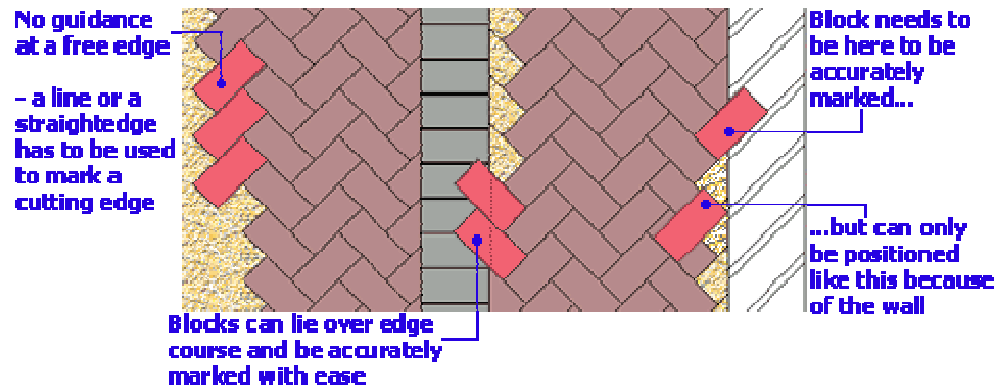

Aesthetic:

They form a frame to the pavement that gives it definition and shape.



Brick Drainage Channel in Walkway

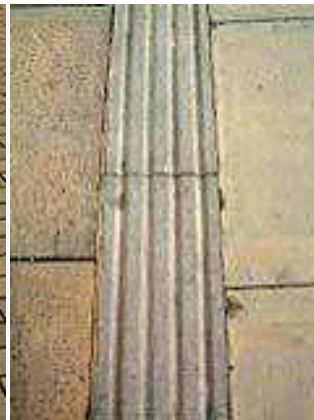

Fluted Drainage Channel in Walkway



Concrete Drainage Channel in Asphalt Pavement

Public Art engraved Stone Tiles with brick tile paving.

Paving in Rough Kotah stone. Seats in stone masonry. Kiosk columns clad in ceramic mosaic. (Vikas Sadan, Delhi)

Red tinted PCC Tiles and concrete bollards with glaze Ceramic tile highlights. (BRT Delhi)



Different colors and textures of Brick and Red Sandstone use to create this warm and well scaled Plaza.

Permeable grass pavers use in sloped seating area with walkway in rough finished stone pavers. (Shanghai)

Ceramic Tiles use on vertical surfaces and risers of steps to add color (Bikaji Cama Place, Delhi)

This page is intentionally left blank.

13 Public Art, Street Furniture, Educational Signage



Paving Patterns



Public Awareness Campaigns



Manhole cover art, Chandigarh

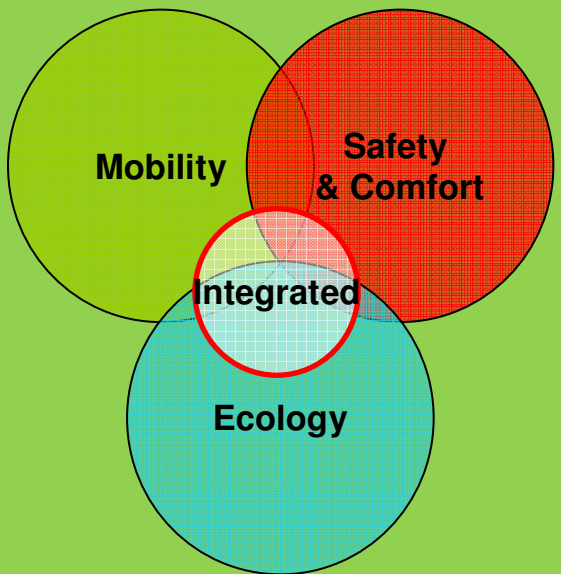

Public Art in Delhi must be integrated with regular street furniture, Signage or Education and Awareness Messages, etc. in order to play a dual role – “utility” as well as “aesthetics”. It can be a powerful tool for education and outreach. Carefully designed art could have a significant impact on the behavioral patterns of people.

Public Art also helps build civic pride and a sense of ownership amongst citizens, especially if local communities can be involved in their installation, renewal and maintenance.

Street Furniture is an important component of streets as it helps create resting or “pause” spaces along the daily paths of people and makes streets more enjoyable. All Street Furniture should be located within the Multi Functional Zone and kept CLEAR of the designated Walking and NMT zones of the street.

ELEMENTS OF THE URBAN INFRASTRUCTURE POSSIBLY USABLE AS PUBLIC ART (Suggestive Only):

- Pavements
- Boundary Walls
- Tree Trunks
- Manhole Covers
- Fences and Handrails
- Street Furniture
- Dustbins
- Public Toilets
- Bus Stops
- Pavements

Not Preferable



When there is no feeling of belonging, pavements are not maintained and littering is common



A Common Site in Delhi due to the abundance of unwatched boundary walls.

13A Boundary Wall Art!

The long-term solution to walls and footpaths being used for public urination and spitting - is the removal of boundary walls and creating “eyes on the street” – which would also make the city safe for women. See page 21.

In the short-term – the abundant boundary walls around the city could be used for educative public art.



A Boundary Wall in Kalbadevi, Mumbai used for ‘Environmental Education’ Art – created by children through NGO cooperation.

Best Practices



Educative Public Art on boundary walls is used as a “Signature Statement” throughout the Streets of Philadelphia, US

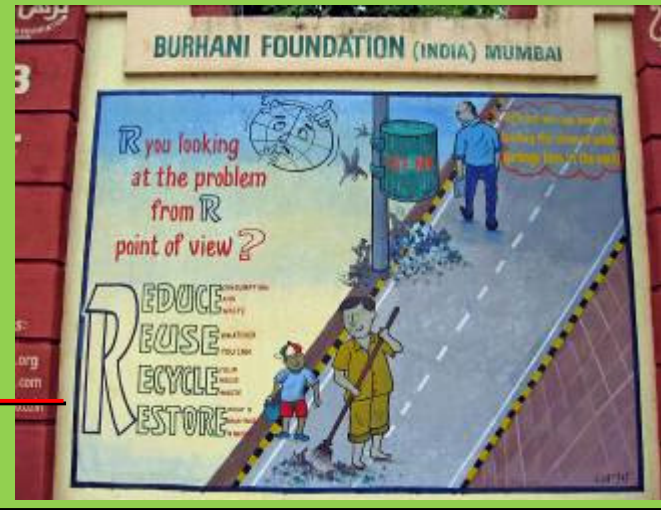

13B Art on Dustbins, Bollards

Innovative, clean, well maintained and well loved Dustbins are the key to a “Clean” City.

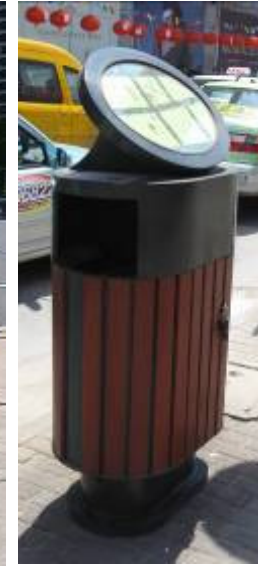

- An Artistic way (graphics, cartoons) could convey – why and what kind of waste should go into which bin – even to illiterate users.
- In Philadelphia, Art on Dustbins strongly convey the Environmental Philosophy of the City.
- Maps on dustbins showing location of nearest landmarks and public toilets.

“How to use” Delhi’s new ‘source separated’ dustbins is a mystery to most people in the city.

Bollards play a huge role in segregating areas for “pedestrian use only” and help increase safety and usability of public spaces and footpaths.



- Bollards could be designed as expressions of **public art** (through city level design competitions or design festivals).
- This would help generate civic pride and a sense of ownership amongst Delhi citizens.



▪Full Cutoff Bollard Lights enhance visibility without Glare.



Art for Conveying..... Important SOCIAL MESSAGES:

Bus stops can be used as canvases of public art conveying messages about **anti-eve teasing, anti-molestation of women, anti sexual abuse etc....**



Example of Social abuse Signage at a Bus Stop in New York.

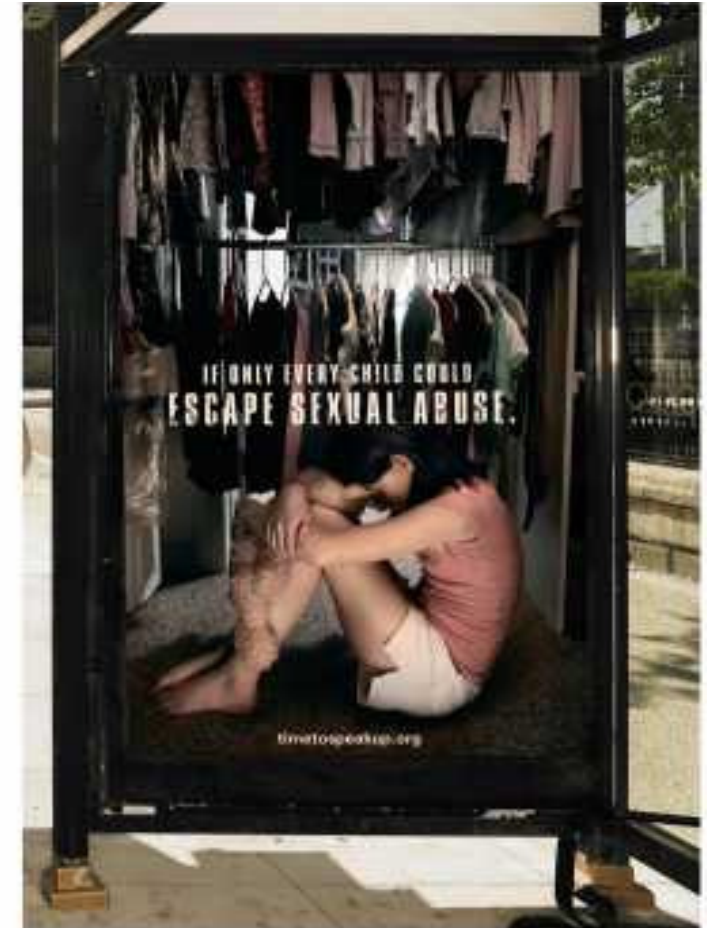

Safety Data of Delhi shows that most women find buses and bus-stops the MOST UNSAFE places in Delhi.

“The most unsafe time out - 40% felt unsafe between 8 and 10 am and 5 and 7 pm. 31% felt unsafe in mid-afternoon.

Most unsafe places - 45% identified buses as the most unsafe; 25% the roadside; 6.7% found bus stops...”

– A Delhi Police survey on women’s safety, 05 March 2006.

Source: <http://southasia.oneworld.net/article/view/127142/1/>

13C Maps at Bus and BRT Stops, Metro Stations.

- Adequate Wayfinding Signage and well-designed, artistic and bi-lingual “Local Area Maps” should be displayed at all Metro Station Exits and at Bus Stops – showing local roads and important civic destinations.
 - Bus Stops and Metro Stations should also display an Overall System Route Map.
- Information about bus routes and timing must also be displayed in static signage (even if intelligent signage exists).

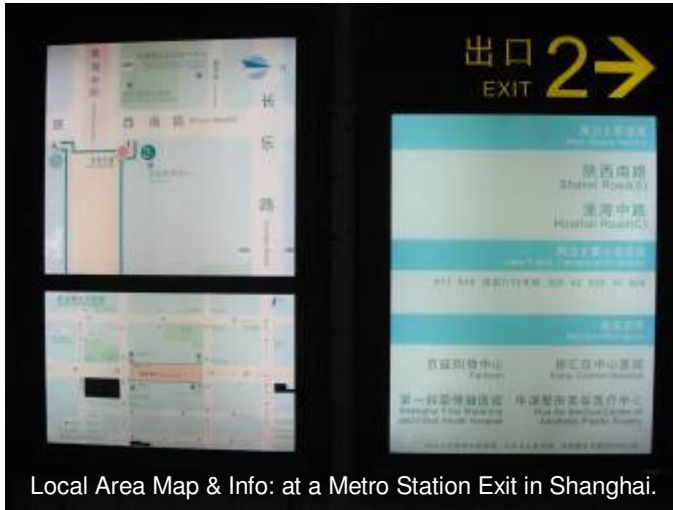

Local area map at a bus stop, Shanghai



Advertising and Signage at a bus stop, Delhi

Seating is an essential piece of Street Furniture which provides pedestrians and especially public transport users an opportunity to rest or pause, in the mist of their daily schedules...

- Seating provided must be easy to clean, located in areas that are well watched, busy, and well shaded by trees or artificial canopies - to protect people from the harsh Delhi heat.
- Ideally low maintenance seating should be located under deciduous trees and designed for easy cleaning and maintenance.

Functional Public Art: SHADED SEATING...

*Chair extensions hold up the roof over your head, while providing a seating place at the same time.
(Street furniture: Hudson Riverfront, New York)*



Well shaded, easy-to-maintain Seating, Beijing

Lack of Adequate Seating Facilities in the City, especially near Transit Stations

13E Art & Awareness: Trees, Planting, Public Involvement.



The Delhi Tree Plantation Drive could be more streamlined towards planting new trees along streets and in specific urban areas where afforestation has taken place or areas where green areas are scarce.

School children should be involved in not **only planting but also monitoring the growth** of saplings so that they develop a sense of ownership to their work and in turn the city.

An online or tele-volunteering program could be launched, once areas for planting are identified and designated.

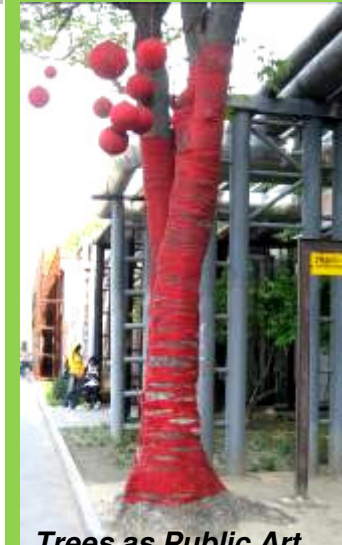

Trees as Public Art...



adding color!



Green Streets, Portland

As per Guideline 04C, when Natural Storm Water Management Systems are implemented in the city - **Generating public awareness about these "living streets" will be very important for the maintenance and success of these projects.**



Wetland Centre, Hong Kong

Wetland Centres could be set up near the neglected and dilapidated natural lakes and wetlands of Delhi (e.g. Sanjay Lake, Mayapuri Wetland, etc.) to make people aware of natural storm water systems in the city and the importance of maintaining the Nallahs, street-swales, etc.



Mayapuri Wetland (above) and Sanjay Lake.



Photos: Hindustan Times

13 Public Art, Street Furniture, Educative Signage



Public Art: Cycle Parking at Powell Books, Portland

Pedestrian & cycle subways under Railway Tracks, etc should be well lit and incorporate local public art - to give a sense of ownership with the community.

Recycled bicycle parts - for seating



Street banners would give a sense of place and identity to unique neighborhoods and destinations of the city.

They are easy to install – banner supports can be clamped on the existing streetlamps or other street poles.

14 BRT Systems, Bus and HOV Lanes

- 14.1 'Closed' BRT System
- 14.2 'Open' BRT System
- 14A Common features of both BRT Systems
- 14.3 HOV/carpool/bus lanes
- 14.4 Bus-Only Corridors
- 14.5 Guided Busways

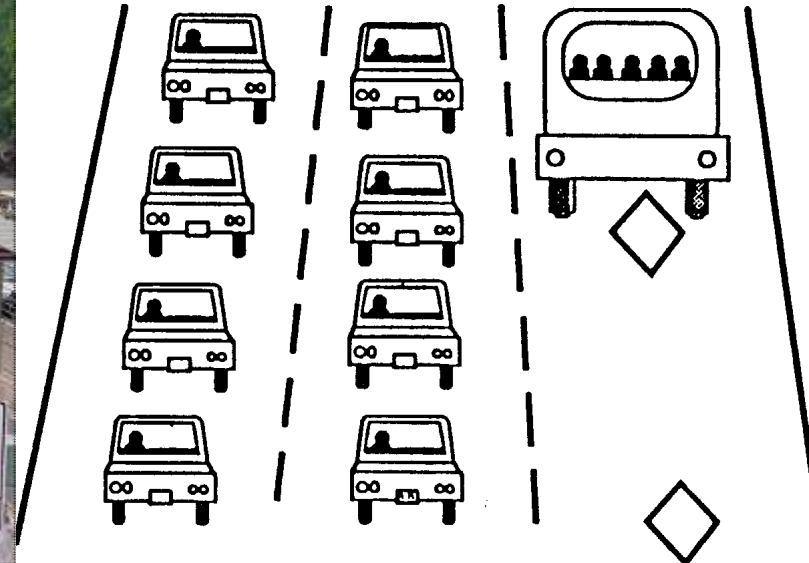

Bus corridors are an initiative to give dedicated road space and traffic signal priority to buses in order to reduce journey times and improve service consistency. The aim is to encourage people to shift to public transportation thus helping 'escape' traffic congestion.

The NUTP 2006 has recommendations for realizing these policy objectives:

- By reserving lanes and corridors exclusively for public transport and non-motorized modes of travel.
- Similarly lanes could be reserved for vehicles that carry more than four persons (known as High Occupancy Vehicle Lanes).
- India as a developing nation must promote wheel-based Public Transportation because of affordability issues with Delhi leading the way.
- Need for a guidelines to ensure flexible, efficient implementation of all typologies.

Masterplan of Delhi 2021 specifies:

On all roads with ROW greater than 30 m exclusive bus lanes will be planned to implement the Bus Rapid Transit System (BRTS) in a phased manner to cover the whole city.

Why Bus Corridors?

- Increases the efficiency and capacity of an existing road manifold, **by moving more people, not vehicles.**
- Substantially cheaper than Metro and other Rail-based systems
- Can run on narrow corridors and integrate with street life at-grade, as no grade separation is required, therefore does not create physical barriers for neighborhoods, cyclists, pedestrians or cars.
- Can and must integrate seamlessly with pedestrian and non-motorized transport networks.
- Flexible – can provide last-mile connectivity and alternate between a high-speed and local bus systems, as per System Design.

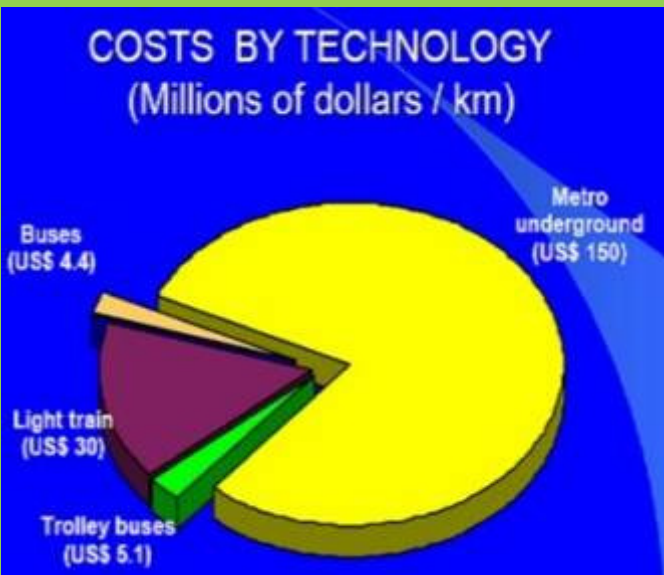

14 Types of Bus Corridors

TYPES OF BUS CORRIDORS:

1. 'Closed' Bus Rapid Transit System: is one that uses fully segregated and *operations controlled* corridors to provide a high capacity, high-speed, reliable and efficient Rapid Transit System, at much lower cost than rail based systems, and without the need for grade separation.

2. 'Open' Bus Rapid Transit System: is a flexible system which is a combination of 'fully segregated' as well as 'mixed-traffic' movement corridors for buses. It uses fully segregated, dedicated lanes to 'take out' buses from congestion and provide speed, efficiency and reliability to the overall Bus-System of the city.

3. HOV/ Carpool & Bus lanes: "High Occupancy Vehicle" lanes or 'bus-lanes' or car-pool lanes are lane prioritized for movement of vehicles carrying 4-people or more, especially during peak hours.

4. Bus-only Corridors: These are transit corridors on which only buses are allowed to ply, either during peak hours or for the entire day.

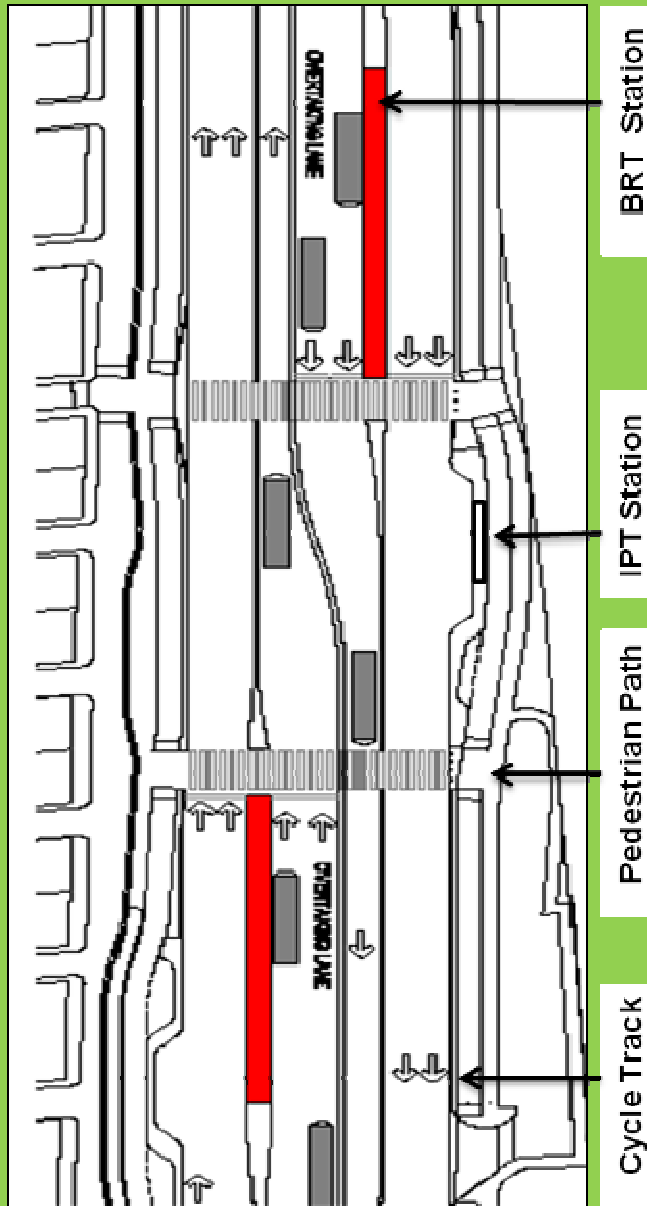

Mid block BRTS Station integration with IPT



MAXIMUM capacity of a Mixed Lane =
 $(2.2 \times 1200) = 2640$ Passengers/ Lane/ hour



MINIMUM capacity of a Dedicated Bus Lane
 = 9000 - 20,000 Passengers/ Lane/ hour

14.1 'Closed' Bus Rapid Transit System (BRTS)

A 'Closed' BRTS System is broadly defined as a Mass RAPID Transport System that is effectively "Rail on rubber wheels".

A 'Closed' BRTS system is one that uses fully segregated and *operations controlled* corridors to provide a high capacity, high-speed, reliable and efficient Rapid Transit System, at much lower cost than rail based systems, and without the need for grade separation.

A Closed BRTS System must have the following special features:

- 1) Origin-Destination (OD) based route selection.
- 2) Full Operations Control and full physical segregation of complete route.
- 3) Signal prioritization at all junctions and centralized control to ensure time-bound service.
- 4) Well designed Interchange points with Metro and integration of feeder services including local buses and para-transport modes.

A Closed BRTS System can be combined with an Open BRT System within the same busway – to be then called a 'Hybrid System'.

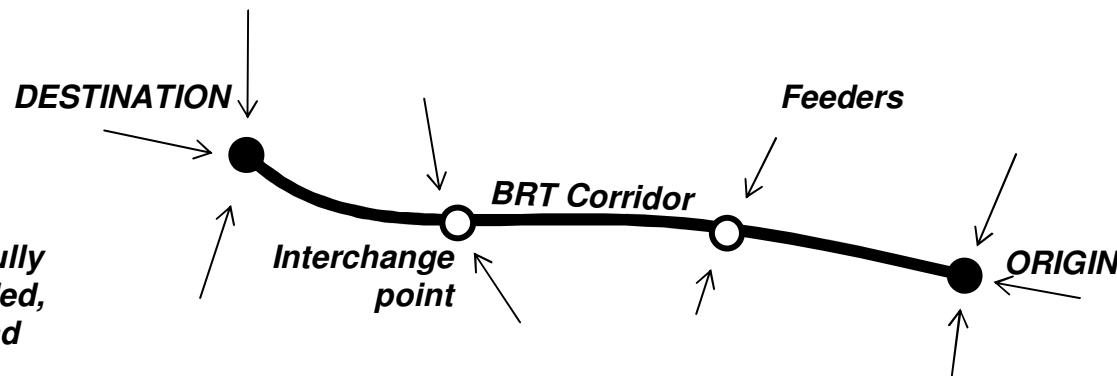

BRTS Corridor is fully operations controlled, fully segregated and based on Origin-Destination (OD) criteria.



Ahmedabad

BRT S terminates at Destination points.

14.2 'Open' Bus Rapid Transit System (BRTS)



Bus on Segregated BRT Corridor above



Same Bus as a feeder within neighbourhoods at end of journey

An 'Open' BRT System is a flexible system which **is a combination of 'fully segregated' as well as 'mixed-traffic' movement corridors for buses.** The System allows local bus-routes of the city to move in and out of the corridor as per requirements. Along all arterial roads and other required roads, the Open BRT System uses **fully segregated, dedicated lanes to 'take out' buses from congestion and provide speed, efficiency and reliability to the overall Bus-System of the city.**

(See page 150)

Note: MPD-2021 mandates: "On all roads with ROW greater than 30 m, exclusive bus lanes will be planned to implement the Bus Rapid Transit System (BRTS) in a phased manner to cover the whole city."

In the Delhi context, an Open BRT System would have the following features:

- 1) **FULL PHYSICAL SEGREGATION** of bus-lanes along major corridors to facilitate smooth, interference free and congestion free movement of buses along major stretches. (See page 150)
- 2) Signal prioritization and separate signal-cycles may or may not be required for Bus corridors – this to be decided as per need and design of specific junctions along the corridor.
- 3) Interchange points to be provided with the BRTS and Metro Systems at required locations.
- 4) The Biggest advantage of the "Open BRT System" is that – once the bus leaves the fully-segregated section, the same bus can become a "feeder service" into neighbourhoods at the end of the journey – thus providing "last mile connectivity" without change of Mode.
- 5) **Bus Corridors have all the features of a BRT Systems with the exception of full operations control requirements and need for signal prioritization at all junctions. They are also not necessarily OD-based Systems and are more intended to relieve buses out of congestion.**

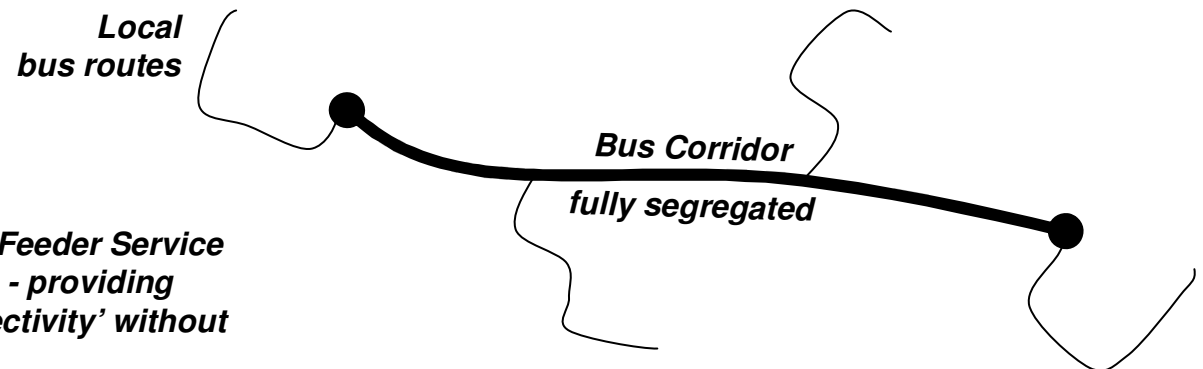

Same Bus as a Feeder Service in mixed traffic - providing 'last mile connectivity' without Mode change.

- 1 Complete Physical Segregation of Busways along major corridors.
- 2 Prioritization through Design and Management.
- 3 Integration with several modes of transport including *buses, feeder vans, Auto/Taxi, bicycles, cars/two wheelers, pedestrian crossings, cycle rickshaws, and future MRTS*, to ensure quick and easy modal interchange, efficiency and integrated ticketing system.
- 4 Location of doors – Mostly left side doors. However both side doors may be provided as per specific site conditions requiring the use of island stations.
- 5 Fleet Selection – Buses must be low-floor as they ensure accessibility to all sections of users including old people, children and people on wheelchairs, both within and outside the corridor.
- 6 Location of the interchange points close to road junctions.
- 7 Coordinated Construction, Regulation of Bus Operations, Management and Maintenance of the corridors and rolling stock operations as per requirements.
- 8 Utilization of the land resources, advertisement rights, congestion charges etc. for financial viability of the Busway System/BRT.
- 9 Assurance in removal of encroachment on the RoW and potential change of land-use for the properties affected by the development.
10. Public Outreach campaign to ensure Imageability.



The first Bus Rapid Transit system implemented in the world at Curitiba, Brazil.



Bogota BRT with segregated median lanes along with express lanes



Dedicated Bus ramp

1 Full Physical Segregation of Busways can be achieved through:

In the Delhi context, **FULL SEGREGATION** of a bus-corridor or busway is possible mostly with *central segregated lanes* only. In rare conditions, fully segregated *kerb-side* lanes are possible with very special design consideration to ensure physical segregation:

- a) Kerb side lanes on either side of the road cannot be *physically segregated* because access from driveways and side-streets must be allowed on to the main road from the edges. This constant interference slows down buses and does not allow for their seamless movement.
- b) In case kerb-side single bus lanes are physically segregated, overtaking during emergency situations would not be possible, in case a bus breaks down, etc.
- c) Bus only corridors are a good option for R/Ws that are critical for BRT Connectivity but may be too narrow to accommodate all modes. New corridors constructed can be in the form of Bus-only streets, tunnels, bridges etc. so that addition of more cars to existing roads and consequent congestion can be avoided.

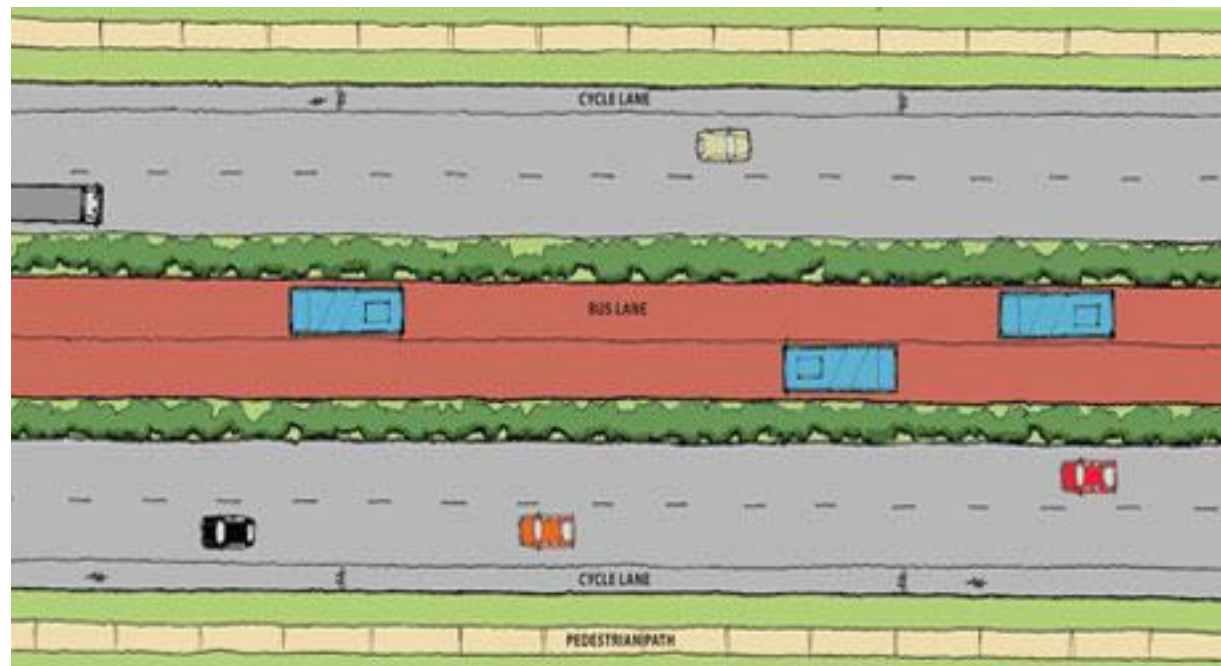

14A Common Components of BRT Systems:

2 Prioritization through Design and Management.

Prioritization is essential for 'taking buses out' of congestion and to make people prefer the use of buses over private vehicles.

Prioritization can be achieved through:

- Use of Intelligent Transportation Systems (ITS) technologies for corridors fully at grade.
- Dedicated bus-only corridors for interference free high-speed movement of people.

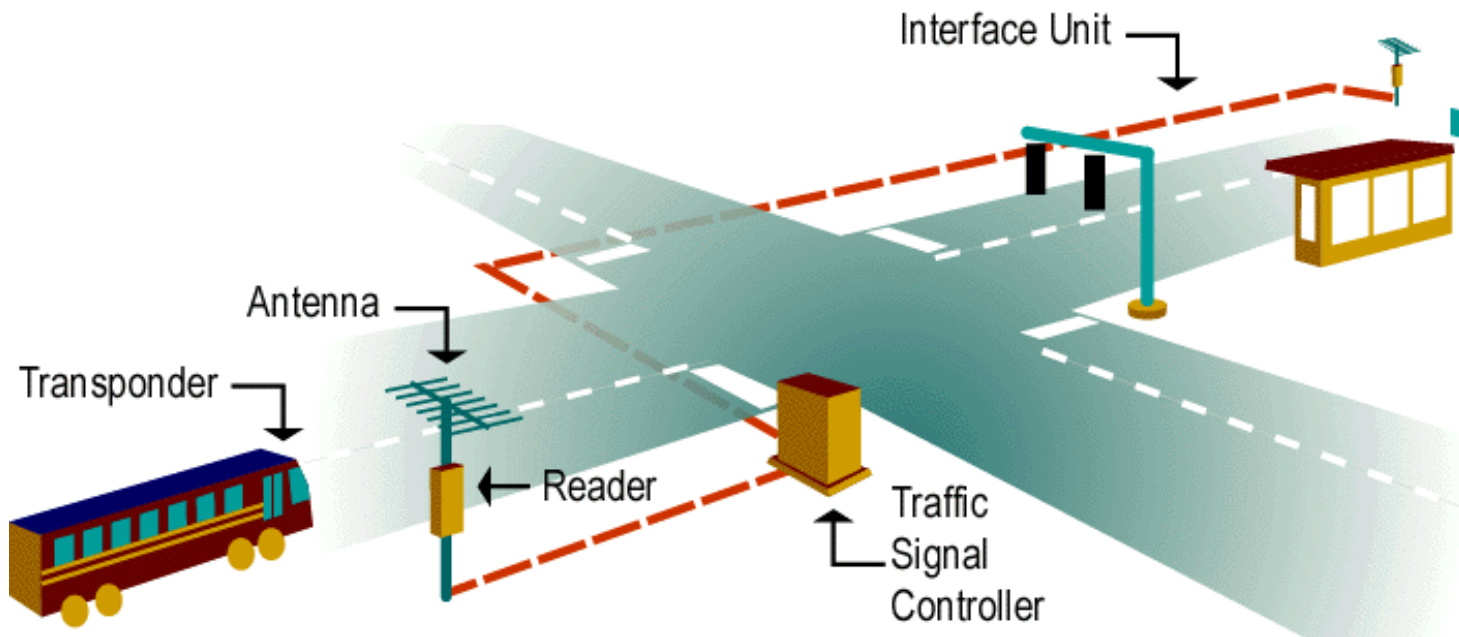

Treatment of existing flyover at Ahmedabad.

14A Common Components of BRT Systems:



BRT corridor in Delhi, with dedicated bicycle tracks alongside



3 Integration with several modes of transport including *other buses, feeder vans, Auto/Taxi, bicycles, cars/two wheelers, pedestrian crossings, cycle rickshaws, and future MRTS*, to ensure quick and easy modal interchange, efficiency and integrated ticketing system.



Multimodal interchange and Hawker Zones with pedestrian plaza at BRTS corridor Delhi

- 4** Buses with both-side doors may be required in corridors with median island bus-stops.
- 5** Fleet Selection – Buses must be low-floor as they ensure accessible to all sections of users including old people, children and people on wheelchairs, both within and outside the corridor.

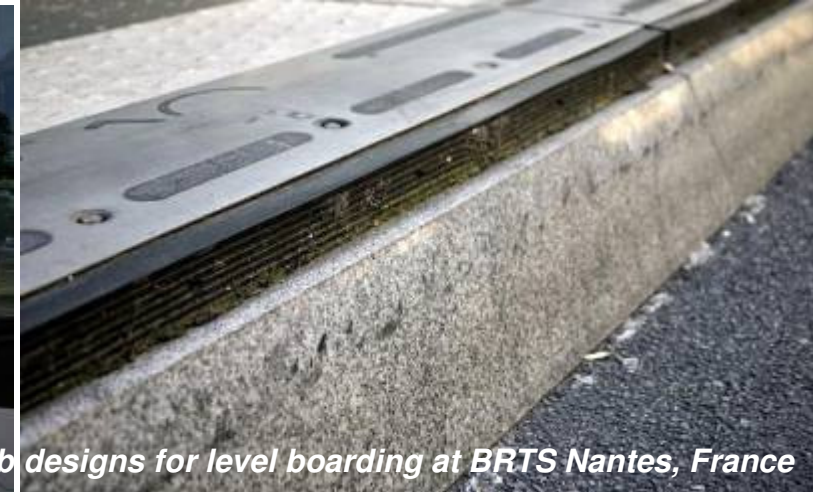

Special kerb designs for level boarding at BRTS Nantes, France

14A Common Components of BRT Systems:

6 Location of the interchange points in relation to the road junctions:

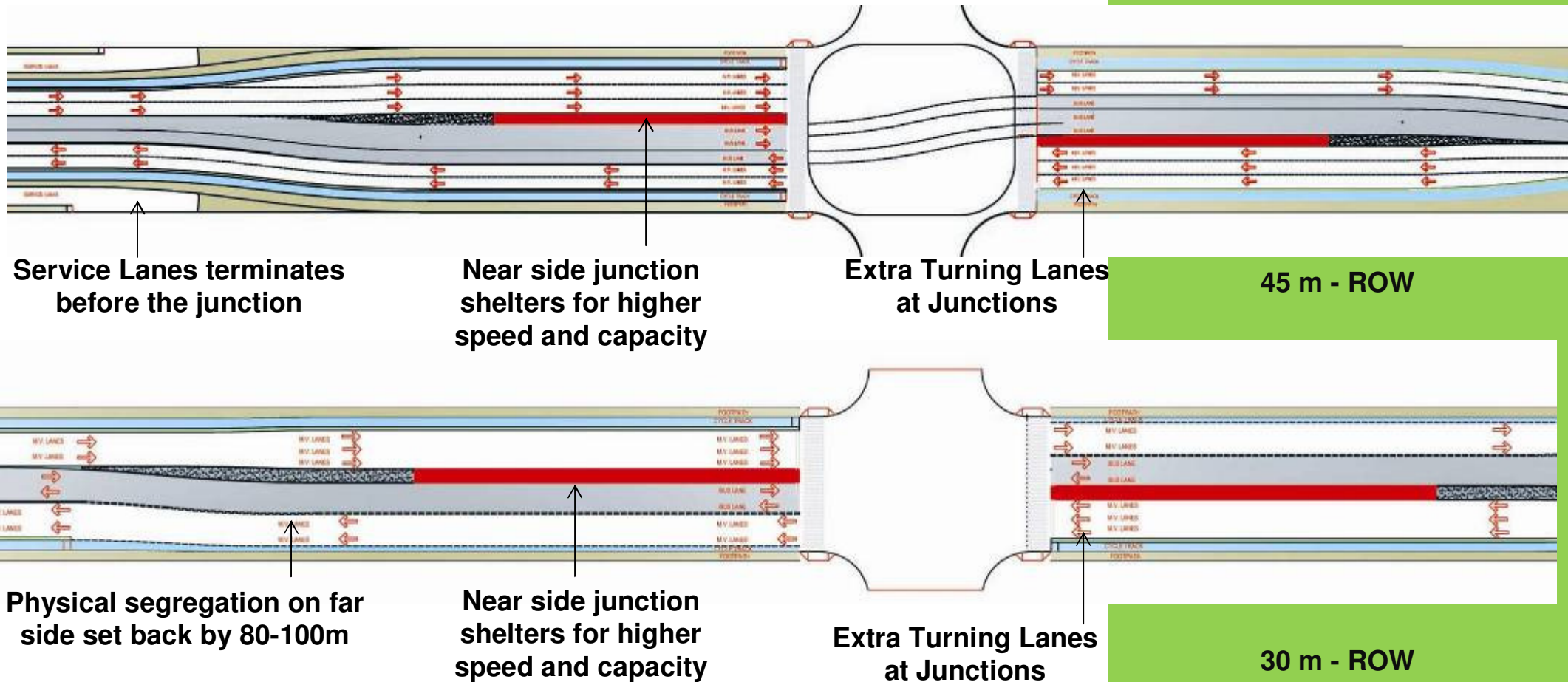

The issue of BRT Stops location and directional interchange at junctions has not yet been resolved by the Working Group.

The same will be resolved by the Group Members in the forthcoming weeks through various case studies of junctions in Delhi where BRT-BRT Arterial road intersections as well as BRT at existing grade-separated conditions are expected to arise soon.

Example Shown above:

- Junction design options showing how bus stops may be accommodated at junctions without any reduction in shared motor-vehicle lanes.
- Extra Left-Turning lanes can be provided at junctions, to reduce waiting time.

Advertisement rights ON Buses/ bus-stops could be a simple and great source of non-farebox revenue and fund source for BRT.

14A Common Components of BRT Systems:

- 7 Unified agencies should be responsible for Construction, Operations Regulation, Management and Maintenance of the corridors and rolling stock operations.
- 8 Utilization of the land resources, advertisement rights, congestion charges, corridor usage charges, revenue sharing on citations, etc. for financial viability of the road based public transport system/BRT.
- 9 Assurance in removal of encroachment on the RoW and potential increase in density of land-uses for the properties affected by the development.

The Transportation - Landuse Pyramid (Curitiba BRT):

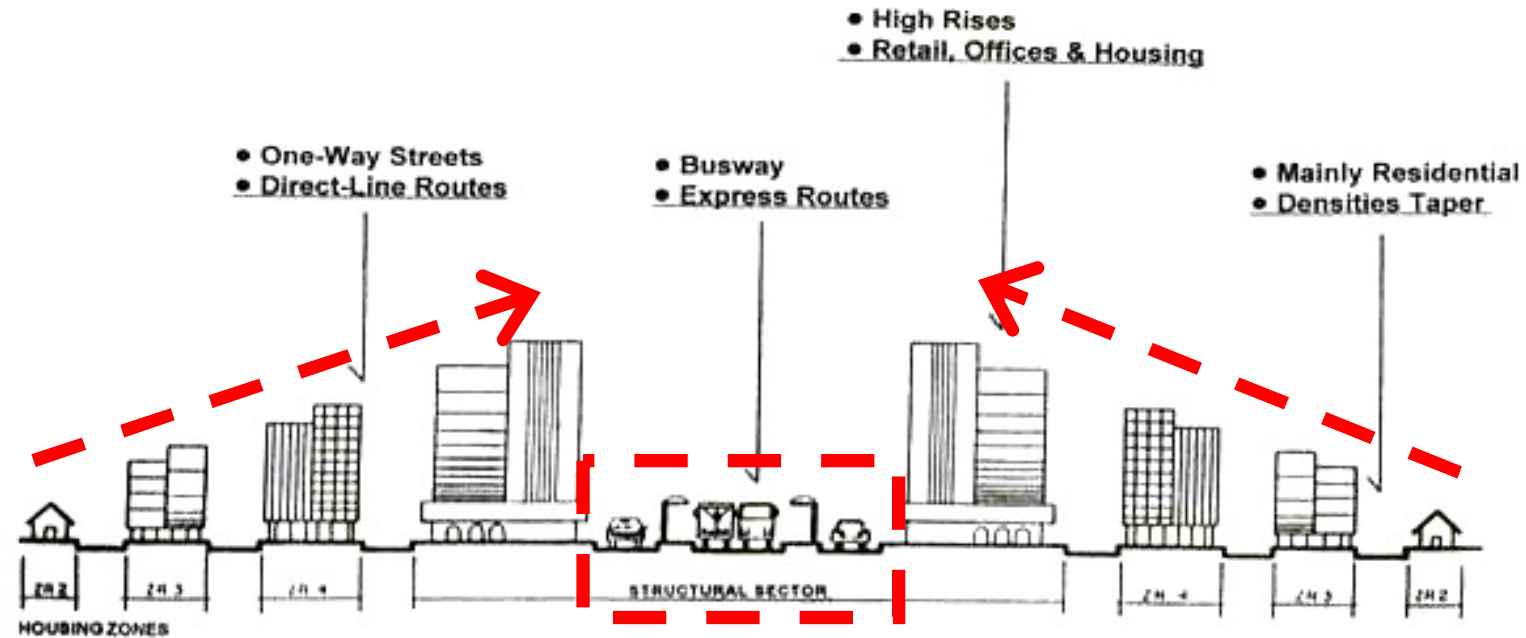

FIGURE 10.2. LAND USES AND DENSITIES ALONG TRINARY ROADS. A cross-sectional perspective. *Source:* Adapted from Instituto de Pesquisa e Planejamento Urbano de Curitiba (IPPUC).



Densification along major BRTS interchanges or terminal stations has many advantages:

- Maximum people can live-work near BRTS Stations and therefore can easily walk/cycle to BRT.
- Increased ridership
- Revenue generated can be a good source of non-farebox revenue to fund the BRT.



14A Common Components of BRT Systems:

- 10 Easy recognition, Imageability and Civic Acceptance:** The image of a BRT discerns it from the local bus system in terms of:
- **Special bus-stops** • **Signage** • **Signalling** • **Additional Single fare-box ticketing** • **Public Outreach/ Awareness Campaign** about its advantages - for acceptance by all sections of society.

For one and all

The bus stations, constructed along the median of the BRTS corridor, have special features that make the service convenient and safe for all sections of society, including the **visually impaired** and **physically challenged** as well as children and senior citizens.

Janmarg JANMARG

Level entry
The stations have raised platforms, which allow commuters to glide into the buses, which, in turn, have semi-low floors for this purpose.

Info display
LED screens at every BRTS station display the bus routes and route maps for the convenience of commuters.

Ramps for easy entry
Ramps have been installed at the entry and exit points of all **BRTS stations**, allowing easy access to the physically challenged. There are also special entry doors and tactile tiles to guide the visually impaired to the automated doors.



Screenshot of Janmarg BRTS promotional video

A Janmarg BRTS Poster



A distinct, legible and cognizable name and an extensive public outreach campaign helped the success and acceptance of the BRT in Ahmedabad.



Imageable Ahmedabad Bus station



Distinct BRT stations at Curitiba, Brazil

14.3 HOV Lanes/Carpool Lanes



Non separated Carpool lane with the diamond symbol signifying the reservation



Zipper lane (movable concrete barriers) on a Hawaiian interstate freeway.

High-occupancy vehicle (HOV) are reserved lanes used to convey vehicles with four or more occupants.

- HOV lanes can be deployed either only during peak hours or at all times - based on need.
- These lanes also allow certain emergency vehicles like ambulances, police cars etc.

Types of HOV lanes:

- a)Physically separated - Using concrete barriers, beams, cables, rubber pylons.
 - Concurrent - with the flow of traffic.
 - Contra-flow - against the flow of traffic as extra lane during peak hours with movable barriers.



Three beams as barrier

- a)Buffer separated - Buffer is a painted neutral area between HOV lane and normal lanes.
- b)Non separated - without any physical separation except a coloured line.



Buffer separated HOV lanes in Greater Toronto, Canada



Contra flow HOV lane in M27 Motorway at Hampshire, England

14.4 Bus Only Corridors

Best Practices

Bus-only corridors: are corridors which only allow buses and emergency vehicles (with NMV and pedestrian provisions) to ply on them either during certain hours or the entire day.

Need for Bus-only corridors:

- Where high capacity people movement is required and corresponding infrastructure costs are high.
- Core city areas where space is a constraint.

Types of Bus-only corridors:

- public
- a) **Bus-only streets:** Bus streets are entire streets reserved primarily for transport vehicles along with pedestrians and NMT.
- IPT and all par transport including autorickshaws, cycles and cycle-rickshaws may be allowed in addition to buses.
 - Provision for off-hour deliveries can be given.
 - All provide emergency vehicle access.
- b) **Bus-only bridges:** are bridges reserved for public transport.



Nicolett Street transit mall, Minneapolis with extra wide sidewalks created by removing through lanes.



Bus only road at Westboro , Ottawa, Canada



Bus only street at third avenue, Seattle, USA with provision for pedestrians

14.5 Guided Busways



Kerb guided busway at Cambridge UK



View of Guiderrail



View of kerb Guide wheel

Guided busways: are running ways on which buses are steered for part or their entire route by external means, usually on a dedicated track.

Need for Guided busways:

- Reduction in required running way (approx. 2.6m from 3.1-3.5)
- Accessible bus stops with no gap between bus & platform.
- Use of track for storm water management.

Types of Guided Busways:

- Kerb Guided Busways:** These are a form of mechanically guided busway system where a track wheel is used to guide the bus by running along the kerb.
- Optical Guided Busways:** These are a form of optically guided busway system where an optical tracking device is used to guide the bus along the route.

Applications: This system can be used for

- Streets with limited ROW
- Ecomobility corridors
- Railway Easement running ways for guided buses.
- Bus-only corridors
- BRT corridors

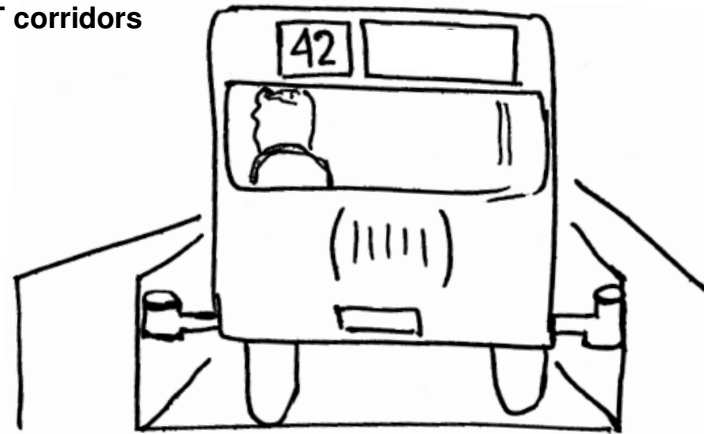

*Cartoon showing Guided Bus Section
Source: camcycle.org.uk*



Montage of Guided busways in Essen, Germany



Optical guiding device on bus in Rouen,



Guided busway along NMV track in Germany

Case Study: ITO : I P Marg. 45m R/W.

(www.uttipeec.nic.in)

Existing State

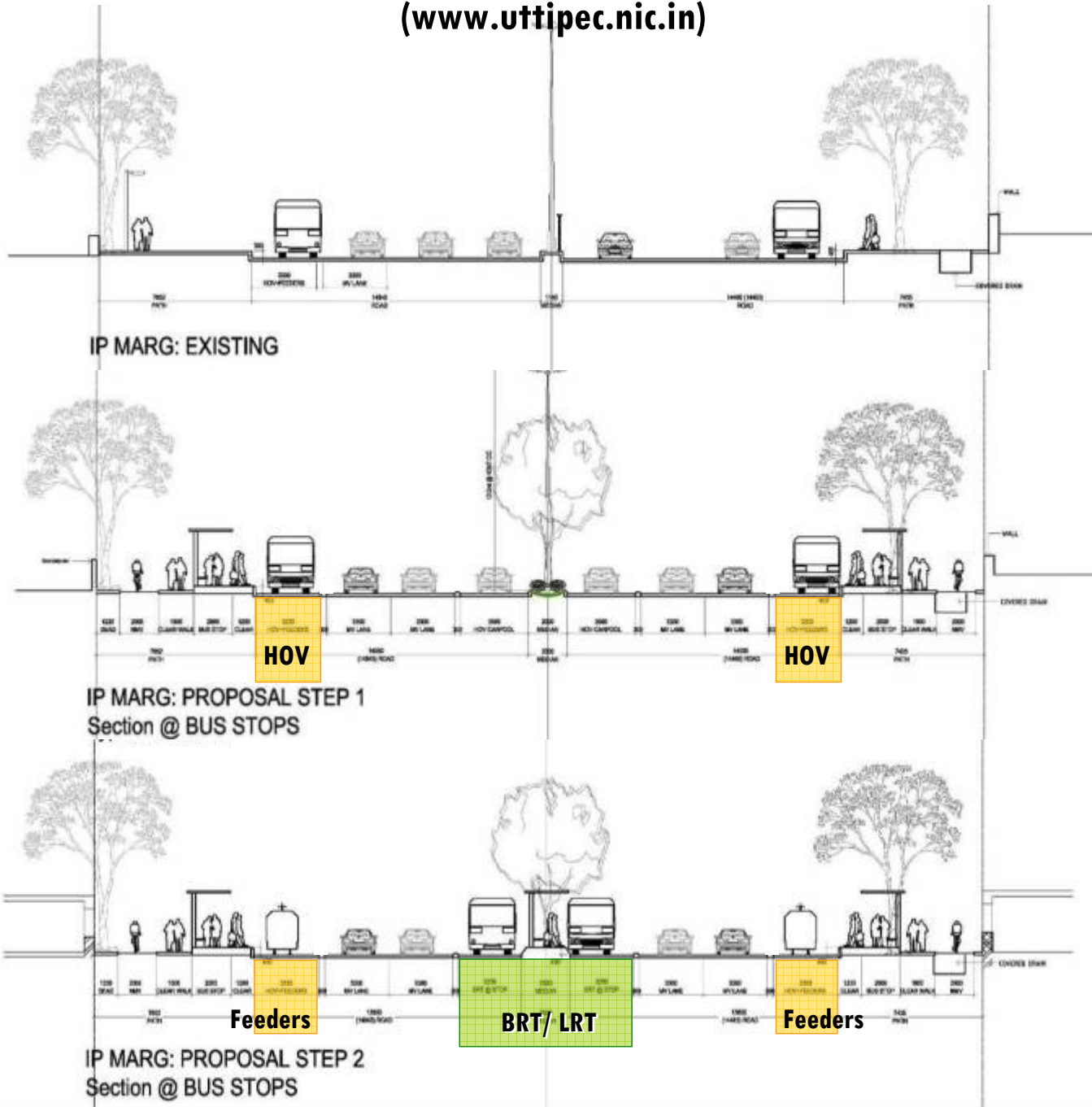



IP Marg at ITO, Delhi

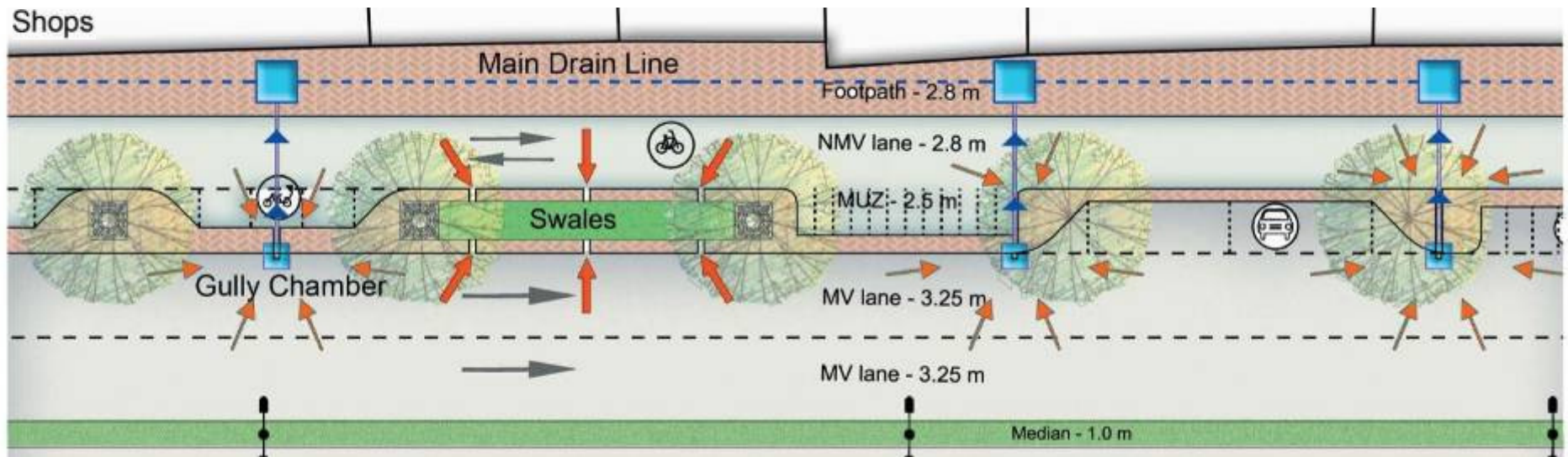

Annexure – I: Storm Water Management and Rain Water Harvesting in Street Right-of-Ways

Typical Street-edge Plan showing flow of surface (rain) water into Swales – from the carriageway as well as the footpaths/ cycle tracks.



-  Gully Chamber
-  Main Drain Line

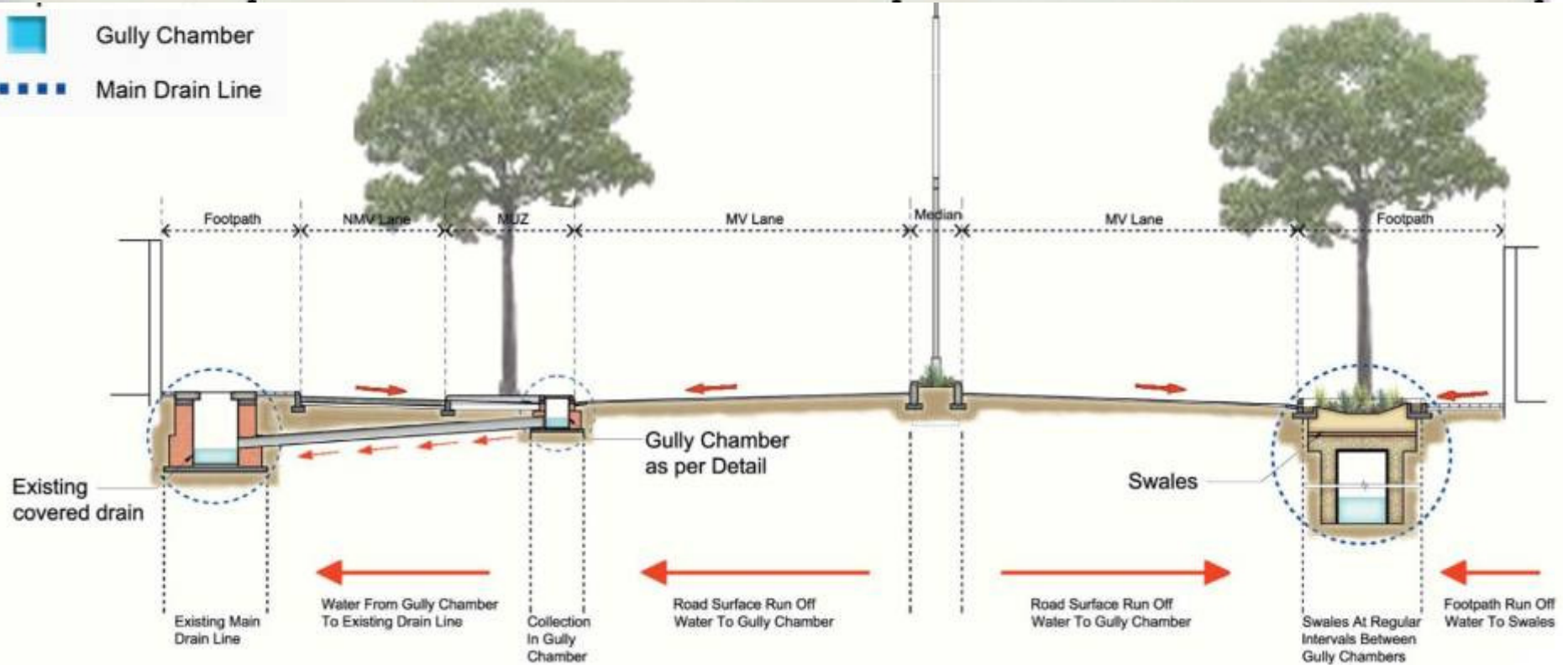

Annexure – I: Contd.

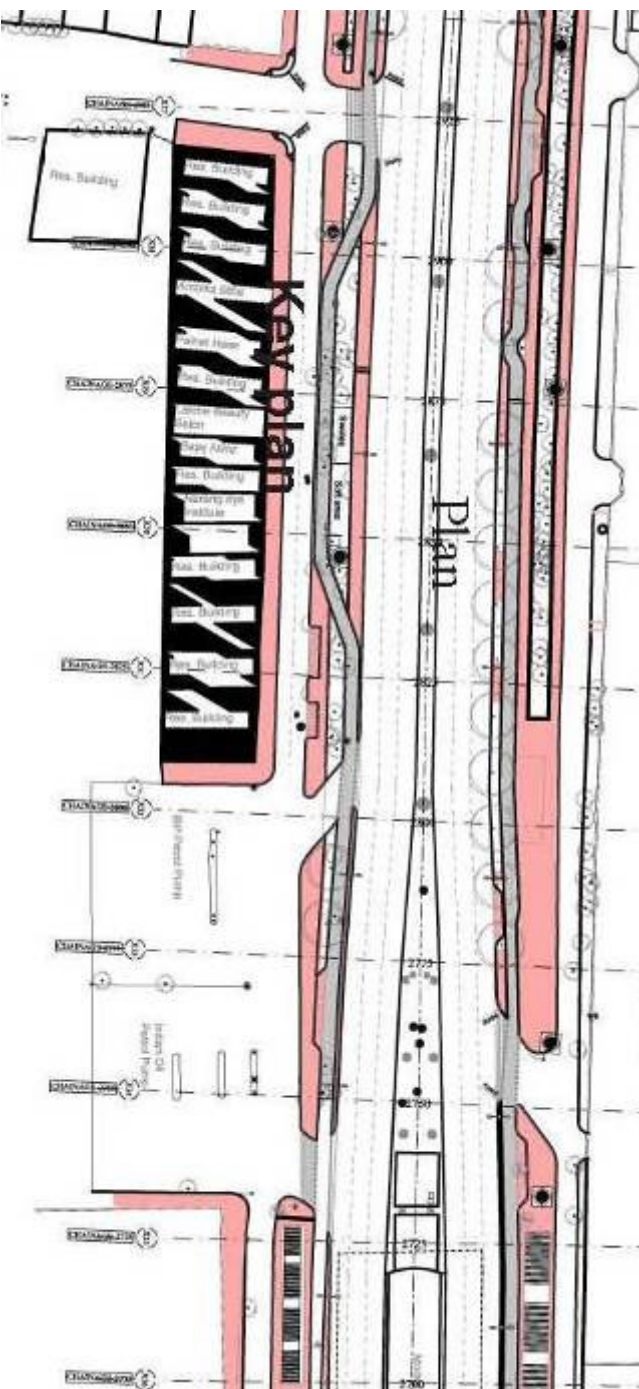

Water Management calculations for 500 metres road: Delhi University area, Grid X20 to X41

	width	length	area(sqmt)		
1.00 Road area/ paved area, (six MV lanes of 3.25mts+ 2 nos NMV lane of 2.6 mts and 2nos Foot path of 3.0 mts)	30.7	500	15350		
2.00 Semi soft areas, (median, MUZ etc)	7	500	3500		
3.00 volume of water received from roads area of catchment x amount of rain fall (0.6m in Delhi)	15350	0.6	9210 Cumt		
4.00 volume of water received from median and MUZ	3500	0.6	2100 Cumt		
5.00 assuming 70% of rain water from roads is available for harvesting			6447 Cumt	6447000	Its
6.00 assuming 30% of rain water from MUZ is available for harvesting			630 Cumt	630000	Its
7.00 Total water available for Harvesting (A)			7077 Cumt	7077000	Its
8.00 On a thumb rule, one Harvesting Pit can receive rain water from 200 sqmts of road area. (as per CSE study in DU area)	200	0.6	120 Cumt	120000	Its
9.00 Number of rain water harvesting pits required to Discharge 7077 KL rain water say			58.975		
			60		
Recharge pit Calculations					
Delhi peak rainfall per hour	90	mm			
Peak rainfall for 15 minutes	22.5	mm	0.0225 mts		
max catchement area per Recharge well = 200 sq r	200	sqmt			
Runoff coefficient	0.7				
Size of the pit = catchement area x Peak rain fall for 15 mins x runoff coefficient	3.15	cumt			
Size of Rain water Recharge Holding pit	1.5x1.5x1.4	mts			

Sample Calculations for Water Management/ Rain Water Harvesting on Streets

Source: Pradeep Sachdeva Design Associates, Nov 2009

Annexure – II: References

References:

1. Ministry of Urban Development; *National Urban Transport Policy* (2006)
2. Delhi Development Authority; *Master Plan for Delhi -2021* (2001)
3. IRC:103-1988 *Guidelines for Pedestrian Facilities* (1988)
4. IRC:11-1962 *Recommended Practice for the Design and Layout of Cycle Tracks* (1962)
5. Ministry of Housing and Urban Poverty Alleviation, *National Policy For Urban Street Vendors* (2009)
6. Gandhi, S., Arora, A., Varma, R., Sheth, Y., Sharma, S., Jawed, F., Interface for Cycling Expertise, *Manual for Cycling Inclusive Urban Infrastructure Design in the Indian Subcontinent* (2009)
7. Aggarwal, A., Samarthayam; *Guidelines for Inclusive Pedestrian Facilities*, Report for IRC (2009), TRIPP, IIT Delhi, *BRT Design Specifications* (2009)
8. Centre for Science and Environment, *Footfalls: Obstacle Course to Livable Cities, Right to Clean Air Campaign*, (2009)
9. San Francisco Planning Department, Mayor's Office on Disability, SFMTA; *San Francisco Better Streets Plan - Policies and Guidelines for the Pedestrian Realm* (2008)
10. City of Seattle, *Seattle Right of Way Improvement Manual* (2007)
11. New York City Department of Transportation; *Street Design Manual* (2009)
12. Federal Highway Administration (FHWA) *University Course on Bicycle and Pedestrian Transportation* (2006)
13. U.S. Environmental Protection Agency, *Heat Island Reduction Initiative* (2009)
14. Pradip Krishen, *Trees of Delhi : A Field Guide*, Penguin (2006)
15. American Association of State Highway and Transportation Officials, *Pedestrian and Bicycle Safety* (2008)
16. City of Los Angeles, Department of City Planning, *Cornfields/Arroyo Seco Specific Plan* (2008)
17. City of San Jose: Department of Transportation, *Traffic Calming Toolkit* (2001)
18. New Delhi Municipal Council, Report on Common Utility Ducts in NDMC Area, submitted to UTTIPEC and Hon'ble LG (2009)
19. Transportation Association of Canada, *Draft Canadian Guide to Neighbourhood Traffic Calming*, (1998)
20. The Industrial Resources Council, *Promoting Sustainable Use of Industrial Materials in Hot Mix Asphalt* (2008)
21. Partnership for Advancing Technology in Housing, *Technology Inventory: Accelerating Awareness of Housing Innovations* (2008)
22. Toolbase Services, *The Home Building Industry's Technical Information Resource* (2009)
23. Construction Specifications Institute Magazine, *The Building Brick of Sustainability* (June, 2009)
24. Rubber Sidewalks, Inc., Rubber Sidewalk Fact Sheet (2008)
25. Government of Seattle, *Seattle Right of Way Improvement Manual* (2008)
26. US Environmental Protection Agency, *National Pollutant Discharge Elimination Systems* (2009)
27. AJ McCormack & Son, Paving and Hardscape Advice, PavingExpert.com (2009)

Abbreviations:

NMT : Non Motorized Transport

NMV : Non Motorized Vehicle

MV : Motorized Vehicles

MRTS : Mass Rapid Transport System

BRTS : Bus Rapid Transit System

IRC : Indian Road Congress

DDA : Delhi Development Authority

MOUD : Ministry of Urban Development

ICE: Interface for Cycling Expertise

TRIPP: Transport Research and Injury Prevention Programme

GHG: Green House Gas

Note: The term "Kerb" used in the document could also be referred to as "Curb".

Annexure – III: Working Group Members

Members of WORKING GROUP I-A (DEVELOPMENT OF PLANNING GUIDELINES)

S.No List of officers

Designation/Office Address

1.	Sh. Sanjiv Sahai	MD (DIMTS), Chairman
2.	Sh. Ashok Kumar	Commr.(Plg.) DDA, Co-Chairman
3.	Sh. J.B. Kshirsagar	Chief Planner- Town & Country Planning Organization (TCPO),Member.
4.	Sh. V.K. Bugga	Chief Town Planner, MCD, Member
5.	Sh. R P Indoria	Secretary General, Indian Roads Congress (IRC), Member
6.	Sh. S. Gangopadhaya	Head (T&T)- Central Road Research Institute (CRR), Member
7.	Sh. Kumar Keshav	Director (Projects)- Delhi Metro Rail Corporation (DMRC), Member
8.	Dr. Ashok Kumar Saroha	Director (Urban Transport), MOUD, Member
9.	Representative	Ministry of Surface Transport (GOI), Member
10.	Sh. R.S. Minhas	Sr. Manager (Tr.) – Delhi Transport Corporation (DTC), Member
11.	Sh.Rakesh Mishra	Engineer – in – Chief, PWD, Member
12.	Sh. Ravi Dass	Engineer – in – Chief, MCD, Member
13.	Sh. V.L. Patankar	Member (Technical), National Highway Authority of India, (NHAI)Member
14.	Sh. Vijay Anand	Chief Engineer (Const.) – Northern Railway, Member
15.	Sh. Satyendra Garg	Jt. Commr. Of Police (Traffic)-GNCTD, Member
16.	Sh. Rohit Baluja	President – Institute of Road Training Education (IRTE), Member
17.	Smt. Sunita Narain	Director – Centre for Science and Environment (CSE), Member
18.	Sh. S.S. Mathur	Ex. Secretary General ,Nominee of Secretary – ITPI, Member
19.	Sh. B.S. Diwan	Secretary – Institute of Urban Transport Member (IUT)
20.	Sh. Ramesh Raina	Chief Engineer – New Delhi Municipal Council (NDMC), For Engineer in Chief, Member
21.	Sh.N.R.Aravind	Deputy Director (Plg) UTTIPEC, convener

Annexure – III: Working Group Members

Planning for Pedestrians – Design Guidelines: Sub Group Members:

1. Sh Sharad Varshney, Addl. (Dir.) Technical, IRC (Nominated)
2. Sh. R.Shri Niwas Associate Town & Country Planner (TCPO) (Nominated)
3. Sh. P.S. Uttarwar, Dir.(Plg.)UC, DDA
4. Ms M.Z. Bawa, Director(Plg.) MPPR,DDA
5. Sh. Simon Bishop, Consultant, DIMTS
6. Sh. Pradeep Sachdeva, Architect, Consultant
7. Ms. Anjlee Aggarwal, Executive Director, Samarthyam
8. Ms. Romi Roy, Sr. Consultant, UTTIPEC
9. Sh. Ashok Bhattacharjee, Director (Plg) UTTIPEC
10. Sh. N. R. Aravind, Deputy Director (Plg.) UTTIPEC, Convener
10. Nominated members of MCD, PWD, NDMC, Traffic Police

Special Invitees : (Contributors)

1. Sh. B. K. Jain, A.C. (Plg.) TC&B, UTTIPEC DDA
2. Sh. Ashok Bhattacharjee, Director (Plg.) UTTIPEC
3. Sh. Pramod Behera, Jt. Dir. (Plg.) UTTIPEC
4. Sh. Sabyasacchi Das, Dir (GIS & Website)
5. Sh. Sandeep Gandhi, SG Architects, Consultant
6. Sh. Akash Hingorani, Oasis Designs, Consultant
7. Ms. Anumita Roy Choudhary, Associate Director, CSE
8. Dr. Anvita Arora, Transport Planner

Others:

1. Sh. A.K. Saini, A.D.(Plg.)UTTIPEC
2. Sh. Jeevan Babu, Planning Assistant, UTTIPEC

Annexure – IV: UTTIPEC Street Design Checklist – for Approval of Projects

Decision of Governing Body Meeting held under the Chairmanship of Hon'ble LG on 18.03.2010:

For the Roads (already) taken up for development, (or to be taken up subsequently), the adherence to UTTIPEC Pedestrian Design Guidelines is to be checked by the E-in-C/C.E. concerned. All projects are to adhere to and follow the following Checklist provided.

Notes: The Street Design CHECKLIST is to be read in combination with the Pedestrian Design Guidelines, downloadable from the UTTIPEC Website.

Street Design Guidelines - UTTIPEC			Street Type
S.No.	Component/Sub-Component	Non-negotiable Requirement	
1) Walking Zone: Clear Walking Zone should be 1.8 M x 2.4 M High			
	01A) Minimum Clear Walking Zone	1.8 M clear width 2.4 M Clear height (No obstructions allowable within this clear height. Tree branches within this height to be pruned with due permissions. All Advertisement panels, posts, poles, junction boxes, public utility structures etc. to be removed.)	AI
	01B) Walking Zone Width is provided as per landuse	2.0 M for Residential Areas 2.5 M minimum for Commercial/Mixed Use Streets 4.0 M for Commercial Nodes	AI
	01C) Maximum Kerb Height	Maximum height of a pavement (including kerb, walking surface, top-of-swing) shall not exceed 150 MM (6"). 100 mm (4") kerb height is preferable for Arterial Roads <ul style="list-style-type: none"> All walking surfaces should be very rough/ mat-finish/ anti-slip Medians should be maximum 150mm high or be replaced by crash barriers. In case the carriage way finished level is expected to rise during future re-carpeting, reduction in footpath level to 100 mm or less is acceptable. But under no circumstances is the height of footpath to exceed 150 mm. Finished top level and kerb height for all bus-stops to be 150 mm. Only along Segregated Busways/ BRT corridors, the kerb height of the Bus Stop could match the height of the bus floor. 	AI
	01D) Kerb Radius and Slip Road Treatment	<ul style="list-style-type: none"> Maximum corner radius of Kerb = 12 M It may be reduced to 6 M in residential areas to slow down turning buses, trucks etc. with the provision of a corner mountable kerb for emergency vehicles. Slip roads or Free Left Turns should be avoided. For intersections of R/Ws of 30m-30m or lesser, Slip Roads should be removed/ not considered. In cases where they already exist for intersections for intersection of 30m-45m and higher R/Ws, the following Strategies may be employed: Option 1: Slip Road can be removed wherever Pedestrian and M/W volumes are high Option 2: Reduce Corner Radius of kerb to calm traffic, and signalize the Slip road crossing full or partial signal, in order to make them safe for all users. Option 3: Introduce raised table top crossings at slip roads and minimum 20 second pedestrian signals – to allow pedestrians, cyclists and physically challenged people to cross the road comfortably at the same level Option 4: Signalized Turning Pockets may be provided where left-turning volumes are high. 	As specified.
	01E) Continuous Pavement	<ul style="list-style-type: none"> Continuous barrier free movement corridor for M/Ws and Persons with Disabilities. Avoid sidewalk interruptions by minimizing kerb cuts i.e. Minimize the number of driveways that cross the sidewalk – in order to support pedestrian safety and a continuous sidewalk. Maintain an even surface and elevation of the pavement at 150.0MM or less from surrounding road level. At entry points of properties – introduce "raised driveway" or "table-top" details – where pedestrian and cycle lanes continue at their same level, but the motorized vehicles have to move over a gentle ramp to enter the property. Remove all obstructions from the sidewalks. Consistency of design elements, color and texture, help provide visual continuity and calm traffic, even at crossings. 	AI
	01F) High Albedo Materials	If paving with asphalt, applying a white aggregate as a chip seal layer, or a light-colored surface coating such as a zinc-oxide slurry mix.	AI
	01G) Permeable Pavement	Paving for large hard surfaced areas like parking lots, driveway curb cuts, large plazas, hawker zones, pedestrian only streets, etc. should be permeable in order to reduce runoff and heat island effect, and increase ground water infiltration and recharge.	Wherever large paved areas exist.
	Guard-Rail	Not desirable in most instances on urban roads, except near intersections.	

Annexure – IV: UTTIPEC Street Design Checklist – for Approval of Projects

2	<p>Frontage Zone or "Dead Width"</p> <ul style="list-style-type: none"> For sidewalks in shopping areas, an extra 1M should be added to the stipulated 4.00 M width. This extra width is called "Dead Width". In other situations where sidewalks pass next to buildings and fences, a dead width of 0.5 M can be added. In busy areas like bus stops, railway stations, recreational areas, the width of sidewalk should be suitably increased to account for accumulation of pedestrians. 		All Commercial and Mixed-use Streets
3	<p>Universal Accessibility Features/ Barrier Free Design</p> <p>Please see Guidelines Document for Details. http://uttipee.nic.in/StreetGuidelines-R1-Feb2011-UTTIPEC-DDA.pdf</p>	<p>Universal Accessibility is required for all sidewalks, crossings, parks, public spaces and amenities.</p>	
	<p>03A) Kerb Ramps</p> <p>03B) Raised Table-Top Crossings</p> <p>03C) Tactile Paving</p> <p>03D) Auditory Signals</p> <p>03E) Accessible Infrastructure</p>	<p>1:12 Minimum Slope at all level change points; 1:2 M Width of Ramp; Tactile warning strip to be provided at curbside edge of the slope.</p> <p>All slip road pedestrian crossings; all non-signalized intersections and mid-block intersections should be raised to match the level of the connected footpaths (150 mm top of Kerb).</p> <p>All walking surfaces should have Tactile pavers (Guiding and warning path) to guide people with vision impairment.</p> <p>Tactile pavers should be provided to lead persons with vision impairments to the lifts, crossings, toilets, bus stops, i.e. all public and raised facilities.</p> <p>All traffic signals should have red & green men symbols and auditory signals.</p> <p>All Signage should be graphic or symbol based, rather than text based.</p> <p>Lifts should be minimum 1400 x 1400 Mm in size.</p> <p>All Lifts to have Braille buttons and audio announcement systems.</p>	<p>All</p> <p>All</p> <p>All</p> <p>All</p> <p>All</p> <p>Wherever applicable</p> <p>Wherever applicable</p>
4	<p>Multi-Functional Zone with Planting</p> <p>Multi-Functional Zones on a Street should be a minimum of 1.8 M Wide, and may locate any or all of the following functions within them:</p> <p>Tree Planting; Planting for Storm Water Management; Auto-rickshaw Stands; Cycle-rickshaw Stands; Hawker Zones; Car Parking; Street Furniture; Bus Stops; Street lights/ pedestrian lights.</p> <p>Provision of MFZ is most critical otherwise the above uses/ components of streets would encroach upon pedestrian, cyclist or carriage way space.</p> <p>Common Utility Ducts and Duct Banks should not be located under the MFZ as there may be interference due to trees.</p>		
	<p>04A) Essential Planting</p> <p>04B) Tree Pits and Tree Grates</p> <p>04C) Planting with Storm Water Management</p> <p>04D) Aesthetic Planting</p>	<p>Deciduous Trees a must for shading and comfort of all road users in different seasons.</p> <p>Tree Planting and Lighting Plan must be prepared in conjunction so as to not obstruct each other.</p> <p>Trees must be pruned up in order to maintain visual clearance for pedestrians (2.4 M clear vertical zone).</p> <p>Under no circumstances should trees be placed within the 1.8 M clear horizontal walking zone.</p> <p>1.8 M x 1.8 M Tree Pit should be left for Tree roots to breathe, Permeable Pavers or Tree Grates should be placed over the pit in busy pedestrian streets so people can walk over the tree pit.</p> <p>Rain water harvesting is a must on all roads, and all road retrofitting projects.</p> <p>Trees themes by color of flowers, foliage, fruit-type, smells, and other aesthetics qualities in order to give a unique experience to road users</p>	<p>All Streets above 6 M width</p> <p>All</p> <p>All</p> <p>All</p> <p>All</p> <p>All</p> <p>As feasible and suitable</p>

Annexure – IV: UTTIPEC Street Design Checklist – for Approval of Projects

5	Bicycle and NMT Infrastructure	Minimum 2.5 M NMT Path made in Cement Concrete and physically separated from MW	All two-way Streets above 24 M
05A	Segregated Cycle +NMT Paths	Cycle and NMT Path in cement concrete, physically separated from Motorized vehicle traffic by an open space or barrier within the existing Right-of-Way	All
05B	Bicycle Parking and Other Infrastructure	Secure Cycle Parking must be provided at all MRTS/BRIS Stations. Designated cycle-rickshaw parking is to be provided near all local and mass transit stops. Cycle parking and cycle rickshaw parking should be accommodated within the Multi-Functional Zone; minimum width required is 4.5 M. The stands should allow at least the frame and ideally both wheels, to be secured to them.	All All All
	Cycle Track - Capacity	Capacity in number of cycles per day Two Lane - 2.5 to 5.0 M Three Lane - Over 5.0 M Four Lane - -----	All
	For One way Traffic	Two Lane - 2.5 M MIN/M Three Lane - 2000 to 5000 Four Lane - Over 5.0 M	All
	For Two Way Traffic	Two Lane - 2.5 M MIN/M Three Lane - 2000 to 5000 Four Lane - Over 5.0 M	All
	Cycle Track - Types	Two types of cycle tracks: 1 Which run parallel to, or along a main carriage way A. Adjoining Cycle Tracks B. Raised Cycle Tracks C. Free Cycle Tracks 2 Which are constructed independent of any carriage way	All
	Cycle Track - Horizontal Curves	It should be so aligned that the radii of the horizontal curves are not less than 10 M (33 ft). Where the track has a gradient steeper than 1 in 40 , the radii of the horizontal curves should not be less than 15 M (50 ft). The radii of horizontal curves for independent cycle tracks should be as large as practicable.	All
	Cycle Track - Vertical Curves	Vertical curves at changes in grade should have a minimum radius of 200 M (656 ft) for summit curves and 100 M (328 ft) for valley curves.	All
	Cycle Track - Gradients	The length of grade should not exceed from 90 M (295 ft) to 500 M (1640 ft) for the gradient of 1 in 30 to 1 in 70, respectively. Gradients steeper than 1 in 30 should generally be avoided. Only in exceptional cases, gradients of 1 in 20 and 1 in 25 may be allowed for lengths not exceeding 20 M (65 ft) and 60 M (164 ft) respectively. Where the gradient of a carriageway is too steep for a parallel cycle track the latter may have to be taken a long a detour to satisfy the requirements of this standard.	All
	Cycle Track - Sight Distances	Cyclist should have a clear view of not less than 25 M (82 ft). In the case of cycle tracks at gradients of 1 in 40 or steeper , cyclist should have a clear view of not less than 60 M (197 ft).	All
	Cycle Track - Lane width	The total width of pavement required for the movement of one cycle is 1.0 M (3 ft 3 in.).	All
	Cycle Track - Width of Pavement	The minimum width of pavement for a cycle track should not be less than 2 lanes, i.e., 2.0 M (6 ft 6 in.). If overtaking is to be provided for, the width should be made 3.0 M (9.8 ft). Each additional lane where required should be 1.0 M (3 ft 3 in.) wide.	All

Annexure – IV: UTTIPEC Street Design Checklist – for Approval of Projects

	<p>Cycle Track - Clearance</p> <p>Vertical clearance - The minimum head-room provided should be 2.25 M (7.38 ft).</p> <p>Horizontal clearance - At underpass and similar other situations a side clearance of 25 cm should be allowed on each side.</p> <p>The minimum width of an underpass for a two-lane cycle track would, therefore, be 2.5 M (8.2 ft). In such situations it would be desirable to increase the head room by another 25 cm so as to provide a total vertical clearance of 2.5 M (8.2 ft).</p> <p>Cycle Track - Cycle tracks on bridges</p> <p>Full width cycle tracks should be provided over the bridge.</p> <p>The height of the railing or parapet should be kept 15cm higher than required otherwise, when cycle track is located immediately next to bridge railing or parapet.</p> <p>Cycle Track - General</p> <p>Provided on both sides of a road and should be separated from main carriageway by a verge or a berm.</p> <p>Minimum width of the verge - 1.0M (3ft 3in.)</p> <p>Width of verge may reduced to 50cm (20 in.).</p> <p>For a width of 50cm (20 in.) from the edge of the pavement of the cycle track, the verge or berm should be maintained so as to be usable by cyclists in an emergency.</p> <p>Cycle tracks should be located beyond the hedge, tree, or footpath.</p> <p>Kerbs should be avoided as far as possible.</p> <p>A clearance of at least 50 cm should be provided near hedges and of 1.0 M from trees or ditches.</p> <p>Where a cycle track crosses a road, the carriageway should be marked with appropriate road markings.</p> <p>Cycle tracks should have riding qualities and lighting standards equal to or better than those of the main carriageway, to attract the cyclists.</p>	
<p>6</p>	<p>Crossings</p> <p>Minimum 3 M wide pedestrian crossing and 2.5 M wide cycle crossing must be provided at all road crossings.</p> <p>A "Set of 3" essentials components are required at each crossing:</p> <p>1) Universal Accessibility Features (for persons with disabilities, reduced mobility, vision and hearing impairment)</p> <p>2) Dustrain</p> <p>3) Street Directional Signage</p> <p>06A) At-grade Crossing</p> <p>Minimum 3 M wide signalized crossings at all intersections and T-junctions</p> <p>Width of crossing should be increased where higher pedestrian/VMT volumes are expected due to abutting landuses</p> <p>Advance stop and yield lines should be considered at stop- or signal-controlled marked crossings with limited crossing visibility, poor driver compliance, or non-standard geometrics.</p> <p>Stop and yield lines can be used from 1 to 15 M in advance of crossings, depending upon location, roadway configuration, vehicle speeds, and traffic control.</p> <p>Traffic Calming Treatment starting least 25 m before the zebra table-top crossing is essential in Delhi due to unruly traffic.</p> <p>Wayfinding Signage for Pedestrian orientation and directional guidance must be provided at street intersections. American-like distances are also needed. (Section 10)</p> <p>06B) Mid-Block Crossing</p> <p>Mid-block crossings must be provided for blocks longer than 250 M. See Guidelines Document for Details.</p> <p>Mid-block crossings must be provided at regular intervals as per the following standards:</p> <p>Residential Areas: Every 80 - 250m and Coordinated with entry points of complexes, location of bus/train stops, public facilities, etc.</p> <p>Commercial/Mixed Use Areas: Every 80 - 150 m</p> <p>High Intensity Commercial Areas: Make Pedestrian and NMT only, if possible.</p> <p>All non-signalized mid-block crossings are to have auditory pelican signals and table top provisions.</p>	<p>All</p> <p>All</p> <p>All, except highways</p>

Annexure – IV: UTTIPEC Street Design Checklist – for Approval of Projects

06C	Raised Crossings	(see 03E)	All, except highways
06D	Grade Separated Crossing (Foot Over Bridge)	<p>Foot Over-bridges may be considered only on highways and in Special Conditions where no other solutions for Crossing are possible.</p> <p>All Subways and Foot-overbridges must have a combination of either 'Staircase + Ramp' or 'Stair/Case + Elevator' for universal accessibility.</p>	See "FOB Consideration & Design Checklist" on UTTIPEC Website.
06E	Grade Separated Crossing (Humped Crossing)	<p>Humped Crossings may be considered only on highways.</p> <p>Clear height of Humped crossing is 2.7 M; the road above is raised by 1.5 M and the pedestrian walkway is sunk by 1.2 M.</p> <p>Rainwater harvesting is mandatory and critical.</p>	Only Highways or Special Conditions
7	Medians, Refuge Islands - see SF	Medians and Pedestrian Refuge Islands are a must on streets wider than 24 M.	All Streets above 24 M
07A	Landscaped Median	Instead of fences, Medians should be landscaped and used for stormwater management wherever possible.	All Streets above 24 M
07B	Pedestrian Refuge Island at Median	When street trees are desired, a median should be min. 1.5 M wide, including kerbs.	All Streets above 24 M
8	Pedestrian Scale Lighting	<p>At-grade Median Refuges allow pedestrians to walk safely for crossing wide streets with long signal rotations.</p> <p>Minimum Width of a Pedestrian Refuge Island at a Crossing is 12 M, enough to accommodate a wheelchair or stroller. Barbs must be used to prevent vehicular U-turns.</p> <p>Mid-Mast Lighting (10-12 M tall) – are appropriate for most Arterial and Sub-Arterial Streets. For Wide Streets with high pedestrian/ commercial activity, Mid-Mast lighting may be combined with Pedestrian Scale lighting to create additional security and comfort.</p>	
08A	Pedestrian Scale Low-Mast Street Lighting	Height of Light Pole is a function of Street Width. Narrower the Street Width, lower can be the Lamp Height.	All
08B	Full Cut-off Fixtures	The lux level for the street lighting may be applied as per NEERC standards.	All
10	Public Amenities (Toilets, etc), Hawker Zones, Signage	Lighting Plan must be prepared in conjunction with Tree Planting Plan.	
10A	Local Bus Stop	Full cut off fixtures which focus light downwards and allow no light towards the night sky, and also do not cause glare – are required for all public streets.	All
10B	Public Toilets	Public Toilets, including one for persons with disabilities - must be located every 600- 800 M.	All
10C	Street Direction Signage	Vector Wayfinding Signage is essential at every street corner.	All, as feasible
10D	Pelican Signals	Auxiliary Pelican Signals coupled with raised table top crossings must be provided at all T-junctions and non-fully signalized mid-block crossings.	All
10E	Dustbins	Dustbins with graphic explanation of source separation, must be provided at all street intersections and bus-stops.	All
10F	Hawker Zones	Hawker Zones must be provided within the Multi-functional Zone or other incidental spaces along a pedestrian pathway - within the overall Footy - but must be clear of all minimum walking and cycling rights-of-way.	All

In case of all the pedestrian facilities, the issue of regular upkeep and maintenance is vital. Road owning agencies may need to formulate a regime to ensure regular upkeep of footpath surfaces, lighting, signage, amenities, etc.

To involve the local community in the maintenance and upkeep, innovative approaches of financing the upkeep and maintenance of roads need to be explored.

